



# BAS40TS

## SURFACE MOUNT SCHOTTKY DIODES

**VOLTAGE** 40 Volt **CURRENT** 0.2 Ampere

SOD-523

Unit: inch (mm)

### FEATURES

- Fast switching speed
- Surface mount package ideally suited for automatic insertion
- Lead free in compliance with EU RoHS 2011/65/EU directive

AOI friendly, compatible with lead-free solder

### MECHANICAL DATA

- Case: SOD-523, Plastic
- Terminals: Solderable per MIL-STD-750, Method 2026
- Appox Weight : 0.00005 ounces, 0.0014 grams
- Marking : 40
- Polarity : Color band cathode

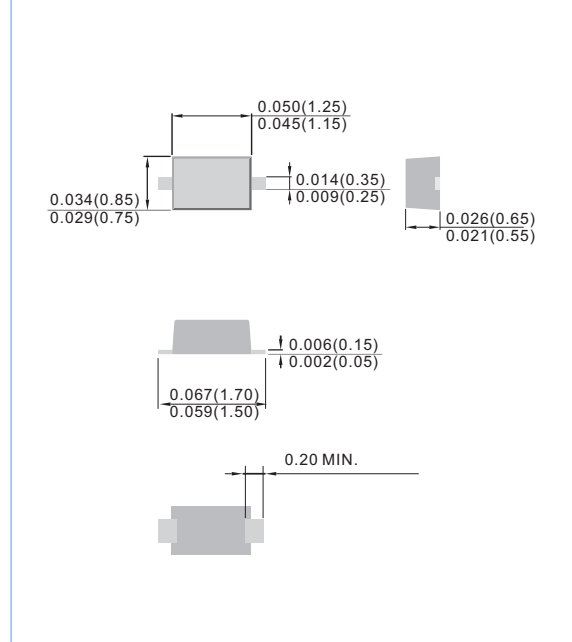

### ABSOLUTE RATINGS (T<sub>A</sub>=25°C, unless otherwise noted)

PARAMETER	Symbol	BAS40TS	Units
Peak Reverse Voltage	V <sub>RRM</sub>	40	V
Average Rectified Current at T <sub>A</sub> =25°C	I <sub>F(AV)</sub>	0.2	A
Non-repetitive Peak Forward Surge Current at t=8.3m s	I <sub>FSM</sub>	0.5	A
Power Dissipation	P <sub>TOT</sub>	200	mW
Junction Temperature	T <sub>J</sub>	125	°C
Storage Temperature Range	T <sub>STG</sub>	-40 to 125	°C

### THERMAL CHARACTERISTICS

PARAMETER	Symbol	BAS40TS	Units
Thermal Resistance, Junction to Ambient	R <sub>θJA</sub>	635	°C/W





## BAS40TS

### ELECTRICAL CHARACTERISTICS ( $T_A=25^{\circ}\text{C}$ , unless otherwise noted)

PARAMETER	Symbol	Test Condition	MIN.	MAX.	Units
Reverse Breakdown Voltage	$V_{(BR)}$	$I_R=10\mu\text{A}$	40	-	V
Reverse Current	$I_R$	$V_R=25\text{V}$	-	1.0	$\mu\text{A}$
Forward Voltage	$V_F$	$I_F=1\text{mA}$ $I_F=10\text{mA}$ $I_F=40\text{mA}$	-	0.38 0.5 1.0	V
Total Capacitance	$C_J$	$V_R=0\text{V}, f=1\text{MHz}$	-	5	pF



# BAS40TS

## ELECTRICAL CHARACTERISTICS CURVE

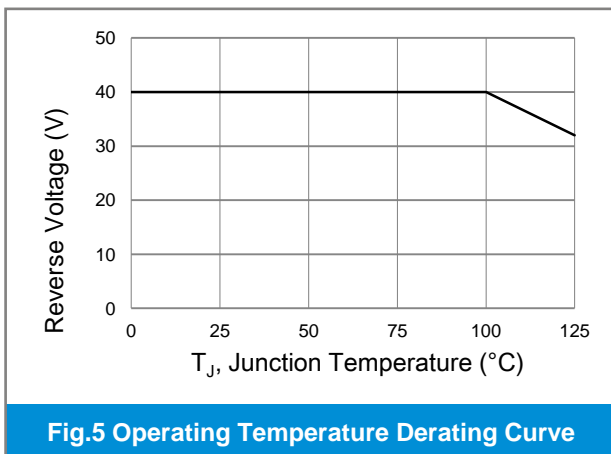
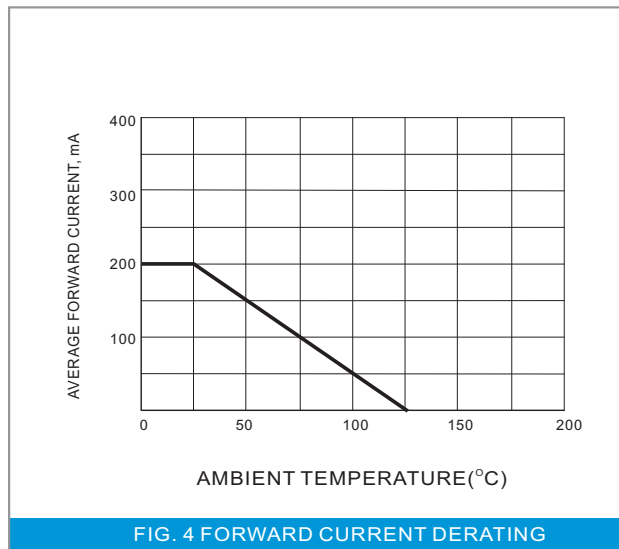
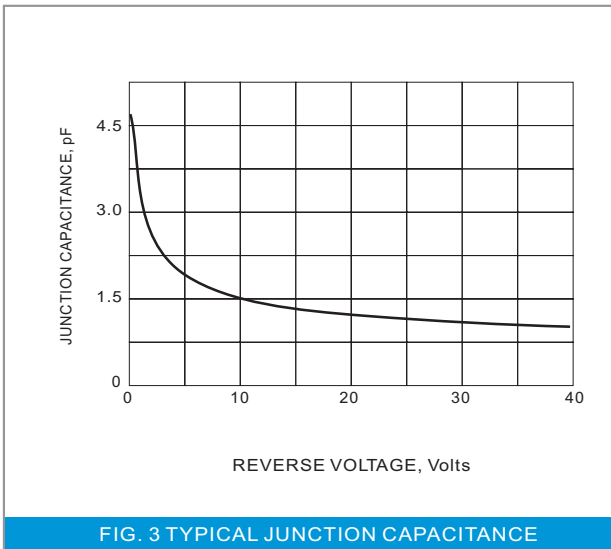
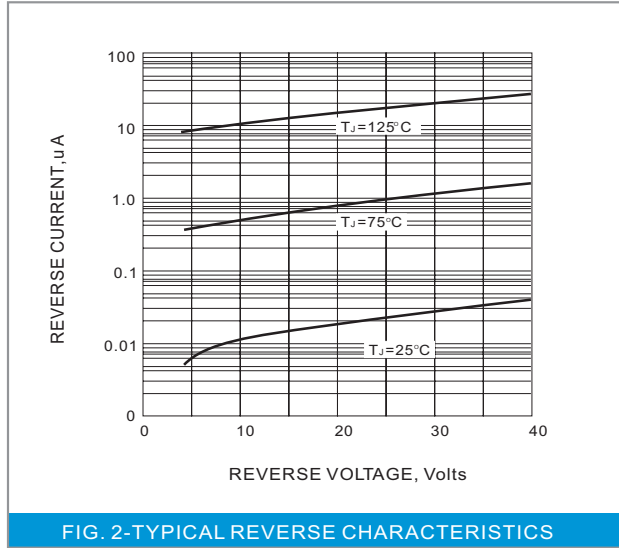
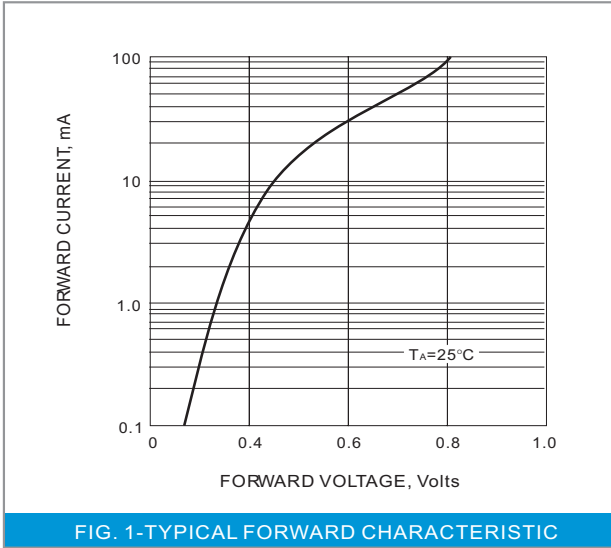



## BAS40TS

### MOUNTING PAD LAYOUT

SOD-523

Unit : inch(mm)

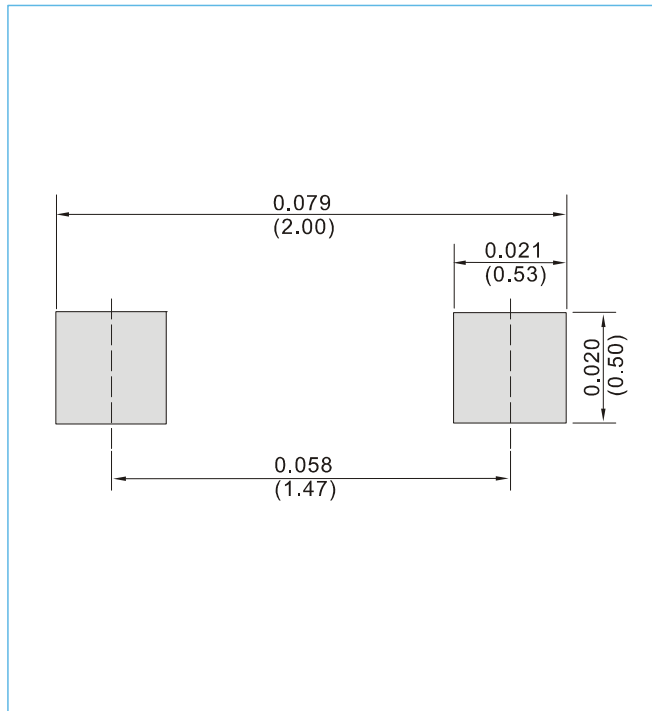

### ORDER INFORMATION

- Packing information
  - T/R - 12K per 13" plastic Reel
  - T/R - 5K per 7" plastic Reel



# BAS40TS

**Part No\_packing code\_Version**

ÓÆÏ €VÙ\_R1\_00001

ÓÆÏ €VÙ\_R2\_00001

For example :

**RB500V-40\_R2\_00001**



Packing Code <b>XX</b>				Version Code <b>XXXXX</b>		
Packing type	1 <sup>st</sup> Code	Packing size code	2 <sup>nd</sup> Code	HF or RoHS	1 <sup>st</sup> Code	2 <sup>nd</sup> ~5 <sup>th</sup> Code
T/B	<b>A</b>	N/A	<b>0</b>	<b>HF</b>	<b>0</b>	serial number
T/R	<b>R</b>	7"	<b>1</b>	<b>RoHS</b>	<b>1</b>	serial number
B/P	<b>B</b>	13"	<b>2</b>			
T/P	<b>T</b>	26mm	<b>X</b>			
TRR	<b>S</b>	52mm	<b>Y</b>			
TRL	<b>L</b>	PBCU	<b>U</b>			
FORMING	<b>F</b>	PBCD	<b>D</b>			



## BAS40TS

---

### Disclaimer

- Reproducing and modifying information of the document is prohibited without permission from Panjit International Inc..
- Panjit International Inc. reserves the rights to make changes of the content herein the document anytime without notification. Please refer to our website for the latest document.
- Panjit International Inc. disclaims any and all liability arising out of the application or use of any product including damages incidentally and consequentially occurred.
- Panjit International Inc. does not assume any and all implied warranties, including warranties of fitness for particular purpose, non-infringement and merchantability.
- Applications shown on the herein document are examples of standard use and operation. Customers are responsible in comprehending the suitable use in particular applications. Panjit International Inc. makes no representation or warranty that such applications will be suitable for the specified use without further testing or modification.
- The products shown herein are not designed and authorized for equipments requiring high level of reliability or relating to human life and for any applications concerning life-saving or life-sustaining, such as medical instruments, transportation equipment, aerospace machinery et cetera. Customers using or selling these products for use in such applications do so at their own risk and agree to fully indemnify Panjit International Inc. for any damages resulting from such improper use or sale.
- Since Panjit uses lot number as the tracking base, please provide the lot number for tracking when complaining.