

MBR1040DC~MBR10200DC

D²PAK SURFACE MOUNT SCHOTTKY BARRIER RECTIFIERS

VOLTAGE 40 to 200 Volt **CURRENT** 10 Ampere

TO-263 / D²PAK Unit : inch(mm)

FEATURES

- Plastic package has Underwriters Laboratory Flammability Classification 94V-O. Flame Retardant Epoxy Molding Compound.
- Low power loss, high efficiency.
- Low forward voltage, high current capability
- High surge capacity.
- For use in low voltage, high frequency inverters free wheeling, and polarity protection applications.
- Lead free in compliance with EU RoHS 2.0
- Green molding compound as per IEC 61249 standard

MECHANICAL DATA

- Case: D²PAK Molded plastic
- Terminals: Solder plated, solderable per MIL-STD-750, Method 2026
- Polarity: As marked.
- Standard packaging: Any
- Weight: 0.049 ounces, 1.38 grams

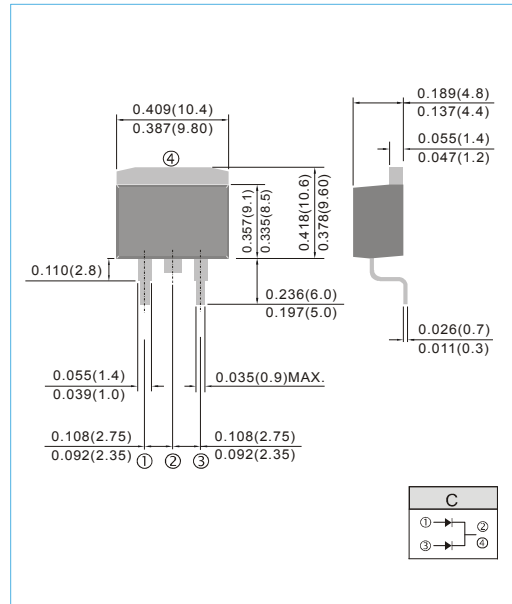

MAXIMUM RATINGS

Ratings at 25°C ambient temperature unless otherwise specified. Single phase, half wave, 60 Hz, resistive or inductive load.

For capacitive load, derate current by 20%

PARAMETER	SYMBOL	MBR1040DC	MBR1045DC	MBR1050DC	MBR1060DC	MBR1080DC	MBR1090DC	MBR10100DC	MBR10150DC	MBR10200DC	UNITS
Maximum Recurrent Peak Reverse Voltage	V_{RRM}	40	45	50	60	80	90	100	150	200	V
Maximum RMS Voltage	V_{RMS}	28	31.5	35	42	56	63	70	105	140	V
Maximum DC Blocking Voltage	V_{DC}	40	45	50	60	80	90	100	150	200	V
Maximum Average Forward (See Figure 1)	$I_{F(AV)}$	10									A
Peak Forward Surge Current : 8.3ms single half sine-wave superimposed on rated load	I_{FSM}	150									A
Maximum Forward Voltage at 5.0A per leg	V_F	0.70		0.75		0.80		0.90			V
Maximum DC Reverse Current at Rated DC Blocking Voltage $T_J=25^{\circ}C$ $T_J=100^{\circ}C$	I_R	0.05 20									mA
Typical Thermal Resistance	$R_{\theta JC}$	3.0									$^{\circ}C / W$
Operating Junction and Storage Temperature Range	T_J, T_{STG}	-55 to +150				-65 to +175					$^{\circ}C$

MBR1040DC~MBR10200DC

RATING AND CHARACTERISTIC CURVES

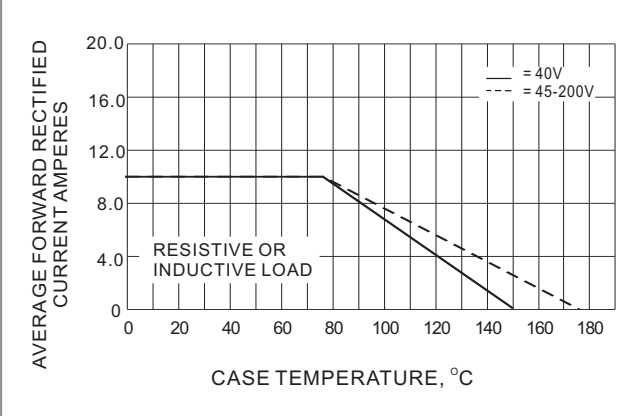

Fig.1 FORWARD CURRENT DERATING CURVE

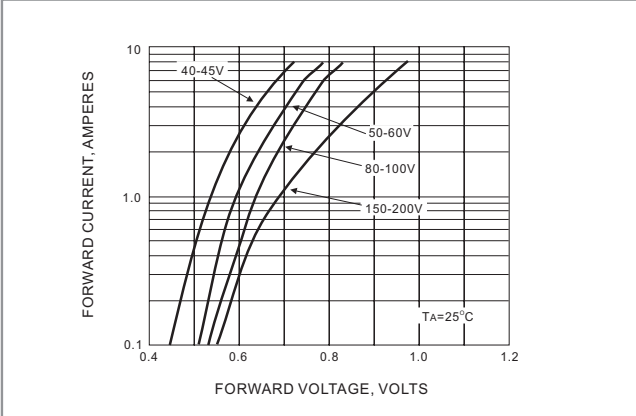

Fig.2 TYPICAL INSTANTANEOUS FORWARD CHARACTERISTIC

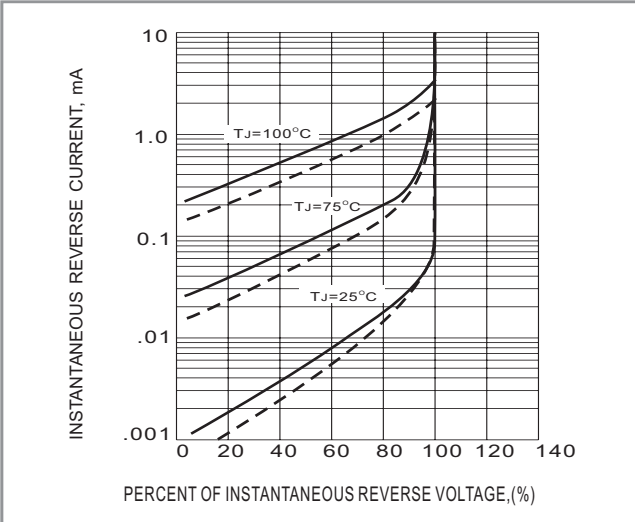

Fig.3 TYPICAL REVERSE CHARACTERISTICS

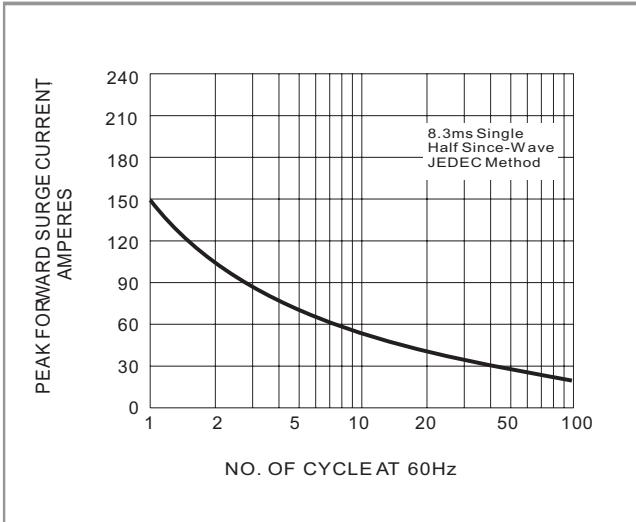

Fig.4 MAXIMUM NON-REPETITIVE SURGE CURRENT

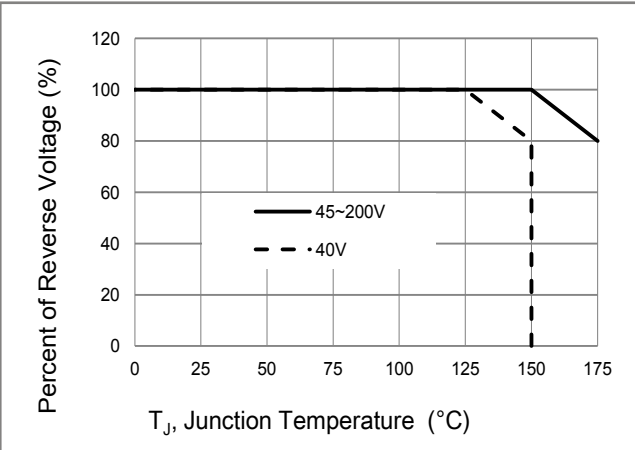

Fig.5 Operating Temperature Derating Curve

MBR1040DC~MBR10200DC

MOUNTING PAD LAYOUT

TO-263 / D²PAK

Unit : inch(mm)

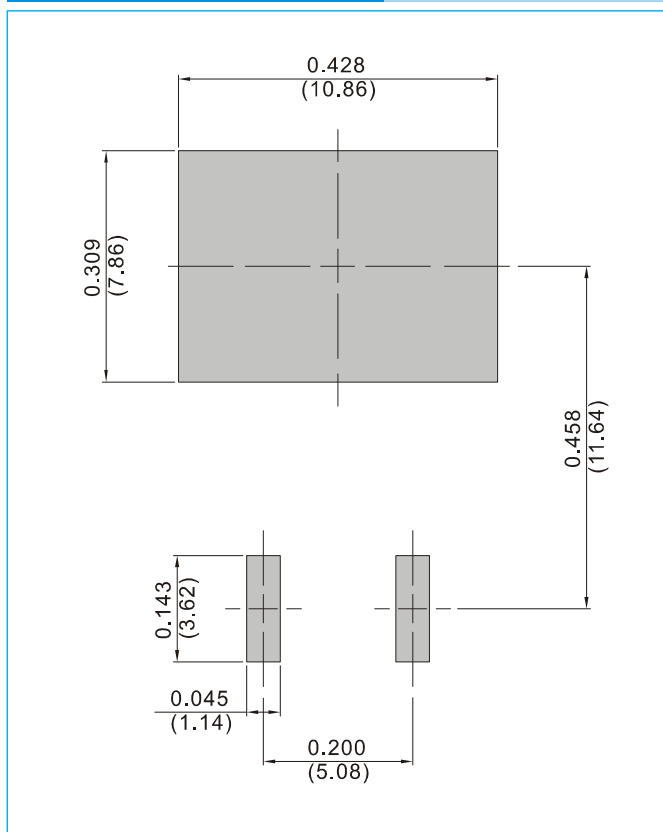

ORDER INFORMATION

- Packing information
T/R - 0.8K per 13" plastic Reel

MBR1040DC~MBR10200DC

Disclaimer

- Reproducing and modifying information of the document is prohibited without permission from Panjit International Inc..
- Panjit International Inc. reserves the rights to make changes of the content herein the document anytime without notification. Please refer to our website for the latest document.
- Panjit International Inc. disclaims any and all liability arising out of the application or use of any product including damages incidentally and consequentially occurred.
- Panjit International Inc. does not assume any and all implied warranties, including warranties of fitness for particular purpose, non-infringement and merchantability.
- Applications shown on the herein document are examples of standard use and operation. Customers are responsible in comprehending the suitable use in particular applications. Panjit International Inc. makes no representation or warranty that such applications will be suitable for the specified use without further testing or modification.
- The products shown herein are not designed and authorized for equipments requiring high level of reliability or relating to human life and for any applications concerning life-saving or life-sustaining, such as medical instruments, transportation equipment, aerospace machinery et cetera. Customers using or selling these products for use in such applications do so at their own risk and agree to fully indemnify Panjit International Inc. for any damages resulting from such improper use or sale.
- Since Panjit uses lot number as the tracking base, please provide the lot number for tracking when complaining.