



PRODUCT



CATALOG

PAN JIT
SEMI
CONDUCTOR

IMPORTANT NOTICE

- a) This Catalog contains the specifications, characteristics, data, materials, and structures of product. The contents are as reference for customer only and ensured to be accurate and reliable with reasonable care. PANJIT does not warrant that such information is error-free and PANJIT shall have no responsibility for any damage arising from inaccuracy or misprint of such information. Please contact with PANJIT for updated information.
- b) Although PANJIT is constantly improving product quality and reliability, a very small percentage of semiconductor products might potentially fail. PANJIT shall not have responsibility for any damage or injury arising from non-compliance with the recommended usage condition and specification contained herein.
- c) The products introduced in this Catalog are intended for use in general electronic equipment (i.e. consumer system, entertainment sets, communication). Please contact and consult with PANJIT if products are intended to use in application requiring high degree of reliability such as transportation system (i.e. cars, aircraft), safety equipment, medical system and power transmission system.
- d) For very strict reliability application, please contact with PANJIT to get advanced information of product application.
- e) If there is any question about contents in this Catalog, please contact with PANJIT or its sales agents before using the product. Neither PANJIT nor its agents shall be liable for any injury caused by any use of the products not accordance with instructions set forth herein.
- f) This document may not be recorded, reprinted, and reproduced without the permission from PANJIT.

TABLE OF CONTENT

Automotive

MOSFETs

Small Signal MOSFETs	003
Low Voltage MOSFETs	004
Medium Voltage MOSFETs	007

SiC Devices

SiC Diodes	008
------------------	-----

Schottky Diodes

Small Signal Schottky	009
Power Schottky	011
Super Schottky	013

Diode Rectifiers

Small Signal Switching Diodes	014
General Purpose Rectifiers	015
Hyper Fast Recovery Rectifiers	017

Bridges

Schottky Bridge Rectifiers	018
----------------------------------	-----

Protection Devices

Zener Diodes	019
ESD Protection	039
Transient Voltage Suppressors	041
Load Dump Transient Voltage Suppressors	053

Bipolar Junction Transistors

General Transistors	054
Low VCE(sat) Transistors	056

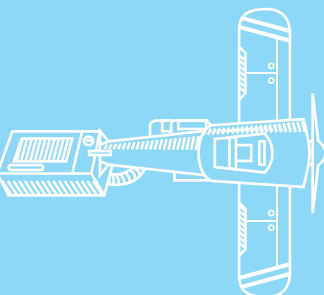
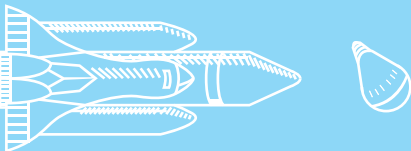
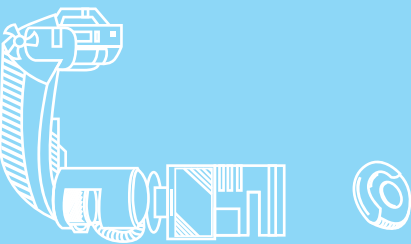
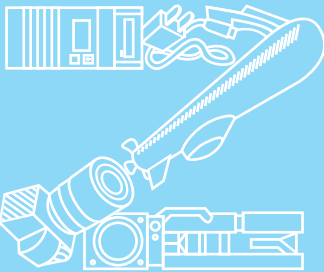
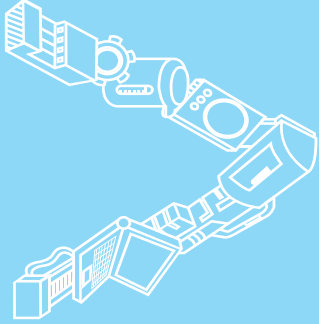
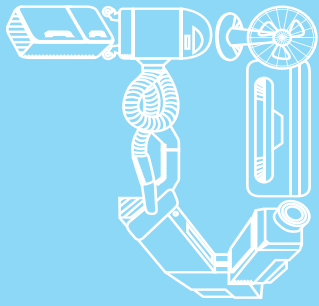

TABLE OF CONTENT

Consumer

Power Management IC

AC-DC Switching Controller	057
Battery Management IC	058
DC-DC Switching Regulator.....	059
LDO	060
Power Switches	061

Signal Chain IC

Amplifier	062
Sensors	063

MOSFETs

Small Signal MOSFETs	064
Low Voltage MOSFETs.....	065
Medium Voltage MOSFETs	069
Super Junction MOSFETs.....	071

IGBT

High Speed IGBT	072
Medium Speed IGBT	072

SiC Devices

SiC Diodes	073
------------------	-----

Schottky

Small Signal Schottky	075
Power Schottky	078
Super Schottky	094

Diode Rectifiers

Small Signal Switching Diodes	097
General Purpose Rectifiers	099
Fast Recovery Rectifiers	102
Ultra Fast Recovery Rectifiers	104
Super Fast Recovery Rectifiers	107
Hyper Fast Recovery Rectifiers	112
FRED	113

Bridges

Bridge Rectifiers	114
Schottky Bridge Rectifiers	117
Fast Bridge Rectifiers	118

Protection Devices

Zener Diodes	119
ESD Protection	151
Transient Voltage Suppressors	159

Bipolar Junction Transistors

General Transistors	175
Low VCE(sat) Transistors	178

Appendix

Outline Drawing and Minimum Pad Layout	179
Tape Reel Packaging Standards	200
Packing Specifications	208

Small Signal MOSFETs

Part Number	Ch.	Config.	V _{DS}	V _{GS}	I _D	ESD	R _{DS(on)} Max. (mΩ)				Ciss Typ.	V _{GS(th)} Max.	Q _g Typ. (nC)		Package
			V	±V	A		10V	4.5V	2.5V	1.8V	pF	V	10V	4.5V	
PJQ1908-AU	N	Single	50	20	0.5	Y	1450	1950	4000	6000	36	1	-	0.95	DFN1006-3L
PJE8428-AU*	N	Single	30	10	0.3	Y	-	1200	1600	2000	45	1	-	0.9	SOT-523
PJE138K-AU	N	Single	50	20	0.35	Y	1600	2500	4500	-	25	1.5	-	0.63	
PJX8828-AU*	N/N	Dual	30	10	0.3	Y	-	1200	1600	2000	45	1	-	0.9	SOT-563
PJX138K-AU	N/N	Dual	50	20	0.35	Y	1600	2500	4500	-	25	1.5	-	0.63	
PJX8601-AU	N	Comple.	20	10	0.5	Y	-	400	650	800	38	0.9	-	1.4	
	P		-20	10	-0.5	Y	-	1200	1500	2200	67	-1	-	1.4	
PJX8603-AU	N	Comple.	50	20	0.36	Y	1500	2500	-	-	36	1	-	0.95	
	P		-60	20	-0.2	Y	6000	7000	-	-	51	-2.5	-	1.1	
PJC7428-AU*	N	Single	30	10	0.3	Y	-	1200	1600	2000	45	1	-	0.9	SOT-323
PJC138K-AU	N	Single	50	20	0.36	Y	1600	2500	4500	-	25	1.5	-	0.63	
PJC7438-AU	N	Single	50	20	0.4	Y	1450	1950	4000	6000	36	1	-	0.95	
2N7002KW-AU	N	Single	60	20	0.1	Y	3000	4000	-	-	35	2.5	-	0.8	
PJC7476-AU	N	Single	100	20	0.3	Y	6000	9000	-	-	45	2.5	1.8	-	
PJC7439-AU	P	Single	-60	20	-0.25	-	4000	6000	13000	-	51	-2.5	-	1.1	
PJT7828-AU*	N/N	Dual	30	10	0.3	Y	-	1200	1600	2000	45	1	-	0.9	SOT-363
PJT138K-AU	N/N	Dual	50	20	0.36	Y	1600	2500	4500	-	25	1.5	-	0.63	
2N7002KDW-AU	N/N	Dual	60	20	0.1	Y	3000	4000	-	-	35	2.5	-	0.8	
PJT7839-AU	P/P	Dual	-60	20	-0.25	-	4000	6000	-	-	51	-2.5	-	1.1	
PJT7604-AU*	N	Comple.	30	10	0.3	Y	-	1200	1600	2000	45	1	-	0.9	
	P		-30	10	-0.25	Y	-	2500	3000	4000	48	-1	-	0.92	
PJT7605-AU	N	Comple.	60	20	0.25	Y	3000	4000	13000	-	23	2.5	-	0.7	
	P		-60	20	-0.25	Y	4000	6000	13000	-	51	-2	-	1.1	
PJA3428-AU*	N	Single	30	10	0.3	Y	-	1200	1600	2000	45	1	-	0.9	SOT-23
PJA138K-AU	N	Single	50	20	0.5	Y	1600	2500	4500	-	25	1.5	-	0.63	
PJA3438-AU	N	Single	50	20	0.5	Y	1450	1950	4000	6000	36	1	-	0.95	
2N7002K-AU	N	Single	60	20	0.3	Y	3000	4000	-	-	35	2.5	-	0.8	
PJA3472B-AU	N	Single	60	30	0.3	-	3000	4000	-	-	34	2.5	-	0.82	
PJA3476-AU	N	Single	100	20	0.3	Y	6000	9000	-	-	45	2.5	1.8	-	
PJA3439-AU	P	Single	-60	20	-0.3	-	4000	6000	-	-	51	-2.5	-	1.1	
BSS84E-AU*	P	Single	-60	20	-0.3	Y	6000	7000	-	-	51	-2	-	1.1	

* Under Development

Low Voltage MOSFETs

Part Number	Ch.	Config.	V _{DS}	V _{GS}	I _D	ESD	R _{DS(on)} Max. (mΩ)						Ciss Typ.	V _{GS(th)} Max.	Q _g Typ. (nC)		Package
			V	±V	A		10V	7V	4.5V	2.5V	1.8V	1.5V	pF	V	10V	4.5V	
PJQ4534P-AU	N	Single	30	20	38	-	9.3	-	14.7	-	-	-	490	2.5	9.5	-	DFN3333-8L
PJQ4530P-AU	N	Single	30	20	49	-	7.8	-	13	-	-	-	600	2.5	12.4	-	
PJQ4528P-AU	N	Single	30	20	55	Y	6.5	-	10.5	-	-	-	785	2.5	10.7	-	
PJQ4526P-AU	N	Single	30	20	65	-	5.5	-	8.3	-	-	-	923	2.5	15	-	
PJQ4524P-AU	N	Single	30	20	80	-	4.4	-	6.5	-	-	-	1260	2.5	21	-	
PJQ4548VP-AU	N	Single	40	20	40	Y	10.4	-	-	-	-	-	673	3.5	9.5	-	
PJQ4548P-AU	N	Single	40	20	43	Y	9.1	-	12.5	-	-	-	778	2.3	13	-	
PJQ4442P-AU	N	Single	40	20	50	-	7.5	-	10.5	-	-	-	1759	2.5	-	17	
PJQ4546VP-AU	N	Single	40	20	61	-	6.3	-	7.7	-	-	-	1283	3.5	23	-	
PJQ4546P-AU	N	Single	40	20	64	-	5.6	-	7.9	-	-	-	1320	2.3	20	-	
PJQ4439EP-AU	P	Single	-30	25	-31	Y	19.1	-	31.2	-	-	-	1012	-2.5	22	-	
PJQ4437EP-AU	P	Single	-30	25	-41	Y	15.4	-	27	-	-	-	1270	-2.5	32	-	
PJQ4435EP-AU	P	Single	-30	25	-45	Y	12.5	-	20.3	-	-	-	1610	-2.5	34	-	
PJQ4433EP-AU	P	Single	-30	25	-68	Y	8.8	-	14	-	-	-	2310	-2.5	54	-	
PJQ4431EP-AU	P	Single	-30	25	-78	Y	7	-	11.1	-	-	-	3040	-2.5	68	-	
PJQ4453P-AU	P	Single	-40	20	-14	-	45	-	68	-	-	-	929	-2.5	-	8.3	
PJQ4441P-AU	P	Single	-40	20	-44	-	17	-	25	-	-	-	2030	-2.5	-	19	
PJQ4453EP-AU	P	Single	-40	25	-55	-	11.6	-	17.6	-	-	-	2858	-2.5	56	-	
PJQ4451EP-AU	P	Single	-40	25	-60	-	9.8	-	14.7	-	-	-	3300	-2.5	59	-	
PJQ4848P-AU	N/N	Dual	40	20	37	-	15	-	20	-	-	-	1040	2.5	-	10	DFN3333B-8L
PJQ5534-AU	N	Single	30	20	39	-	9.3	-	14.7	-	-	-	490	2.5	9.5	-	DFN5060-8L
PJQ5530-AU	N	Single	30	20	53	-	7.5	-	12.6	-	-	-	600	2.5	12.4	-	
PJQ5528-AU	N	Single	30	20	61	-	6	-	9.5	-	-	-	710	2.5	11	-	
PJQ5526-AU	N	Single	30	20	73	-	5	-	7.8	-	-	-	923	2.5	15	-	
PJQ5524-AU	N	Single	30	20	93	-	3.6	-	6.4	-	-	-	1260	2.5	21	-	
PJQ5522-AU	N	Single	30	20	141	-	2	-	3.1	-	-	-	2930	2.5	43	-	
PJQ5520-AU	N	Single	30	20	152	-	1.7	-	2.6	-	-	-	2936	2.5	45	-	
PJQ5450-AU	N	Single	40	20	21	-	32	-	40	-	-	-	425	2.5	-	4.4	
PJQ5548V-AU	N	Single	40	20	45	Y	10	12.4	-	-	-	-	673	3.5	9.5	-	
PJQ5548-AU	N	Single	40	20	48	Y	8.8	-	12.1	-	-	-	778	2.3	13	-	
PJQ5546V-AU	N	Single	40	20	79	-	5.9	7.3	-	-	-	-	1283	3.5	23	-	
PJQ5546-AU	N	Single	40	20	85	-	5.3	-	7.4	-	-	-	1320	2.3	20	-	
PJQ5544V-AU	N	Single	40	20	120	-	3.6	4.6	-	-	-	-	2544	3.5	34	-	
PJQ5544-AU	N	Single	40	20	130	-	3.3	-	4.3	-	-	-	2851	2.3	41	-	
PJQ5542V-AU	N	Single	40	20	136	-	3	3.6	-	-	-	-	3050	3.5	43	-	
PJQ5542-AU	N	Single	40	20	151	-	2.5	-	3.3	-	-	-	3125	2.3	50	-	
PJQ5439E-AU	P	Single	-30	25	-33	Y	18.8	-	30.7	-	-	-	1012	-2.5	22	-	
PJQ5437E-AU	P	Single	-30	25	-42	Y	15	-	26	-	-	-	1270	-2.5	32	-	
PJQ5435E-AU	P	Single	-30	25	-47	Y	12.1	-	20	-	-	-	1610	-2.5	34	-	
PJQ5433E-AU	P	Single	-30	25	-75	Y	8.4	-	13.5	-	-	-	2310	-2.5	54	-	
PJQ5431E-AU	P	Single	-30	25	-86	Y	6.4	-	10.4	-	-	-	3040	-2.5	68	-	
PJQ5445-AU	P	Single	-40	20	-45	-	17	-	25	-	-	-	2030	-2.5	-	19	
PJQ5453E-AU	P	Single	-40	25	-61	-	11.3	-	17.2	-	-	-	2858	-2.5	56	-	
PJQ5451E-AU	P	Single	-40	25	-67	-	9.4	-	14.3	-	-	-	3300	-2.5	59	-	
PJQ5449E-AU	P	Single	-40	25	-100	-	6	-	9.1	-	-	-	5790	-2.5	100	-	

Low Voltage MOSFETs

Part Number	Ch.	Config.	V _{DS}	V _{GS}	I _D	ESD	R _{DS(on)} Max. (mΩ)						Ciss Typ.	V _{GS(th)} Max.	Q _g Typ. (nC)		Package	
			V	±V	A		10V	7V	4.5V	2.5V	1.8V	1.5V	pF	V	10V	4.5V		
			PJQ5540V-AU	N	Single		40	20	174	-	2.1	2.7	-	-	-	-		4690
PJQ5540-AU	N	Single	40	20	192	-	1.88	-	2.5	-	-	-	4950	2.3	75	-		
PJQ5540VC-AU*	N	Single	40	20	258	-	1.38	1.84	-	-	-	-	4691	3.5	63	-		
PJQ5540C-AU*	N	Single	40	20	280	-	1.38	-	1.88	-	-	-	4973	2.3	75	-		
PJQ5518C-AU*	N	Single	30	20	310	-	1.1	-	1.45	-	-	-	4750	2.5	76	-		
PJQ5808-AU*	N/N	Dual	30	20	20	-	20	-	29	-	-	-	370	2.5	4.8	-	DFN5060B-8L	
PJQ5948V-AU	N/N	Dual	40	20	35	Y	13.4	17	-	-	-	-	673	3.5	9.5	-		
PJQ5948-AU	N/N	Dual	40	20	37	Y	12.3	-	15.7	-	-	-	778	2.3	13	-		
PJQ5948A-AU*	N/N	Dual	40	20	47	-	7.4	-	11.3	-	-	-	686	2.3	16	-		
PJQ5946V-AU*	N	Dual	40	20	57	-	7	8.4	-	-	-	-	1283	3.5	23	-		
PJQ5946-AU*	N	Dual	40	20	58	-	6.8	-	9.1	-	-	-	1328	2.3	20	-	SOT-523	
PJQ5839E-AU	P/P	Dual	-30	25	-31	Y	19.1	-	31.1	-	-	-	1012	-2.5	22	-		
PJE8402-AU	N	Single	20	8	0.7	Y	-	-	150	220	400	-	92	1	-	1.6		
PJE8408-AU	N	Single	20	10	0.5	Y	-	-	400	650	800	1200	67	0.9	-	1.4		
PJX8808-AU	N/N	Dual	20	10	0.5	Y	-	-	400	650	800	1200	67	0.9	-	1.4		
PJC7410-AU*	N	Single	20	10	0.5	Y	-	-	400	650	800	1200	67	0.9	-	1.4	SOT-323	
PJA3430-AU	N	Single	20	8	2	Y	-	-	150	215	400	-	92	1	-	1.8	SOT-23	
PJA3420E-AU*	N	Single	20	8	5.1	Y	-	-	28	35	47	-	515	1	-	6.3		
PJA3416AE-AU	N	Single	20	8	6.5	Y	-	-	22	26	34	-	836	1	-	8.6		
PJA3434-AU	N	Single	20	10	0.75	Y	-	-	400	650	800	1200	67	1	1.4	-		
PJA3436-AU	N	Single	20	12	1.2	Y	-	-	380	680	900	-	39	1	-	0.9		
PJA3412-AU	N	Single	20	12	4.1	-	-	-	56	68	95	-	350	1.2	-	4.6		
PJA3416-AU	N	Single	20	12	5.8	-	-	-	27	40	80	-	513	1.2	-	6.7		
PJA3432-AU	N	Single	30	8	1.6	Y	-	-	200	270	570	-	93	1.3	-	1.5		
PJA3402-AU	N	Single	30	12	4.4	-	48	-	53	66	92	-	447	1.2	11.3	-		
PJA3400-AU	N	Single	30	12	4.9	-	38	-	44	60	-	-	490	1.3	5.7	-		
PJA3406-AU	N	Single	30	20	4.4	-	48	-	70	-	-	-	235	2.1	5.8	-		
PJA3404-AU	N	Single	30	20	5.6	-	30	-	45	-	-	-	343	2.1	7.8	-		
PJA3446-AU	N	Single	40	20	4.1	-	42	-	51	-	-	-	425	2.5	-	4.4		
PJA3440-AU	N	Single	40	20	4.3	-	42	-	51	-	-	-	410	2.5	-	4.8		
PJA3419E-AU*	P	Single	-20	8	-3.7	Y	-	-	66	90	135	-	602	-1.2	-	6.9		
PJA3415AE-AU	P	Single	-20	8	-4.3	Y	-	-	50	58	73	-	907	-1	-	24		
PJA3411-AU	P	Single	-20	12	-3.1	-	-	-	100	135	190	-	416	-1.2	-	5.4		
PJA3413-AU	P	Single	-20	12	-3.4	-	-	-	82	110	146	-	522	-1.2	-	7		
PJA3415-AU	P	Single	-20	12	-4	-	-	-	62	75	95	-	756	-1.2	-	18		
PJA3419AE-AU	P	Single	-20	12	-4	Y	-	-	50	70	-	-	515	-1	7	-		
PJA3415A-AU	P	Single	-20	12	-4.5	-	-	-	46	56	88	-	980	-1.3	-	10		
PJA3433-AU	P	Single	-30	8	-1.1	Y	-	-	370	540	970	-	125	-1.3	-	1.6		
PJA3403-AU	P	Single	-30	12	-3.1	-	98	-	114	165	-	-	443	-1.3	11	-		
PJA3401-AU	P	Single	-30	12	-3.6	-	72	-	82	115	-	-	633	-1.3	15	-		
PJA3409-AU	P	Single	-30	20	-2.9	-	110	-	150	-	-	-	396	-2.1	9.8	-		
PJA3405-AU	P	Single	-30	20	-3.6	-	73	-	97	-	-	-	417	-2.1	10	-		
PJA3449-AU	P	Single	-40	20	-2.2	-	160	-	230	-	-	-	299	-2.1	7.3	-		
PJA3441-AU	P	Single	-40	20	-3.1	-	88	-	108	-	-	-	505	-2.5	-	6		
PJS6806-AU	N/N	Dual	30	20	4	-	48	-	70	-	-	-	235	2.1	5.8	-		SOT-23 6L
PJS6415A-AU	P	Single	-20	12	-5.2	-	-	-	46	56	88	-	980	-1.3	-	10		
PJS6403-AU	P	Single	-30	20	-6.4	-	37	-	43	59	-	-	870	-2.5	-	7.8		
PJS6809-AU	P/P	Dual	-30	20	-2.6	-	115	-	150	-	-	-	396	-2.1	9.8	-		
PJS6601-AU	N	Comple.	20	12	4.1	-	-	-	56	68	95	-	350	1.2	-	4.6		
	P		-20	12	-3.1	-	-	-	100	135	190	-	416	-1.2	-	5.4		
PJS6602-AU	N	Comple.	20	12	5.2	-	-	-	36	52	92	-	396	1.2	-	4.1		
	P		-20	12	-3.4	-	-	-	82	110	146	-	522	-1.2	-	7		
PJS6603-AU	N	Comple.	30	20	4.4	-	48	-	70	-	-	-	235	2.1	5.8	-		
	P		-30	20	-2.9	-	110	-	150	-	-	-	396	-2.1	9.8	-		

* Under Development

Low Voltage MOSFETs

Part Number	Ch.	Config.	V _{DS}	V _{GS}	I _D	ESD	R _{DS(on)} Max. (mΩ)						Ciss Typ.	V _{GS(th)} Max.	Q _g Typ. (nC)		Package
			V	±V	A		10V	7V	4.5V	2.5V	1.8V	1.5V	pF	V	10V	4.5V	
PJS6446-AU	N	Single	40	20	5.2	-	42	-	51	-	-	-	425	2.5	-	4.4	SOT-23 6L-1
PJS6421-AU	P	Single	-20	10	-7.4	-	-	-	26	32	40	-	1620	-1	-	16.5	
PJD25N04-AU	N	Single	40	20	21	-	32	-	40	-	-	-	425	2.5	-	4.4	
PJD25N04V-AU	N	Single	40	20	42	Y	11.3	14	-	-	-	-	681	3.5	9.5	-	TO-252AA
PJD30N04S-AU	N	Single	40	20	43	Y	10.6	-	14.6	-	-	-	744	2.3	13	-	
PJD50N04V-AU	N	Single	40	20	80	-	5.9	7.3	-	-	-	-	1287	3.5	23	-	
PJD55N04S-AU	N	Single	40	20	87	-	5.3	-	7.4	-	-	-	1328	2.3	20	-	
PJD55N04V-AU	N	Single	40	20	128	-	3.6	4.6	-	-	-	-	2540	3.5	34	-	
PJD60N04S-AU	N	Single	40	20	140	-	3.3	-	4.3	-	-	-	2862	2.3	41	-	
PJD60N04V-AU	N	Single	40	20	154	-	2.7	3.3	-	-	-	-	3054	3.5	43	-	
PJD65N04S-AU	N	Single	40	20	167	-	2.5	-	3.3	-	-	-	3148	2.3	50	-	
PJD75N04V-AU	N	Single	40	20	181	-	2.1	2.7	-	-	-	-	4691	3.5	63	-	
PJD80N04S-AU	N	Single	40	20	190	-	2.1	-	2.6	-	-	-	4973	2.3	75	-	
PJD40P03E-AU	P	Single	-30	25	-33	Y	18.8	-	30.7	-	-	-	1009	-2.5	22	-	
PJD45P03E-AU	P	Single	-30	25	-42	Y	15	-	26	-	-	-	1270	-2.5	32	-	
PJD55P03E-AU	P	Single	-30	25	-48	Y	12.1	-	20	-	-	-	1610	-2.5	34	-	
PJD70P03E-AU	P	Single	-30	25	-77	Y	8.4	-	13.5	-	-	-	2309	-2.5	54	-	
PJD90P03E-AU	P	Single	-30	25	-88	Y	6.4	-	10.4	-	-	-	3040	-2.5	68	-	
PJD16P04-AU	P	Single	-40	20	-16	-	45	-	68	-	-	-	929	-2.5	-	8.3	
PJD45P04-AU	P	Single	-40	20	-45	-	17	-	25	-	-	-	2030	-2.5	-	19	
PJD60P04E-AU	P	Single	-40	25	-61	-	11.3	-	17.2	-	-	-	2897	-2.5	56	-	
PJD75P04E-AU	P	Single	-40	25	-67	-	9.4	-	14.3	-	-	-	3477	-2.5	59	-	
PJD95P04E-AU	P	Single	-40	25	-108	-	6	-	9.1	-	-	-	5790	-2.5	100	-	
PJD100P04E-AU	P	Single	-40	25	-145	-	5.3	-	7.4	-	-	-	7169	-2.5	142	-	

Medium Voltage MOSFETs

Part Number	Ch.	Config.	V _{DS}	V _{GS}	I _D	ESD	R _{DS(on)} Max. (mΩ)			Ciss Typ.	V _{GS(th)} Max.	Q _g Typ. (nC)		Package	
			V	±V	A		10V	7V	4.5V	pF	V	10V	4.5V		
PJQ2460-AU	N	Single	60	20	3.2	-	75	-	90	509	2.5	9.3	-	DFN2020B-6L	
PJQ2463A-AU	P	Single	-60	20	-3.2	-	105	-	145	785	-2.5	10	-		
PJQ4460AP-AU	N	Single	60	20	11	-	72	-	88	509	2.5	9.3	-		
PJQ4468AP-AU	N	Single	60	20	18	-	34	-	40	1173	2.5	20	-	DFN3333-8L	
PJQ4466AP-AU	N	Single	60	20	33	-	21	-	24	1680	2.5	28	-		
PJQ4568AP-AU*	N	Single	60	20	36	-	14	-	25	800	3	16	-		
PJQ4564AP-AU*	N	Single	60	20	54	-	8.4	-	15	1453	3	27	-		
PJQ4576AP-AU	N	Single	100	20	35	-	17	-	26.5	1009	3	23	-		
PJQ4574AP-AU	N	Single	100	20	52	-	11.3	-	17	1459	3	35	-		
PJQ4594P-AU*	N	Single	150	20	18	-	50	55	-	1116	4	22	-		
PJQ4463AP-AU	P	Single	-60	20	-4.2	-	68	-	85	879	-2.5	17	-		
PJQ4465AP-AU	P	Single	-60	20	-15	-	48	-	65	1256	-2.5	22	-		
PJQ5458A-AU	N	Single	60	20	16	-	50	-	60	815	2.5	14	-		DFN5060-8L
PJQ5468A-AU	N	Single	60	20	25	-	34	-	40	1173	2.5	20	-		
PJQ5568A-AU*	N	Single	60	20	40	-	13.3	-	24.4	800	3	16	-		
PJQ5564A-AU*	N	Single	60	20	59	-	7.9	-	14.5	1453	3	27	-		
PJQ5562A-AU*	N	Single	60	20	89	-	5.9	-	9.5	2039	3	40	-		
PJQ5560A-AU*	N	Single	60	20	190	-	2.6	-	4.4	4728	3	82	-		
PJQ5576A-AU	N	Single	100	20	40	-	17	-	26	1009	3	23	-		
PJQ5574A-AU	N	Single	100	20	56	-	11	-	16	1459	3	35	-		
PJQ5572A-AU	N	Single	100	20	75	-	7.4	-	11	2658	3	62	-		
PJQ5594-AU*	N	Single	150	20	25	-	49	53	-	1116	4	22	-		
PJQ5592-AU*	N	Single	150	20	42	-	21	27	-	2118	4	36	-		
PJQ5590-AU*	N	Single	150	20	59	-	17	19	-	3043	4	53	-		
PJQ5465A-AU	P	Single	-60	20	-16	-	48	-	65	1256	-2.5	22	-		
PJQ5858A-AU	N/N	Dual	60	20	16	-	50	-	60	609	2.5	13	-	DFN5060B-8L	
PJQ5968A-AU*	N/N	Dual	60	20	36	-	14	-	25	800	3	16	-		
PJQ5863A-AU	P	Dual	-60	20	-13.6	-	68	-	85	879	-2.5	17	-		
PJW3P06A-AU	P	Single	-60	20	-3	-	170	-	220	430	-2.5	8.3	-	SOT-223	
PJW4P06A-AU	P	Single	-60	20	-4	-	110	-	130	785	-2.5	10	-		
PJW5P06A-AU	P	Single	-60	20	-5	-	68	-	85	879	-2.5	17	-		
PJW4N06A-AU	N	Single	60	20	4	-	100	-	110	509	2.5	-	5.1		
PJW5N06A-AU	N	Single	60	20	5	-	75	-	90	509	2.5	9.3	-		
PJW7N06A-AU	N	Single	60	20	6.6	-	34	-	40	1173	2.5	20	-		
PJW5N10-AU	N	Single	100	20	5	-	130	-	-	707	3.5	12	-		
PJA3461-AU	P	Single	-60	20	-1.9	-	170	-	240	430	-2.5	8.3	-	SOT-23	
PJA3460-AU	N	Single	60	20	2.5	-	75	-	90	509	2.5	9.3	-		
PJA3474S-AU	N	Single	100	20	2.5	-	118	-	160	155	3	4.4	-		
PJS6461-AU	P	Single	-60	20	-3.2	-	110	-	130	785	-2.5	10	-	SOT-23 6L	
PJD11N06A-AU	N	Single	60	20	11	-	75	-	90	509	2.5	9.3	-	TO-252AA	
PJD16N06A-AU	N	Single	60	20	16	-	50	-	60	815	2.5	14	-		
PJD25N06A-AU	N	Single	60	20	25	-	34	-	40	1173	2.5	20	-		
PJD45N06SA-AU*	N	Single	60	20	38	-	13.5	-	24	800	3	16	-		
PJD60N06SA-AU*	N	Single	60	20	66	-	7.9	-	14.5	1453	3	27	-		
PJD80N06SA-AU*	N	Single	60	20	94	-	5.9	-	9.6	2039	3	40	-		
PJD100N06SA-AU*	N	Single	60	20	168	-	3.3	-	5	4728	3	82	-		
PJD50N10SA-AU	N	Single	100	20	40	-	18	-	26	1009	3	23	-		
PJD65N10SA-AU	N	Single	100	20	59	-	12	-	17	1459	3	35	-		
PJD70N10SA-AU	N	Single	100	20	88	-	7.4	-	11	2658	3	62	-		
PJD30N15S-AU*	N	Single	150	20	26	-	49	54	-	1116	4	22	-		
PJD45N15S-AU*	N	Single	150	20	40	-	25	28	-	2118	4	36	-		
PJD50N15S-AU*	N	Single	150	20	65	-	16	19	-	3043	4	53	-		
PJD9P06A-AU	P	Single	-60	20	-7	-	170	-	220	430	-2.5	8.3	-		
PJD14P06A-AU	P	Single	-60	20	-14	-	110	-	130	785	-2.5	10	-		
PJD15P06A-AU	P	Single	-60	20	-15	-	68	-	85	879	-2.5	17	-		
PJD16P06A-AU	P	Single	-60	20	-16	-	48	-	65	1256	-2.5	22	-		
PJP75N06SA-AU*	N	Single	60	20	64	-	9	-	17	1454	3	27	-	TO-220AB-L	
PJP100N06SA-AU*	N	Single	60	20	95	-	6.1	-	10	2039	3	40	-		
PJP125N06SA-AU*	N	Single	60	20	215	-	2.6	-	4.4	4728	3	82	-		

* Under Development

SiC Diodes

Part Number	V_{RRM}	I_F	$V_F @ I_F$ Typ.		$I_R @ V_R$ Max.		P_D	Q_C	Package
	V	A	V	A	μA	V	W	nC	
PCDH2065CCG1-AU	650	20	1.5	10	70	650	98	24	TO-247AD-3LD
PCDH3065CCG1-AU	650	30	1.5	15	100	650	135.1	38	
PCDH4065CCG1-AU	650	40	1.5	20	120	650	176.5	46.7	
PCDH20120CCG1-AU	1200	20	1.5	10	100	1200	164.8	47.6	
PCDH30120CCG1-AU	1200	30	1.5	15	140	1200	230.8	72	
PCDH40120CCG1-AU	1200	40	1.5	20	180	1200	294.1	90	

Small Signal Schottky

Part Number	V_{RRM}	I_F	I_{FSM}	$V_F@I_F$		$I_R@V_R$		$C_J@V_R$		Package	
	V	A	A	V	mA	μA	V	pF	V		
SBA0520Q-AU	20	0.5	2	0.48	500	100	20	25	4	DFN 2L	
BAT54FN2-AU	30	0.2	0.6	1	100	2	25	-	-		
SBA0530Q-AU	30	0.5	2	0.52	500	100	30	20	4		
SBA0540Q-AU	40	0.5	2	0.6	500	50	40	15	4	SOD-923	
RB720M-30-AU	30	0.1	1	0.35	10	20	30	6	4	SOD-523	
BAT54TS-AU	30	0.2	0.6	0.6	100	2	30	4	4	SOD-523	
RB521S30-AU	30	0.2	1	0.5	200	100	30	8	4		
RB520S40-AU	40	0.25	1	0.6	200	5	30	30	0		
RB751S40-AU	40	0.3	0.5	0.37	1	0.5	30	2	1	SOD-323	
SBA0820CS-AU	20	0.8	2	0.55	800	100	20	25	4		
SD107WS-AU	30	0.2	0.75	0.8	100	1	25	-	-		
BAT54WS-AU	30	0.2	1	0.6	100	2	25	-	-		
BAT42WS-AU	30	0.2	4	1	200	0.5	30	-	-		
BAT43WS-AU	30	0.2	4	1	200	0.5	30	5	4		
RB551V-30-AU	30	0.5	5	0.49	500	100	30	-	-		
SBA0830CS-AU	30	0.8	2	0.6	800	100	30	20	4		
BAS40WS-AU	40	0.2	4	1	40	1	40	-	-		
RB751V-40-AU	40	0.3	0.6	0.37	1	0.5	30	3	1		
SD103AWS-AU	40	0.35	2	0.6	200	5	40	10	4		
SBA0840CS-AU	40	0.8	2	0.7	800	50	40	15	4		
RB501V-40-AU	45	0.1	1	0.55	100	100	45	8	4		
BAS70WS-AU	70	0.2	0.6	0.9	15	1	70	-	-		
BAS100CS-AU	100	0.5	5.5	0.85	500	1	100	21	4		
SBA0820AS-AU	20	0.8	2	0.55	800	100	20	25	4		SOD-123
BAT42W-AU	30	0.2	4	1	200	0.5	30	10	0		
SBA0830AS-AU	30	0.8	2	0.6	800	100	30	20	4		
SBA0840AS-AU	40	0.8	2	0.7	800	50	40	15	4		
BAS100AS-AU	100	0.5	5.5	0.85	500	1	100	21	4		

Small Signal Schottky

Part Number	V_{RRM}	I_F	I_{FSM}	$V_F@ I_F$		$I_R@V_R$		$C_J@V_R$		Package
	V	A	A	V	mA	μA	V	pF	V	
BAT54ATB-AU	30	0.2	0.6	1	100	2	25	10	0	SOT-523
BAT54CTB-AU	30	0.2	0.6	1	100	2	25	10	0	
BAT54STB-AU	30	0.2	0.6	1	100	2	25	10	0	
BAT54TB-AU	30	0.2	0.6	1	100	2	25	10	0	
BAT54TB6-AU	30	0.2	0.6	0.6	100	2	30	4	4	SOT-563
BAS40ADW-AU	40	0.2	0.6	1	40	1	25	-	-	SOT-363
BAS40CDW-AU	40	0.2	0.6	1	40	1	25	-	-	
BAS40SDW-AU	40	0.2	0.6	1	40	1	25	-	-	
BAS40TW-AU	40	0.2	0.6	1	40	1	25	-	-	
BAS70ADW-AU	70	0.2	0.6	0.9	15	0.1	50	-	-	
BAS70CDW-AU	70	0.2	0.6	0.9	15	0.1	50	-	-	
BAS70SDW-AU	70	0.2	0.6	0.9	15	0.1	50	-	-	
BAS70TW-AU	70	0.2	0.6	0.9	15	0.1	50	-	-	
BAT54AW-AU	30	0.2	0.6	0.6	100	2	25	10	1	SOT-323
BAT54CW-AU	30	0.2	0.6	0.6	100	2	25	10	1	
BAT54SW-AU	30	0.2	0.6	1	100	2	25	10	1	
BAT54W-AU	30	0.2	0.6	0.6	100	2	25	10	1	
BAS40AW-AU	40	0.2	0.6	1	40	1	25	-	-	
BAS40CW-AU	40	0.2	0.6	1	40	1	25	-	-	
BAS40SW-AU	40	0.2	0.6	1	40	1	25	-	-	
BAS40W-AU	40	0.2	0.6	1	40	1	25	-	-	
BAS70AW-AU	70	0.2	0.6	0.9	15	1	70	2	0	
BAS70CW-AU	70	0.2	0.6	0.9	15	1	70	2	0	
BAS70SW-AU	70	0.2	0.6	0.9	15	1	70	2	0	
BAS70W-AU	70	0.2	0.6	0.9	15	1	70	2	0	
SBA0520CA-AU	20	0.5	2	0.48	500	100	20	25	4	SOT-23
SBA0520SA-AU	20	0.5	2	0.48	500	100	20	15	4	
BAT54A-AU	30	0.2	0.6	0.6	100	2	25	10	1	
BAT54-AU	30	0.2	0.6	0.6	100	2	25	10	1	
BAT54C-AU	30	0.2	0.6	0.6	100	2	25	10	1	
BAT54S-AU	30	0.2	0.6	0.6	100	2	25	10	1	
SBA0530CA-AU	30	0.5	2	0.52	500	100	30	20	4	
SBA0530SA-AU	30	0.5	2	0.52	500	100	30	20	4	
BAS40A-AU	40	0.2	0.6	1	40	1	25	-	-	
BAS40-AU	40	0.2	0.6	1	40	1	25	-	-	
BAS40C-AU	40	0.2	0.6	1	40	1	25	-	-	
BAS40S-AU	40	0.2	0.6	1	40	1	25	-	-	
SBA0540CA-AU	40	0.5	2	0.6	500	50	40	15	4	
SBA0540SA-AU	40	0.5	2	0.6	500	50	40	25	4	
BAS70A-AU	70	0.2	0.6	1	15	1	70	-	-	
BAS70-AU	70	0.2	0.6	1	15	1	70	-	-	
BAS70C-AU	70	0.2	0.6	1	15	1	70	-	-	
BAS70S-AU	70	0.2	0.6	1	15	1	70	-	-	

Power Schottky

Part Number	V_{RRM}	I_F	I_{FSM}	$V_F@I_F$ Max.		$I_R@V_R$ Max.		Package
	V	A	A	V	A	μA	V	
MBR1040HEWS-AU	40	1	22	0.58	1	50	40	SOD-323HE
SS1030HEWS-AU	30	1	22	0.52	1	100	30	
SS1040HEWS-AU	40	1	22	0.58	1	100	40	
SS10150FL-AU	150	1	30	0.85	1	30	150	SOD-123FL
MB1H60AL-AU	60	1	30	0.75	1	3	60	
MB2H60AL-AU	60	2	50	0.75	2	3	60	
MBR1020VL-AU	20	1	45	0.34	1	600	20	
SS10100FL-AU	100	1	40	0.8	1	30	100	
SS1040FL-AU	40	1	40	0.55	1	30	40	
SS1060FL-AU	60	1	40	0.7	1	30	60	
SS1060XFL-AU	60	1	40	0.54	1	30	60	
SS20100FL-AU	100	2	50	0.85	2	40	100	
SS2060FL-AU	60	2	50	0.7	2	40	60	
SS2020FL-AU	20	2	50	0.5	2	100	20	
SS2030FL-AU	30	2	50	0.5	2	100	30	
SS2040FL-AU	40	2	50	0.5	2	100	40	
MB3H60AH-AU	60	3	80	0.7	3	5	60	
SS10100HE-AU	100	1	30	0.8	1	30	100	
SS10150HE-AU	150	1	30	0.85	1	30	150	
SS1040HE-AU	40	1	30	0.5	1	30	40	
SS1060HE-AU	60	1	30	0.7	1	30	60	
SS2060LHE-AU	60	2	50	0.68	2	100	60	
SS30100HE-AU	100	3	80	0.8	3	30	100	
SS3040HE-AU	40	3	80	0.52	3	160	40	
SS3060HE-AU	60	3	80	0.65	3	100	60	
SS1040-AU	40	1	30	0.55	1	60	40	SOD-123
MBR3H60AFC-AU	60	3	80	0.7	3	5	60	SMAF-C
MBR5H60AFC-AU	60	5	100	0.75	5	5	60	
SB36AFC-AU	60	3	80	0.75	3	100	60	
SB56AFC-AU	60	5	100	0.66	5	100	60	
SB25UAFC-AU	50	2	50	0.52	2	100	50	
SB33AFC-AU	30	3	80	0.5	3	100	30	
SB53AFC-AU	30	5	100	0.54	5	100	30	
SB54AFC-AU	40	5	100	0.54	5	100	40	
SB24AFC-AU	40	2	50	0.5	2	100	40	
SB34AFC-AU	40	3	80	0.5	3	100	40	
MBR310AFC-AU	100	3	80	0.8	3	50	100	SMA
SX3H15-AU	150	3	80	0.85	3	0.5	150	
BR210-AU	100	2	50	0.8	2	50	100	
BX34-AU	40	3	80	0.7	3	50	40	
MS110-AU	100	1	30	0.8	1	5	100	
SR24-AU	40	2	50	0.5	2	200	40	
SS14-AU	40	1	30	0.5	1	200	40	
SS16-AU	60	1	30	0.7	1	100	60	
SX34-AU	40	3	80	0.5	3	200	40	
SX36-AU	60	3	80	0.75	3	100	60	
BR310F-AU	100	3	80	0.8	3	50	100	SMBF
SR54F-AU	40	5	100	0.55	5	100	40	
SR56F-AU	60	5	100	0.7	5	100	60	

Power Schottky

Part Number	V_{RRM}	I_F	I_{FSM}	$V_F@I_F$ Max.		$I_R@V_R$ Max.		Package
	V	A	A	V	A	μA	V	
SR5H15-AU	150	5	150	0.85	5	0.5	150	SMB
BR310-AU	100	3	80	0.8	3	50	100	
BR36-AU	60	3	80	0.74	3	50	60	
MB24-AU	40	2	50	0.7	2	50	40	
S210L-AU	100	2	50	0.74	2	150	100	
SK23-AU	30	2	50	0.5	2	90	30	
SK24-AU	40	2	50	0.5	2	90	40	
SK24L-AU	40	2	50	0.45	2	250	40	
SK26-AU	60	2	50	0.7	2	90	60	
MB210-AU	100	2	50	0.8	2	50	100	
MB310-AU	100	3	80	0.8	3	50	100	
MB36-AU	60	3	80	0.74	3	50	60	
MB510-AU	100	5	100	0.8	5	50	100	
SK34-AU	40	3	100	0.5	3	200	40	
SK36-AU	60	3	100	0.75	3	100	60	
SK54-AU	40	5	100	0.55	5	200	40	TO-277C
MBR15H120PC-AU	120	15	210	0.87	15	1	120	
MBR5H150PC-AU	150	5	150	0.85	5	0.5	150	
MBR10H150PC-AU	150	10	250	0.85	10	0.55	150	
MBR5H60PC-AU	60	5	190	0.75	5	5	60	
MBR8H120PC-AU	120	8	160	0.87	8	1	120	
SB560LPC-AU	60	5	120	0.67	5	150	60	TO-263
MBR1060DC-AU	60	10	150	0.75	5	50	60	
MBR20100DC-AU	100	20	200	0.8	10	50	100	
MBR2040DC-AU	40	20	200	0.7	10	50	40	
MBR3040CT-AU	40	30	275	0.7	15	100	40	TO-220AB

Super Schottky

Part Number	V_{RRM}	I_F	I_{FSM}	$V_F@I_F$ Max.		$I_R@V_R$ Max.		Package
	V	A	A	V	A	μA	V	
SBA120CS-AU	20	1	8	0.45	1	100	20	SOD-323
SBA130CS-AU	30	1	8	0.47	1	100	30	
SBA140CS-AU	40	1	8	0.51	1	100	40	
SBA340AL-AU	40	3	50	0.48	3	150	40	SOD-123FL
SBM260VAL-AU	60	2	50	0.54	2	50	60	
SBA220AH-AU	20	2	30	0.46	2	100	20	SOD-123HE
SBA320AH-AU	20	3	50	0.44	3	200	20	
SBA230AH-AU	30	2	30	0.49	2	100	30	
SBA330AH-AU	30	3	50	0.46	3	200	30	
SBA240AH-AU	40	2	30	0.53	2	100	40	
SBA340AH-AU	40	3	50	0.48	3	150	40	
SSM3060VHE-AU	60	3	80	0.5	3	220	60	
SBA120AS-AU	20	1	10	0.45	1	100	20	SOD-123
SBA130AS-AU	30	1	10	0.47	1	100	30	
SBA140AS-AU	40	1	10	0.51	1	100	40	
SBM3060VDC-AU	60	15	250	0.59	15	220	60	TO-263
SBA320AFC-AU	20	3	50	0.44	3	200	20	SMAF-C
SBA330AFC-AU	30	3	50	0.46	3	200	30	
SBA340AFC-AU	40	3	50	0.48	3	150	40	
SBA540AFC-AU	40	5	80	0.49	5	250	40	
SBM34AVAF-AU	45	3	80	0.47	3	210	45	
SBM36VAFC-AU	60	3	80	0.5	3	220	60	
SRM54AV-AU	45	5	120	0.49	5	210	45	SMB

Small Signal Switching Diodes

Part Number	V_{RRM}	P_{TO}	T_{rr} Max.	$I_{FSM}@tp$		$V_F@I_F$ Max.		$I_R@V_R$ Max.		C_J Max.	Package	
	V	mW	ns	A	ms	V	mA	μA	V	pF		
1SS400-AU	100	175	4	4	0.001	1.2	100	0.1	80	1	SOD-523	
MMBD4148TS-AU	100	200	4	4	0.001	1.25	150	2.5	75	1.5		
BAS16TS-AU	100	200	6	4	0.001	0.855	10	1	75	2		
BAS116WS-AU	100	200	3000	4	0.001	1.25	150	0.005	75	2	SOD-323	
1N4148WS-AU	100	250	4	4	0.001	1.25	150	2.5	75	1.5		
BAS316-AU	100	400	4	4	0.001	1.25	150	0.5	100	1.5		
BAV19WS-AU	120	200	50	4	0.001	1	100	0.1	100	5		
BAV20WS-AU	200	200	50	4	0.001	1	100	0.1	150	5		
BAV21WS-AU	250	200	50	4	0.001	1	100	0.1	200	5		
1N4148W-AU	100	410	4	4	0.001	1.25	150	2.5	75	1.5		
1N4448W-AU	100	500	4	4	0.001	1	100	2.5	75	4	SOD-123	
BAV21W-AU	250	410	50	4	1	1	100	0.1	200	5	SOT-563	
BAV99STB6-AU	100	200	4	4	0.001	1.25	150	2.5	75	1.5		
BAS16TW-AU	100	200	4	4	0.001	1.25	150	2.5	100	1.5	SOT-363	
BAV70DW-AU	100	200	4	4	0.001	1.25	150	2.5	100	1.5		
BAV99S-AU	100	200	4	4	0.001	1.25	150	2.5	100	1.5		
BAW56DW-AU	100	200	4	4	0.001	1.25	150	2.5	100	1.5		
BAL99W-AU	100	200	4	4	0.001	1.25	150	2.5	75	1.5	SOT-323	
BAV70W-AU	100	200	4	4	0.001	1.25	150	2.5	75	1.5		
BAV99W-AU	100	200	4	4	0.001	1.25	150	2.5	75	1.5		
BAW56W-AU	100	200	4	4	0.001	1.25	150	2.5	75	1.5		
BAS16W-AU	100	200	6	4	0.001	0.855	10	1	75	2		
BAV199W-AU	100	200	3000	4	0.001	1.25	150	0.005	75	2		
BAS21W-AU	250	200	50	4	0.001	1	100	0.1	200	5		
BAL99-AU	100	250	4	4	0.001	1.25	150	2.5	75	1.5	SOT-23	
BAV70-AU	100	250	4	4	0.001	1.25	150	2.5	75	1.5		
BAV99-AU	100	250	4	4	0.001	1.25	150	2.5	75	1.5		
BAW56-AU	100	250	4	4	0.001	1.25	150	2.5	75	1.5		
MMBD4148-AU	100	250	4	4	0.001	1.25	150	2.5	75	1.5		
BAS116-AU	100	250	3000	4	0.001	1.25	150	0.005	75	2		
BAV170-AU	100	250	3000	4	0.001	1.25	150	0.005	75	2		
BAV199-AU	100	250	3000	4	0.001	1.25	150	0.005	75	2		
BAW156-AU	100	250	3000	4	0.001	1.25	150	0.005	75	2		
BAS16-AU	100	350	6	2	0.001	0.855	10	1	75	2		
BAS19-AU	120	350	50	2.5	0.001	1	100	0.1	100	1.5		
BAS20-AU	200	350	50	2.5	0.001	1	100	0.1	150	1.5		
BAS21A-AU	250	250	50	4	0.001	1	100	0.1	200	5		
BAS21C-AU	250	250	50	4	0.001	1	100	0.1	200	5		
BAS21S-AU	250	250	50	4	0.001	1	100	0.1	200	5		
BAS21-AU	250	350	50	2.5	0.001	1	100	0.1	200	1.5		
BAS21GW6-AU	250	500	50	4	0.001	1	100	0.1	200	5		SOT-23 6L

General Purpose Rectifiers

Part Number	V_{RRM}	I_F	I_{FSM}	$V_F@I_F$ Max.	@IF	$I_R@V_{RRM}$ Max.	Package
	V	A	A	V	A	μA	
GS1000FL-AU	50	1	30	1.1	1	1	SOD-123FL
GS1001FL-AU	100	1	30	1.1	1	1	
GS1002FL-AU	200	1	30	1.1	1	1	
GS1004FL-AU	400	1	30	1.1	1	1	
GS1504FL-AU	400	1.5	50	1.1	1.5	1	
GS1006FL-AU	600	1	30	1.1	1	1	
GS1506FL-AU	600	1.5	50	1.1	1.5	1	
GS1008FL-AU	800	1	30	1.1	1	1	
GS1508FL-AU	800	1.5	50	1.1	1.5	1	
GS1010FL-AU	1000	1	30	1.1	1	1	
GS1510FL-AU	1000	1.5	50	1.1	1.5	1	
GS2004HE-AU	400	2	50	1.1	2	1	SOD-123HE
GS1006HE-AU	600	1	30	1.1	1	1	
GS1GAFC-AU	400	1	30	1.1	1	1	SMAF-C
GS2GAFC-AU	400	2	70	1.1	2	1	
GS1JAFC-AU	600	1	30	1.1	1	1	
GS2JAFC-AU	600	2	70	1.1	1	1	
GS1KAFC-AU	800	1	30	1.1	1	1	
GS2KAFC-AU	800	2	70	1.1	1	1	
GS1MAFC-AU	1000	1	30	1.1	1	1	
GS2MAFC-AU	1000	2	70	1.1	1	1	
GS1A-AU	50	1	35	1.1	1	1	SMA
GS1B-AU	100	1	35	1.1	1	1	
GS1D-AU	200	1	35	1.1	1	1	
GH1D-AU	200	1	35	1.1	1	1	
GS1G-AU	400	1	35	1.1	1	1	
GH1G-AU	400	1	35	1.1	1	1	
GS1J-AU	600	1	35	1.1	1	1	
GS1K-AU	800	1	35	1.1	1	1	
GS1M-AU	1000	1	35	1.1	1	1	
S1GF-AU	400	1	30	1.1	1	1	
S2GF-AU	400	2	60	1.1	2	1	
S2GGF-AU	400	2	70	1.1	2	1	
S2JGF-AU	600	2	70	1.1	2	1	
S2KGF-AU	800	2	70	1.1	2	1	
S2MGF-AU	1000	2	70	1.1	2	1	
S2A-AU	50	2	60	1.1	2	1	SMB
S2B-AU	100	2	60	1.1	2	1	
S2D-AU	200	2	60	1.1	2	1	
S2G-AU	400	2	60	1.1	2	1	
S2J-AU	600	2	60	1.1	2	1	
S2K-AU	800	2	60	1.1	2	1	
S2M-AU	1000	2	60	1.1	2	1	

General Purpose Rectifiers

Part Number	V_{RRM}	I_F	I_{FSM}	$V_F@I_F$ Max.	@IF	$I_R@V_{RRM}$ Max.	Package
	V	A	A	V	A	μA	
S3A-AU	50	3	200	1.2	3	1	SMC
S5A-AU	50	5	275	1.1	5	10	
S3B-AU	100	3	200	1.2	3	1	
S5B-AU	100	5	275	1.1	5	10	
S3D-AU	200	3	200	1.2	3	1	
S5D-AU	200	5	275	1.1	5	10	
S3G-AU	400	3	200	1.2	3	1	
S5G-AU	400	5	275	1.1	5	10	
S3J-AU	600	3	200	1.2	3	1	
S5J-AU	600	5	275	1.1	5	10	
S3K-AU	800	3	200	1.2	3	1	
S8K-AU	800	8	400	0.985	8	10	
S10KC-AU	800	10	300	1.1	10	10	
S3M-AU	1000	3	200	1.2	3	1	
S5M-AU	1000	5	275	1.1	5	10	
S8M-AU	1000	8	400	0.985	8	10	
S10MC-AU	1000	10	300	1.1	10	10	
PG2010-AU	1000	2	70	1.1	2	1	
PG4001-AU	50	1	30	1.1	1	1	DO-41
PG4002-AU	100	1	30	1.1	1	1	
PG4003-AU	200	1	30	1.1	1	1	
PG4004-AU	400	1	30	1.1	1	1	
PG4005-AU	600	1	30	1.1	1	1	
PG4006-AU	800	1	30	1.1	1	1	
PG4007-AU	1000	1	30	1.1	1	1	

Hyper Fast Recovery Rectifiers

Part Number	V_{RRM}	I_F	Trr Max.	I_{FSM}	$V_F@I_F$ Max.		$I_R@V_R$ Max.		Package
	V	A	ns	A	V	A	μA	V	
MER2DAL-AU	200	2	35	60	0.95	2	1	200	SOD-123FL
MER2DAH-AU	200	2	35	60	0.95	2	1	200	SOD-123HE
MER3DAH-AU	200	3	35	75	0.95	3	1	200	
MER2DAFC-AU	200	2	35	60	0.95	2	1	200	SMAF-C
MER3DAFC-AU	200	3	35	75	0.95	3	1	200	
MER1DMA-AU	200	1	35	35	0.95	1	1	200	SMA
MER2DMA-AU	200	2	35	60	0.95	2	1	200	
MER3DMA-AU	200	3	35	75	0.95	3	1	200	SMBF
MER2DBF-AU	200	2	35	60	0.95	2	1	200	
MER3DBF-AU	200	3	35	75	0.95	3	1	200	SMB
MER1DMB-AU	200	1	35	35	0.95	1	1	200	
MER2DMB-AU	200	2	35	60	0.95	2	1	200	
MER3DMB-AU	200	3	35	75	0.95	3	1	200	

Schottky Bridge Rectifiers

Part Number	V_{RRM}	I_F	I_{FSM}	$V_F @ I_F$ Max.		$I_R @ V_R$ Max.		Package
	V	A	A	V	mA	μA	V	
TS240S-AU	40	2	50	0.5	2	50	40	MICRO DIP
TS360ILS-AU	60	3	60	0.66	3	65	60	

Zener Diodes

Part Number	P _D	V _Z	V _Z @ I _{ZT} (V)			Z _{VT} @ I _{ZT}	I _{ZT}	Z _{ZK} @ I _{ZK}	I _{ZK}	I _R @ V _R Max.		Package
	mW	%	Norm.	Min.	Max.	Ω	mA	Ω	mA	μA	V	
BZT52-B5V1FN2-AU	250	2	5.1	5	5.2	60	5	480	1	2	2	DFN 2L
BZX584B5V1-AU	200	2	5.1	5	5.2	60	5	480	1	2	2	
BZX584B5V6-AU	200	2	5.6	5.49	5.71	40	5	400	1	1	2	SOD-523
BZX584B8V2-AU	200	2	8.2	8.04	8.36	15	5	80	1	0.7	5	
BZX584C2V4-AU	200	5	2.4	2.28	2.52	100	5	600	1	50	1	
BZX584C2V7-AU	200	5	2.7	2.565	2.835	100	5	600	1	20	1	
BZX584C3-AU	200	5	3	2.85	3.15	95	5	600	1	10	1	
BZX584C3V3-AU	200	5	3.3	3.135	3.465	95	5	600	1	5	1	
BZX584C3V6-AU	200	5	3.6	3.42	3.78	90	5	600	1	5	1	
BZX584C3V9-AU	200	5	3.9	3.705	4.095	90	5	600	1	3	1	
BZX584C4V3-AU	200	5	4.3	4.085	4.515	90	5	600	1	3	1	
BZX584C4V7-AU	200	5	4.7	4.465	4.935	80	5	500	1	3	2	
BZX584C5V1-AU	200	5	5.1	4.845	5.355	60	5	480	1	2	2	
BZX584C5V6-AU	200	5	5.6	5.32	5.88	40	5	400	1	1	2	
BZX584C6V2-AU	200	5	6.2	5.89	6.51	10	5	150	1	3	4	
MMBZ5234BV-AU	200	5	6.2	5.89	6.51	7	20	1000	0.25	5	4	
BZX584C6V8-AU	200	5	6.8	6.46	7.14	15	5	80	1	2	4	
BZX584C7V5-AU	200	5	7.5	7.125	7.875	15	5	80	1	1	5	
BZX584C8V2-AU	200	5	8.2	7.79	8.61	15	5	80	1	0.7	5	
BZX584C8V7-AU	200	5	8.7	8.265	9.135	15	5	100	1	0.7	5	
BZX584C9V1-AU	200	5	9.1	8.645	9.555	15	5	100	1	0.5	6	
BZX584C10-AU	200	5	10	9.5	10.5	20	5	150	1	0.2	7	
BZX584C11-AU	200	5	11	10.45	11.55	20	5	150	1	0.1	8	
BZX584C12-AU	200	5	12	11.4	12.6	25	5	150	1	0.1	8	
BZX584C13-AU	200	5	13	12.35	13.65	30	5	170	1	0.1	8	
BZX584C14-AU	200	5	14	13.3	14.7	30	5	170	1	0.05	10	
BZX584C15-AU	200	5	15	14.25	15.75	30	5	200	1	0.05	10.5	
BZX584C16-AU	200	5	16	15.2	16.8	40	5	200	1	0.05	11.2	
BZX584C17-AU	200	5	17	16.15	17.85	40	5	200	1	0.05	12.2	
BZX584C18-AU	200	5	18	17.1	18.9	45	5	225	1	0.05	12.6	
BZX584C20-AU	200	5	20	19	21	55	5	225	1	0.05	14	
BZX584C22-AU	200	5	22	20.9	23.1	55	5	250	1	0.05	15.4	
BZX584C24-AU	200	5	24	22.8	25.2	70	5	250	1	0.05	16.8	
BZX584C27-AU	200	5	27	25.65	28.35	80	5	300	1	0.05	18.9	
BZX584C28-AU	200	5	28	26.6	29.4	80	5	300	1	0.05	20.5	
BZX584C30-AU	200	5	30	28.5	31.5	80	5	300	1	0.05	21	
BZX584C33-AU	200	5	33	31.35	34.65	80	5	325	1	0.05	23.1	
BZX584C36-AU	200	5	36	34.2	37.8	90	5	350	1	0.05	25.2	
BZX584C39-AU	200	5	39	37.05	40.95	130	5	350	1	0.05	27.3	
BZX584C43-AU	200	5	43	40.85	45.15	150	5	375	1	0.05	30.1	
BZX584C47-AU	200	5	47	44.65	49.35	170	5	375	1	0.05	32.9	
BZX584C51-AU	200	5	51	48.45	53.55	100	5	400	1	0.1	38	
BZX584C56-AU	200	5	56	53.2	58.8	135	2.5	1000	1	0.05	42	
BZX584C62-AU	200	5	62	58.9	65.1	150	2.5	1000	1	0.05	46	
BZX584C68-AU	200	5	68	64.6	71.4	200	2.5	1000	1	0.05	51	
BZX584C75-AU	200	5	75	71.25	78.75	250	2.5	1000	1	0.1	56	

Zener Diodes

Part Number	P _D	V _Z	V _Z @ I _{ZT} (V)			Z _{ZT} @ I _{ZT}	I _{ZT}	Z _{ZK} @ I _{ZK}	I _{ZK}	I _R @ V _R Max.		Package
	mW	%	Norm.	Min.	Max.	Ω	mA	Ω	mA	μA	V	
PZS513V9BCH-AU	500	5	3.9	3.71	4.1	-	0.05	-	-	5	2	SOD-323HE
PZS514V3BCH-AU	500	5	4.3	4.09	4.52	-	0.05	-	-	4	2	
PZS514V7BCH-AU	500	5	4.7	4.47	4.94	-	0.05	-	-	10	3	
PZS515V1BCH-AU	500	5	5.1	4.85	5.36	-	0.05	-	-	10	3	
PZS515V3BCH-AU	500	5	5.3	5.03	5.57	-	0.05	-	-	10	4	
PZS515V6BCH-AU	500	5	5.6	5.32	5.88	-	0.05	-	-	7	4.2	
PZS516V2BCH-AU	500	5	6.2	5.89	6.51	-	0.05	-	-	10	5	
PZS516V8BCH-AU	500	5	6.8	6.46	7.14	-	0.05	-	-	10	5.1	
PZS517V5BCH-AU	500	5	7.5	7.13	7.88	-	0.05	-	-	10	5.7	
PZS518V2BCH-AU	500	5	8.2	7.79	8.61	-	0.05	-	-	1	6.2	
PZS518V7BCH-AU	500	5	8.7	8.27	9.14	-	0.05	-	-	1	6.6	
PZS519V1BCH-AU	500	5	9.1	8.65	9.56	-	0.05	-	-	1	6.9	
PZS5110BCH-AU	500	5	10	9.5	10.5	-	0.05	-	-	1	7.6	
PZS5111BCH-AU	500	5	11	10.5	11.6	-	0.05	-	-	0.05	8.4	
PZS5112BCH-AU	500	5	12	11.4	12.6	-	0.05	-	-	0.05	9.1	
PZS5113BCH-AU	500	5	13	12.4	13.7	-	0.05	-	-	0.05	9.8	
PZS5114BCH-AU	500	5	14	13.3	14.7	-	0.05	-	-	0.05	10.6	
PZS5115BCH-AU	500	5	15	14.3	15.8	-	0.05	-	-	0.05	11.4	
PZS5116BCH-AU	500	5	16	15.2	16.8	-	0.05	-	-	0.05	12.1	
PZS5117BCH-AU	500	5	17	16.2	17.9	-	0.05	-	-	0.05	12.9	
PZS5118BCH-AU	500	5	18	17.1	18.9	-	0.05	-	-	0.05	13.6	
PZS5119BCH-AU	500	5	19	18.1	20	-	0.05	-	-	0.05	14.4	
PZS5120BCH-AU	500	5	20	19	21	-	0.05	-	-	0.01	15.2	
PZS5122BCH-AU	500	5	22	20.9	23.1	-	0.05	-	-	0.01	16.7	
PZS5124BCH-AU	500	5	24	22.8	25.2	-	0.05	-	-	0.01	18.2	
PZS5125BCH-AU	500	5	25	23.8	26.3	-	0.05	-	-	0.01	19	
PZS5127BCH-AU	500	5	27	25.7	28.4	-	0.05	-	-	0.01	20.4	
PZS5128BCH-AU	500	5	28	26.6	29.4	-	0.05	-	-	0.01	21.2	
PZS5130BCH-AU	500	5	30	28.5	31.5	-	0.05	-	-	0.01	22.8	
PZS5133BCH-AU	500	5	33	31.4	34.7	-	0.05	-	-	0.01	25	
PZS5136BCH-AU	500	5	36	34.2	37.8	-	0.05	-	-	0.01	27.3	
PZS5139BCH-AU	500	5	39	37.1	41	-	0.05	-	-	0.01	29.6	
PZS5143BCH-AU	500	5	43	40.9	45.2	-	0.05	-	-	0.01	32.6	

Zener Diodes

Part Number	P _D	V _Z	V _Z @ I _{ZT} (V)			Z _{VT} @ I _{ZT}	I _{ZT}	Z _{ZK} @ I _{ZK}	I _{ZK}	I _R @ V _R Max.		Package
	mW	%	Norm.	Min.	Max.	Ω	mA	Ω	mA	μA	V	
BZT52-B2V4S-AU	200	2	2.4	2.352	2.448	85	5	600	1	100	1	SOD-323
BZT52-B2V7S-AU	200	2	2.7	2.64	2.754	83	5	600	1	75	1	
BZT52-B3S-AU	200	2	3	2.94	3.06	95	5	600	1	50	1	
BZT52-B3V3S-AU	200	2	3.3	3.234	3.366	95	5	600	1	25	1	
BZT52-B3V6S-AU	200	2	3.6	3.52	3.672	95	5	600	1	15	1	
BZT52-B3V9S-AU	200	2	3.9	3.822	3.978	95	5	600	1	10	1	
BZT52-B4V3S-AU	200	2	4.3	4.21	4.39	95	5	600	1	5	1	
MMSZ5229AS-AU	200	2	4.3	4.21	4.39	22	20	2000	0.25	5	1	
BZT52-B4V7S-AU	200	2	4.7	4.61	4.79	78	5	500	1	5	1	
MMSZ5230AS-AU	200	2	4.7	4.61	4.79	19	20	1900	0.25	5	2	
BZT52-B5V1S-AU	200	2	5.1	5	5.2	60	5	480	1	0.1	0.8	
MMSZ5231AS-AU	200	2	5.1	5	5.2	17	20	1600	0.25	5	2	
BZT52-B5V6S-AU	200	2	5.6	5.49	5.71	40	5	400	1	0.1	1	
MMSZ5232AS-AU	200	2	5.6	5.49	5.71	11	20	1600	0.25	5	3	
BZT52-B5V8S-AU	200	2	5.8	5.68	5.92	30	5	300	1	0.1	1.5	
BZT52-B6V2S-AU	200	2	6.2	6.08	6.32	10	5	150	1	0.1	2	
MMSZ5234AS-AU	200	2	6.2	6.08	6.32	7	20	1000	0.25	5	4	
BZT52-B6V8S-AU	200	2	6.8	6.66	6.94	8	5	80	1	0.1	3	
MMSZ5235AS-AU	200	2	6.8	6.66	6.94	5	20	750	0.25	3	5	
BZT52-B7V5S-AU	200	2	7.5	7.35	7.65	7	5	80	1	0.1	5	
MMSZ5236AS-AU	200	2	7.5	7.35	7.65	6	20	500	0.25	3	6	
BZT52-B8V2S-AU	200	2	8.2	8.04	8.36	7	5	80	1	0.1	6	
MMSZ5237AS-AU	200	2	8.2	8.04	8.36	8	20	500	0.25	3	6	
BZT52-B8V7S-AU	200	2	8.7	8.53	8.87	7	5	100	1	0.1	6.5	
MMSZ5238AS-AU	200	2	8.7	8.53	8.87	8	20	600	0.25	3	6.5	
BZT52-B9V1S-AU	200	2	9.1	8.92	9.28	10	5	100	1	0.1	7	
MMSZ5239AS-AU	200	2	9.1	8.92	9.28	10	20	600	0.25	3	6.5	
BZT52-B10S-AU	200	2	10	9.8	10.2	15	5	150	1	0.1	7.5	
MMSZ5240AS-AU	200	2	10	9.8	10.2	17	20	600	0.25	3	8	
BZT52-B11S-AU	200	2	11	10.78	11.22	20	5	150	1	0.1	8.5	

Zener Diodes

Part Number	P _D	V _Z	V _Z @ I _{ZT}			Z _{ZT} @	I _{ZT}	Z _{ZK} @	I _{ZK}	I _R @ V _R		Package
	mW	%	Norm.	Min.	Max.	Ω	mA	Ω	mA	μA	V	
MMSZ5241AS-AU	200	2	11	10.78	11.22	22	20	600	0.25	2	8.4	SOD-323
BZT52-B12S-AU	200	2	12	11.76	12.24	20	5	150	1	0.1	9	
MMSZ5242AS-AU	200	2	12	11.76	12.24	30	20	600	0.25	1	9.1	
BZT52-B13S-AU	200	2	13	12.74	13.26	25	5	170	1	0.1	10	
MMSZ5243AS-AU	200	2	13	12.74	13.26	13	9.5	600	0.25	0.5	9.9	
BZT52-B14S-AU	200	2	14	13.72	14.28	25	5	170	1	0.1	10.5	
MMSZ5244AS-AU	200	2	14	13.72	14.28	15	9	600	0.25	0.1	10.5	
BZT52-B15S-AU	200	2	15	14.7	15.3	30	5	200	1	0.1	11	
MMSZ5245AS-AU	200	2	15	14.7	15.3	16	8.5	600	0.25	0.1	11	
BZT52-B16S-AU	200	2	16	15.68	16.32	40	5	200	1	0.1	12	
MMSZ5246AS-AU	200	2	16	15.68	16.32	17	7.8	600	0.25	0.1	12	
BZT52-B17S-AU	200	2	17	16.66	17.34	40	5	200	1	0.1	13	
MMSZ5247AS-AU	200	2	17	16.66	17.34	19	7.5	600	0.25	0.1	13	
BZT52-B18S-AU	200	2	18	17.64	18.36	50	5	225	1	0.1	14	
MMSZ5248AS-AU	200	2	18	17.64	18.36	21	7	600	0.25	0.1	14	
BZT52-B20S-AU	200	2	20	19.6	20.4	50	5	225	1	0.1	15	
MMSZ5250AS-AU	200	2	20	19.6	20.4	25	6.2	600	0.25	0.1	15	
BZT52-B22S-AU	200	2	22	21.56	22.44	55	5	250	1	0.1	17	
MMSZ5251AS-AU	200	2	22	21.56	22.44	29	5.6	600	0.25	0.1	17	
BZT52-B24S-AU	200	2	24	23.52	24.48	80	5	250	1	0.1	18	
MMSZ5252AS-AU	200	2	24	23.52	24.48	33	5.2	600	0.25	0.1	18	
BZT52-B27S-AU	200	2	27	26.46	27.54	80	5	300	1	0.1	20	
MMSZ5254AS-AU	200	2	27	26.46	27.54	41	5	600	0.25	0.1	21	
BZT52-B28S-AU	200	2	28	27.44	28.56	80	5	300	1	0.1	22	
MMSZ5255AS-AU	200	2	28	27.44	28.56	44	4.5	600	0.25	0.1	21	
BZT52-B30S-AU	200	2	30	29.4	30.6	80	5	300	1	0.1	22.5	
MMSZ5256AS-AU	200	2	30	29.4	30.6	49	4.2	600	0.25	0.1	23	
BZT52-B33S-AU	200	2	33	32.34	33.66	80	5	325	1	0.1	25	
MMSZ5257AS-AU	200	2	33	32.34	33.66	58	3.8	700	0.25	0.1	25	
BZT52-B36S-AU	200	2	36	35.28	36.72	90	5	350	1	0.1	27	
MMSZ5258AS-AU	200	2	36	35.28	36.72	70	3.4	700	0.25	0.1	27	
BZT52-B39S-AU	200	2	39	38.22	39.78	90	5	350	1	0.1	29	
MMSZ5259AS-AU	200	2	39	38.22	39.78	80	3.2	800	0.25	0.1	30	
BZT52-B43S-AU	200	2	43	42.14	43.86	100	5	375	1	0.1	32	
MMSZ5260AS-AU	200	2	43	42.14	43.86	93	3	900	0.25	0.1	33	
BZT52-B47S-AU	200	2	47	46.06	47.94	100	5	375	1	0.1	35	
MMSZ5261AS-AU	200	2	47	46.06	47.94	105	2.7	1000	0.25	0.1	36	
BZT52-B51S-AU	200	2	51	49.98	52.02	100	5	400	1	0.1	38	
MMSZ5262AS-AU	200	2	51	49.98	52.02	125	2.5	1100	0.25	0.1	39	
BZT52-B56S-AU	200	2	56	54.88	57.12	135	2.5	1000	1	0.1	42	
BZT52-B62S-AU	200	2	62	60.76	63.24	150	2.5	1000	1	0.1	46	
BZT52-B68S-AU	200	2	68	66.64	69.36	200	2.5	1000	1	0.1	51	
BZT52-B75S-AU	200	2	75	73.5	76.5	250	2.5	1000	1	0.1	56	
BZT52-C2V4S-AU	200	5	2.4	2.28	2.52	85	5	600	1	100	1	
MMSZ5221BS-AU	200	5	2.4	2.28	2.52	30	20	1200	0.25	100	1	
MMSZ5222BS-AU	200	5	2.5	2.38	2.63	30	20	1250	0.25	100	1	
BZT52-C2V7S-AU	200	5	2.7	2.57	2.84	83	5	600	1	75	1	
MMSZ5223BS-AU	200	5	2.7	2.57	2.84	30	20	1300	0.25	75	1	
BZT52-C3S-AU	200	5	3	2.85	3.15	95	5	600	1	50	1	
MMSZ5225BS-AU	200	5	3	2.85	3.15	30	20	1600	0.25	50	1	
BZT52-C3V3S-AU	200	5	3.3	3.14	3.47	95	5	600	1	25	1	
MMSZ5226BS-AU	200	5	3.3	3.14	3.47	28	20	1600	0.25	25	1	
BZT52-C3V6S-AU	200	5	3.6	3.42	3.78	95	5	600	1	15	1	
MMSZ5227BS-AU	200	5	3.6	3.42	3.78	24	20	1700	0.25	15	1	
BZT52-C3V9S-AU	200	5	3.9	3.71	4.1	95	5	600	1	10	1	
MMSZ5228BS-AU	200	5	3.9	3.71	4.1	23	20	1900	0.25	10	1	
BZT52-C4V3S-AU	200	5	4.3	4.09	4.52	95	5	600	1	5	1	
MMSZ5229BS-AU	200	5	4.3	4.09	4.52	22	20	2000	0.25	5	1	
BZT52-C4V7S-AU	200	5	4.7	4.47	4.94	78	5	500	1	5	1	
MMSZ5230BS-AU	200	5	4.7	4.47	4.94	19	20	1900	0.25	5	2	
BZT52-C5V1S-AU	200	5	5.1	4.85	5.36	60	5	480	1	0.1	0.8	
MMSZ5231BS-AU	200	5	5.1	4.85	5.36	17	20	1600	0.25	5	2	

Zener Diodes

Part Number	P _D	V _Z	V _Z @ I _{ZT}			Z _{VT} @	I _{ZT}	Z _{ZK} @	I _{ZK}	I _R @ V _R		Package
	mW	%	Norm.	Min.	Max.	Ω	mA	Ω	mA	μA	V	
BZT52-C5V6S-AU	200	5	5.6	5.32	5.88	40	5	400	1	0.1	1	SOD-323
MMSZ5232BS-AU	200	5	5.6	5.32	5.88	11	20	1600	0.25	5	3	
BZT52-C6V2S-AU	200	5	6.2	5.89	6.51	10	5	150	1	0.1	2	
MMSZ5234BS-AU	200	5	6.2	5.89	6.51	7	20	1000	0.25	5	4	
MMSZ4691WS-AU	200	5	6.2	5.89	6.61	-	0.05	-	-	10	5	
MMSZ4692WS-AU	200	5	6.8	6.46	7.14	-	0.05	-	-	10	5.1	
BZT52-C6V8S-AU	200	5	6.8	6.46	7.14	8	5	80	1	0.1	3	
MMSZ5235BS-AU	200	5	6.8	6.46	7.14	5	20	750	0.25	3	5	
BZT52-C7V5S-AU	200	5	7.5	7.13	7.88	7	5	80	1	0.1	5	
MMSZ5236BS-AU	200	5	7.5	7.13	7.88	6	20	500	0.25	3	6	
BZT52-C8V2S-AU	200	5	8.2	7.79	8.61	7	5	80	1	0.1	6	
MMSZ5237BS-AU	200	5	8.2	7.79	8.61	8	20	500	0.25	3	6	
BZT52-C8V7S-AU	200	5	8.7	8.27	9.14	7	5	100	1	0.1	6.5	
MMSZ5238BS-AU	200	5	8.7	8.27	9.14	8	20	600	0.25	3	6.5	
BZT52-C9V1S-AU	200	5	9.1	8.65	9.56	10	5	100	1	0.1	7	
MMSZ5239BS-AU	200	5	9.1	8.65	9.56	10	20	600	0.25	3	6.5	
BZT52-C10S-AU	200	5	10	9.5	10.5	15	5	150	1	0.1	7.5	
MMSZ5240BS-AU	200	5	10	9.5	10.5	17	20	600	0.25	3	8	
BZT52-C11S-AU	200	5	11	10.45	11.55	20	5	150	1	0.1	8.5	
MMSZ5241BS-AU	200	5	11	10.45	11.55	22	20	600	0.25	2	8.4	
BZT52-C12S-AU	200	5	12	11.4	12.6	20	5	150	1	0.1	9	
MMSZ5242BS-AU	200	5	12	11.4	12.6	30	20	600	0.25	1	9.1	
BZT52-C13S-AU	200	5	13	12.35	13.65	25	5	170	1	0.1	10	
MMSZ5243BS-AU	200	5	13	12.35	13.65	13	9.5	600	0.25	0.5	9.9	
BZT52-C14S-AU	200	5	14	13.3	14.7	25	5	170	1	0.1	10.5	
MMSZ5244BS-AU	200	5	14	13.3	14.7	15	9	600	0.25	0.1	10.5	
MMSZ4702WS-AU	200	5	15	14.25	15.75	-	0.05	-	-	0.05	11.4	
BZT52-C15S-AU	200	5	15	14.25	15.75	30	5	200	1	0.1	11	
MMSZ5245BS-AU	200	5	15	14.25	15.75	16	8.5	600	0.25	0.1	11	
BZT52-C16S-AU	200	5	16	15.2	16.8	40	5	200	1	0.1	12	
MMSZ5246BS-AU	200	5	16	15.2	16.8	17	7.8	600	0.25	0.1	12	
BZT52-C17S-AU	200	5	17	16.15	17.85	40	5	200	1	0.1	13	
MMSZ5247BS-AU	200	5	17	16.15	17.85	19	7.5	600	0.25	0.1	13	
BZT52-C18S-AU	200	5	18	17.1	18.9	50	5	225	1	0.1	14	
MMSZ5248BS-AU	200	5	18	17.1	18.9	21	7	600	0.25	0.1	14	
BZT52-C20S-AU	200	5	20	19	21	50	5	225	1	0.1	15	
MMSZ5250BS-AU	200	5	20	19	21	25	6.2	600	0.25	0.1	15	
BZT52-C22S-AU	200	5	22	20.9	23.1	55	5	250	1	0.1	17	
MMSZ5251BS-AU	200	5	22	20.9	23.1	29	5.6	600	0.25	0.1	17	
BZT52-C24S-AU	200	5	24	22.8	25.2	80	5	250	1	0.1	18	
MMSZ5252BS-AU	200	5	24	22.8	25.2	33	5.2	600	0.25	0.1	18	
BZT52-C27S-AU	200	5	27	25.65	28.35	80	5	300	1	0.1	20	
MMSZ5254BS-AU	200	5	27	25.65	28.35	41	5	600	0.25	0.1	21	
BZT52-C28S-AU	200	5	28	26.6	29.4	80	5	300	1	0.1	22	
MMSZ5255BS-AU	200	5	28	26.6	29.4	44	4.5	600	0.25	0.1	21	
BZT52-C30S-AU	200	5	30	28.5	31.5	80	5	300	1	0.1	22.5	
MMSZ5256BS-AU	200	5	30	28.5	31.5	49	4.2	600	0.25	0.1	23	
BZT52-C33S-AU	200	5	33	31.35	34.65	80	5	325	1	0.1	25	
MMSZ5257BS-AU	200	5	33	31.35	34.65	58	3.8	700	0.25	0.1	25	
BZT52-C36S-AU	200	5	36	34.2	37.8	90	5	350	1	0.1	27	
MMSZ5258BS-AU	200	5	36	34.2	37.8	70	3.4	700	0.25	0.1	27	
BZT52-C39S-AU	200	5	39	37.05	40.95	90	5	350	1	0.1	29	
MMSZ5259BS-AU	200	5	39	37.05	40.95	80	3.2	800	0.25	0.1	30	
BZT52-C43S-AU	200	5	43	40.85	45.15	100	5	375	1	0.1	32	
MMSZ5260BS-AU	200	5	43	40.85	45.15	93	3	900	0.25	0.1	33	
BZT52-C47S-AU	200	5	47	44.65	49.35	100	5	375	1	0.1	35	
MMSZ5261BS-AU	200	5	47	44.65	49.35	105	2.7	1000	0.25	0.1	36	
BZT52-C51S-AU	200	5	51	48.45	53.55	100	5	400	1	0.1	38	
MMSZ5262BS-AU	200	5	51	48.45	53.55	125	2.5	1100	0.25	0.1	39	
BZT52-C56S-AU	200	5	56	53.2	58.8	135	2.5	1000	1	0.1	42	
BZT52-C62S-AU	200	5	62	58.9	65.1	150	2.5	1000	1	0.1	46	
BZT52-C68S-AU	200	5	68	64.6	71.4	200	2.5	1000	1	0.1	51	

Zener Diodes

Part Number	P _D	V _Z	V _Z @ I _{ZT} (V)			Z _{ZT} @ I _{ZT}	I _{ZT}	Z _{ZK} @ I _{ZK}	I _{ZK}	I _R @ V _R Max.		Package
	mW	%	Norm.	Min.	Max.	Ω	mA	Ω	mA	μA	V	
BZT52-C75S-AU	200	5	75	71.25	78.75	250	2.5	1000	1	0.1	56	SOD-323
PDZ4.7B-AU	400	2	4.7	4.55	4.75	90	5	600	1	0.75	1.5	
PDZ5.1B-AU	400	2	5.1	4.96	5.2	60	5	800	0.5	0.75	1.5	
PDZ5.6B-AU	400	2	5.6	5.48	5.73	50	5	400	0.5	0.5	3	
PDZ6.2B-AU	400	2	6.2	6.06	6.33	50	5	80	0.5	0.5	3	
PDZ6.8B-AU	400	2	6.8	6.65	6.93	40	5	60	0.5	0.5	3.5	
PDZ7.5B-AU	400	2	7.4	7.28	7.6	10	5	60	0.5	0.5	4	
PDZ8.2B-AU	400	2	8.2	8.02	8.36	10	5	60	0.5	0.5	5	
PDZ9.1B-AU	400	2	9	8.85	9.23	10	5	60	0.5	0.5	6	
PDZ10B-AU	400	2	10	9.77	10.21	10	5	60	0.5	0.1	7	
PDZ11B-AU	400	2	11	10.78	11.22	10	5	60	0.5	0.1	8	
PDZ12B-AU	400	2	12	11.74	12.24	10	5	80	0.5	0.1	9	
PDZ13B-AU	400	2	13.2	12.91	13.49	10	5	80	0.5	0.1	10	
PDZ15B-AU	400	2	14.7	14.34	14.98	15	5	80	0.5	0.05	11	
PDZ16B-AU	400	2	16.2	15.85	16.51	20	5	80	0.5	0.05	12	
PDZ18B-AU	400	2	18	17.56	18.35	20	5	80	0.5	0.05	13	
PDZ20B-AU	400	2	20	19.52	20.39	20	5	100	0.5	0.05	15	
PDZ22B-AU	400	2	22	21.54	22.47	25	5	100	0.5	0.05	17	
PDZ24B-AU	400	2	24.3	23.72	24.78	30	5	120	0.5	0.05	19	
PDZ27B-AU	400	2	26.9	26.19	27.53	40	5	150	0.5	0.05	21	
PDZ30B-AU	400	2	29.9	29.19	30.69	40	5	200	0.5	0.05	23	
PDZ33B-AU	400	2	33	32.15	33.79	40	5	250	0.5	0.05	25	
PDZ36B-AU	400	2	36	35.07	36.87	60	5	300	0.5	0.05	27	

Zener Diodes

Part Number	P _D mW	V _Z %	V _Z @ I _{ZT} (V)			Z _{ZT} @ I _{ZT}	I _{ZT} mA	Z _{ZK} @ I _{ZK}	I _{ZK} mA	I _R @ V _R Max.		Package
			Norm.	Min.	Max.	Ω		Ω		μA	V	
PZ1AL3V6B-AU	1000	5	3.6	3.42	3.78	8	100	400	1	100	1	SOD-123FL
PZ1AL3V9B-AU	1000	5	3.9	3.71	4.1	8	100	400	1	50	1	
PZ1AL4V3B-AU	1000	5	4.3	4.09	4.52	7	100	400	1	25	1	
PZ1AL4V7B-AU	1000	5	4.7	4.47	4.94	7	100	400	1	10	1	
PZ1AL5V1B-AU	1000	5	5.1	4.85	5.36	6	100	550	1	5	1	
PZ1AL5V6B-AU	1000	5	5.6	5.32	5.88	4	100	600	1	10	2	
PZ1AL6V0B-AU	1000	5	6	5.7	6.3	3	100	600	1	8	2	
PZ1AL6V2B-AU	1000	5	6.2	5.89	6.51	3	100	700	1	5	2	
PZ1AL6V8B-AU	1000	5	6.8	6.46	7.14	3	100	700	1	10	3	
PZ1AL7V5B-AU	1000	5	7.5	7.13	7.88	2	100	700	0.5	50	3	
PZ1AL8V2B-AU	1000	5	8.2	7.79	8.61	2	100	700	0.5	10	3	
PZ1AL8V7B-AU	1000	5	8.7	8.27	9.14	3	50	700	0.5	10	4	
PZ1AL9V1B-AU	1000	5	9.1	8.65	9.56	4	50	700	0.5	10	5	
PZ1AL10B-AU	1000	5	10	9.5	10.5	4	50	700	0.25	7	7.5	
PZ1AL11B-AU	1000	5	11	10.45	11.55	7	50	700	0.25	4	8.2	
PZ1AL12B-AU	1000	5	12	11.4	12.6	7	50	700	0.25	3	9.1	
PZ1AL13B-AU	1000	5	13	12.35	13.65	10	50	700	0.25	2	10	
PZ1AL14B-AU	1000	5	14	13.3	14.7	10	50	700	0.25	2	11	
PZ1AL15B-AU	1000	5	15	14.25	15.75	10	50	700	0.25	1	11	
PZ1AL16B-AU	1000	5	16	15.2	16.8	15	25	700	0.25	1	12	
PZ1AL17B-AU	1000	5	17	16.15	17.85	15	25	750	0.25	1	13	
PZ1AL18B-AU	1000	5	18	17.1	18.9	15	25	750	0.25	1	13	
PZ1AL19B-AU	1000	5	19	18.05	19.95	15	25	750	0.25	1	14	
PZ1AL20B-AU	1000	5	20	19	21	15	25	750	0.25	1	15	
PZ1AL22B-AU	1000	5	22	20.9	23.1	15	25	750	0.25	1	16	
PZ1AL24B-AU	1000	5	24	22.8	25.2	15	25	750	0.25	1	18	
PZ1AL25B-AU	1000	5	25	23.75	26.25	15	25	750	0.25	1	19	
PZ1AL27B-AU	1000	5	27	25.65	28.35	15	25	750	0.25	1	20	
PZ1AL28B-AU	1000	5	28	26.6	29.4	15	25	1000	0.25	1	21	
PZ1AL30B-AU	1000	5	30	28.5	31.5	15	25	1000	0.25	1	22	
PZ1AL33B-AU	1000	5	33	31.35	34.65	15	25	1000	0.25	1	24	
PZ1AL36B-AU	1000	5	36	34.2	37.8	40	10	1000	0.25	1	27	
PZ1AL39B-AU	1000	5	39	37.05	40.95	40	10	1000	0.25	1	30	
PZ1AL43B-AU	1000	5	43	40.85	45.15	45	10	1500	0.25	1	33	
PZ1AL47B-AU	1000	5	47	44.65	49.35	45	10	1500	0.25	1	36	
PZ1AL51B-AU	1000	5	51	48.45	53.55	60	10	1500	0.25	1	39	
PZ1AL56B-AU	1000	5	56	53.2	58.8	60	10	2000	0.25	1	43	
PZ1AL62B-AU	1000	5	62	58.9	65.1	80	10	2000	0.25	1	47	
PZ1AL68B-AU	1000	5	68	64.6	71.4	80	10	2000	0.25	1	51	
PZ1AL75B-AU	1000	5	75	71.25	78.75	100	10	2000	0.25	1	56	

Zener Diodes

Part Number	P _D mW	V _Z %	V _Z @ I _{ZT} (V)			Z _{ZT} @ I _{ZT}	I _{ZT} mA	Z _{ZK} @ I _{ZK}	I _{ZK} mA	I _R @ V _R Max.		Package
			Norm.	Min.	Max.	Ω		Ω		μA	V	
PZ1AH3V6B-AU	1000	5	3.6	3.42	3.78	8	100	400	1	100	1	SOD-123HE
PZ1AH3V9B-AU	1000	5	3.9	3.71	4.1	8	100	400	1	50	1	
PZ1AH4V3B-AU	1000	5	4.3	4.09	4.52	7	100	400	1	25	1	
PZ1AH4V7B-AU	1000	5	4.7	4.47	4.94	7	100	400	1	10	1	
PZ1AH5V1B-AU	1000	5	5.1	4.85	5.36	6	100	550	1	5	1	
PZ1AH5V6B-AU	1000	5	5.6	5.32	5.88	4	100	600	1	10	2	
PZ1AH6V0B-AU	1000	5	6	5.7	6.3	3	100	600	1	8	2	
PZ1AH6V2B-AU	1000	5	6.2	5.89	6.51	3	100	700	1	5	2	
PZ1AH6V8B-AU	1000	5	6.8	6.46	7.14	3	100	700	1	10	3	
PZ1AH7V5B-AU	1000	5	7.5	7.13	7.88	2	100	700	0.5	50	3	
PZ1AH8V2B-AU	1000	5	8.2	7.79	8.61	2	100	700	0.5	10	3	
PZ1AH8V7B-AU	1000	5	8.7	8.27	9.14	3	50	700	0.5	10	4	
PZ1AH9V1B-AU	1000	5	9.1	8.65	9.56	4	50	700	0.5	10	5	
PZ1AH10B-AU	1000	5	10	9.5	10.5	4	50	700	0.25	7	7.5	
PZ1AH11B-AU	1000	5	11	10.45	11.55	7	50	700	0.25	4	8.2	
PZ1AH12B-AU	1000	5	12	11.4	12.6	7	50	700	0.25	3	9.1	
PZ1AH13B-AU	1000	5	13	12.35	13.65	10	50	700	0.25	2	10	
PZ1AH14B-AU	1000	5	14	13.3	14.7	10	50	700	0.25	2	11	
PZ1AH15B-AU	1000	5	15	14.25	15.75	10	50	700	0.25	1	11	
PZ1AH16B-AU	1000	5	16	15.2	16.8	15	25	700	0.25	1	12	
PZ1AH17B-AU	1000	5	17	16.15	17.85	15	25	750	0.25	1	13	
PZ1AH18B-AU	1000	5	18	17.1	18.9	15	25	750	0.25	1	13	
PZ1AH19B-AU	1000	5	19	18.05	19.95	15	25	750	0.25	1	14	
PZ1AH20B-AU	1000	5	20	19	21	15	25	750	0.25	1	15	
PZ1AH22B-AU	1000	5	22	20.9	23.1	15	25	750	0.25	1	16	
PZ1AH24B-AU	1000	5	24	22.8	25.2	15	25	750	0.25	1	18	
PZ1AH25B-AU	1000	5	25	23.75	26.25	15	25	750	0.25	1	19	
PZ1AH27B-AU	1000	5	27	25.65	28.35	15	25	750	0.25	1	20	
PZ1AH28B-AU	1000	5	28	26.6	29.4	15	25	1000	0.25	1	21	
PZ1AH30B-AU	1000	5	30	28.5	31.5	15	25	1000	0.25	1	22	
PZ1AH33B-AU	1000	5	33	31.35	34.65	15	25	1000	0.25	1	24	
PZ1AH36B-AU	1000	5	36	34.2	37.8	40	10	1000	0.25	1	27	
PZ1AH39B-AU	1000	5	39	37.05	40.95	40	10	1000	0.25	1	30	
PZ1AH43B-AU	1000	5	43	40.85	45.15	45	10	1500	0.25	1	33	
PZ1AH47B-AU	1000	5	47	44.65	49.35	45	10	1500	0.25	1	36	
PZ1AH51B-AU	1000	5	51	48.45	53.55	60	10	1500	0.25	1	39	
PZ1AH56B-AU	1000	5	56	53.2	58.8	60	10	2000	0.25	1	43	
PZ1AH62B-AU	1000	5	62	58.9	65.1	80	10	2000	0.25	1	47	
PZ1AH68B-AU	1000	5	68	64.6	71.4	80	10	2000	0.25	1	51	
PZ1AH75B-AU	1000	5	75	71.25	78.75	100	10	2000	0.25	1	56	
BZT52-B2V4-AU	410	2	2.4	2.35	2.45	85	5	600	1	100	1	SOD-123
BZT52-B2V7-AU	410	2	2.7	2.64	2.75	83	5	600	1	75	1	
BZT52-B3-AU	410	2	3	2.94	3.06	95	5	600	1	50	1	
BZT52-B3V3-AU	410	2	3.3	3.23	3.37	95	5	600	1	25	1	
BZT52-B3V6-AU	410	2	3.6	3.52	3.67	95	5	600	1	15	1	
BZT52-B3V9-AU	410	2	3.9	3.82	3.98	95	5	600	1	10	1	
BZT52-B4V3-AU	410	2	4.3	4.21	4.39	95	5	600	1	5	1	
BZT52-B4V7-AU	410	2	4.7	4.61	4.79	78	5	500	1	5	1	
BZT52-B5V1-AU	410	2	5.1	5	5.2	60	5	480	1	0.1	0.8	
BZT52-B5V6-AU	410	2	5.6	5.49	5.71	40	5	400	1	0.1	1	
BZT52-B6V2-AU	410	2	6.2	6.08	6.32	10	5	150	1	0.1	2	
BZT52-B6V8-AU	410	2	6.8	6.66	6.94	8	5	80	1	0.1	3	
BZT52-B7V5-AU	410	2	7.5	7.35	7.65	7	5	80	1	0.1	5	
BZT52-B8V2-AU	410	2	8.2	8.04	8.36	7	5	80	1	0.1	6	
BZT52-B8V7-AU	410	2	8.7	8.53	8.87	7	5	100	1	0.1	6.5	
BZT52-B9V1-AU	410	2	9.1	8.92	9.28	10	5	100	1	0.1	7	
BZT52-B10-AU	410	2	10	9.8	10.2	15	5	150	1	0.1	7.5	

Zener Diodes

Part Number	P _D	V _Z	V _Z @ I _{ZT}			Z _{ZT} @	I _{ZT}	Z _{ZK} @	I _{ZK}	I _R @ V _R		Package
	mW	%	Norm.	Min.	Max.	Ω	mA	Ω	mA	μA	V	
BZT52-B11-AU	410	2	11	10.78	11.22	20	5	150	1	0.1	8.5	SOD-123
BZT52-B12-AU	410	2	12	11.76	12.24	20	5	150	1	0.1	9	
BZT52-B13-AU	410	2	13	12.74	13.26	25	5	170	1	0.1	10	
BZT52-B14-AU	410	2	14	13.72	14.28	25	5	170	1	0.1	10.5	
BZT52-B15-AU	410	2	15	14.7	15.3	30	5	200	1	0.1	11	
BZT52-B16-AU	410	2	16	15.68	16.32	40	5	200	1	0.1	12	
BZT52-B17-AU	410	2	17	16.66	17.34	40	5	200	1	0.1	13	
BZT52-B18-AU	410	2	18	17.64	18.36	50	5	225	1	0.1	14	
BZT52-B20-AU	410	2	20	19.6	20.4	50	5	225	1	0.1	15	
BZT52-B22-AU	410	2	22	21.56	22.44	55	5	250	1	0.1	17	
BZT52-B24-AU	410	2	24	23.52	24.48	80	5	250	1	0.1	18	
BZT52-B27-AU	410	2	27	26.46	27.54	80	5	300	1	0.1	20	
BZT52-B28-AU	410	2	28	27.44	28.56	80	5	300	1	0.1	22	
BZT52-B30-AU	410	2	30	29.4	30.6	80	5	300	1	0.1	22.5	
BZT52-B33-AU	410	2	33	32.34	33.66	80	5	325	1	0.1	25	
BZT52-B36-AU	410	2	36	35.28	36.72	90	5	350	1	0.1	27	
BZT52-B39-AU	410	2	39	38.22	39.78	90	5	350	1	0.1	29	
BZT52-B43-AU	410	2	43	42.14	43.86	100	5	375	1	0.1	32	
BZT52-B47-AU	410	2	47	46.06	47.94	100	5	375	1	0.1	35	
BZT52-B51-AU	410	2	51	49.98	52.02	100	5	400	1	0.1	38	
BZT52-B56-AU	410	2	56	54.88	57.12	135	2.5	1000	1	0.1	42	
BZT52-B62-AU	410	2	62	60.76	63.24	150	2.5	1000	1	0.1	46	
BZT52-B68-AU	410	2	68	66.64	69.36	200	2.5	1000	1	0.1	51	
BZT52-B75-AU	410	2	75	73.5	76.5	250	2.5	1000	1	0.1	56	
BZT52-C2V4-AU	410	5	2.4	2.28	2.52	85	5	600	1	100	1	
BZT52-C2V7-AU	410	5	2.7	2.57	2.84	83	5	600	1	75	1	
BZT52-C3-AU	410	5	3	2.85	3.15	95	5	600	1	50	1	
BZT52-C3V3-AU	410	5	3.3	3.14	3.47	95	5	600	1	25	1	
BZT52-C3V6-AU	410	5	3.6	3.42	3.78	95	5	600	1	15	1	
BZT52-C3V9-AU	410	5	3.9	3.71	4.1	95	5	600	1	10	1	
BZT52-C4V3-AU	410	5	4.3	4.09	4.52	95	5	600	1	5	1	
BZT52-C4V7-AU	410	5	4.7	4.47	4.94	78	5	500	1	5	1	
BZT52-C5V1-AU	410	5	5.1	4.85	5.36	60	5	480	1	0.1	0.8	
BZT52-C5V6-AU	410	5	5.6	5.32	5.88	40	5	400	1	0.1	1	
BZT52-C6V2-AU	410	5	6.2	5.89	6.51	10	5	150	1	0.1	2	
BZT52-C6V8-AU	410	5	6.8	6.46	7.14	8	5	80	1	0.1	3	
BZT52-C7V5-AU	410	5	7.5	7.13	7.88	7	5	80	1	0.1	5	
BZT52-C8V2-AU	410	5	8.2	7.79	8.61	7	5	80	1	0.1	6	
BZT52-C8V7-AU	410	5	8.7	8.27	9.14	7	5	100	1	0.1	6.5	
BZT52-C9V1-AU	410	5	9.1	8.65	9.56	10	5	100	1	0.1	7	
BZT52-C10-AU	410	5	10	9.5	10.5	15	5	150	1	0.1	7.5	
BZT52-C11-AU	410	5	11	10.45	11.55	20	5	150	1	0.1	8.5	
BZT52-C12-AU	410	5	12	11.4	12.6	20	5	150	1	0.1	9	
BZT52-C13-AU	410	5	13	12.35	13.65	25	5	170	1	0.1	10	
BZT52-C14-AU	410	5	14	13.3	14.7	25	5	170	1	0.1	10.5	
BZT52-C15-AU	410	5	15	14.25	15.75	30	5	200	1	0.1	11	
BZT52-C16-AU	410	5	16	15.2	16.8	40	5	200	1	0.1	12	
BZT52-C17-AU	410	5	17	16.15	17.85	40	5	200	1	0.1	13	
BZT52-C18-AU	410	5	18	17.1	18.9	50	5	225	1	0.1	14	
BZT52-C20-AU	410	5	20	19	21	50	5	225	1	0.1	15	
BZT52-C22-AU	410	5	22	20.9	23.1	55	5	250	1	0.1	17	
BZT52-C24-AU	410	5	24	22.8	25.2	80	5	250	1	0.1	18	
BZT52-C27-AU	410	5	27	25.65	28.35	80	5	300	1	0.1	20	
BZT52-C28-AU	410	5	28	26.6	29.4	80	5	300	1	0.1	22	
BZT52-C30-AU	410	5	30	28.5	31.5	80	5	300	1	0.1	22.5	
BZT52-C33-AU	410	5	33	31.35	34.65	80	5	325	1	0.1	25	
BZT52-C36-AU	410	5	36	34.2	37.8	90	5	350	1	0.1	27	

Zener Diodes

Part Number	P _D	V _Z	V _Z @ I _{ZT} (V)			Z _{ZT} @ I _{ZT}	I _{ZT}	Z _{ZK} @ I _{ZK}	I _{ZK}	I _R @ V _R Max.		Package
	mW	%	Norm.	Min.	Max.	Ω	mA	Ω	mA	μA	V	
BZT52-C39-AU	410	5	39	37.05	40.95	90	5	350	1	0.1	29	SOD-123
BZT52-C43-AU	410	5	43	40.85	45.15	100	5	375	1	0.1	32	
BZT52-C47-AU	410	5	47	44.65	49.35	100	5	375	1	0.1	35	
BZT52-C51-AU	410	5	51	48.45	53.55	100	5	400	1	0.1	38	
BZT52-C56-AU	410	5	56	53.2	58.8	135	2.5	1000	1	0.1	42	
BZT52-C62-AU	410	5	62	58.9	65.1	150	2.5	1000	1	0.1	46	
BZT52-C68-AU	410	5	68	64.6	71.4	200	2.5	1000	1	0.1	51	
BZT52-C75-AU	410	5	75	71.25	78.75	250	2.5	1000	1	0.1	56	
MMSZ5229A-AU	500	2	4.3	4.21	4.39	22	20	2000	0.25	5	1	
MMSZ5230A-AU	500	2	4.7	4.61	4.79	19	20	1900	0.25	5	2	
MMSZ5231A-AU	500	2	5.1	5	5.2	17	20	1600	0.25	5	2	
MMSZ5232A-AU	500	2	5.6	5.49	5.71	11	20	1600	0.25	5	3	
MMSZ5234A-AU	500	2	6.2	6.08	6.32	7	20	1000	0.25	5	4	
MMSZ5235A-AU	500	2	6.8	6.66	6.94	5	20	750	0.25	3	5	
MMSZ5236A-AU	500	2	7.5	7.35	7.65	6	20	500	0.25	3	6	
MMSZ5237A-AU	500	2	8.2	8.04	8.36	8	20	500	0.25	3	6	
MMSZ5238A-AU	500	2	8.7	8.53	8.87	8	20	600	0.25	3	6.5	
MMSZ5239A-AU	500	2	9.1	8.92	9.28	10	20	600	0.25	3	6.5	
MMSZ5240A-AU	500	2	10	9.8	10.2	17	20	600	0.25	3	8	
MMSZ5241A-AU	500	2	11	10.78	11.22	22	20	600	0.25	2	8.4	
MMSZ5242A-AU	500	2	12	11.76	12.24	30	20	600	0.25	1	9.1	
MMSZ5243A-AU	500	2	13	12.74	13.26	13	9.5	600	0.25	0.5	9.9	
MMSZ5244A-AU	500	2	14	13.72	14.28	15	9	600	0.25	0.1	10.5	
MMSZ5245A-AU	500	2	15	14.7	15.3	16	8.5	600	0.25	0.1	11	
MMSZ5246A-AU	500	2	16	15.68	16.32	17	7.8	600	0.25	0.1	12	
MMSZ5247A-AU	500	2	17	16.66	17.34	19	7.5	600	0.25	0.1	13	
MMSZ5248A-AU	500	2	18	17.64	18.36	21	7	600	0.25	0.1	14	
MMSZ5250A-AU	500	2	20	19.6	20.4	25	6.2	600	0.25	0.1	15	
MMSZ5251A-AU	500	2	22	21.56	22.44	29	5.6	600	0.25	0.1	17	
MMSZ5252A-AU	500	2	24	23.52	24.48	33	5	600	0.25	0.1	18	
MMSZ5254A-AU	500	2	27	26.46	27.54	41	5	600	0.25	0.1	21	
MMSZ5255A-AU	500	2	28	27.44	28.56	44	4.5	600	0.25	0.1	21	
MMSZ5256A-AU	500	2	30	29.4	30.6	49	4.2	600	0.25	0.1	23	
MMSZ5257A-AU	500	2	33	32.34	33.66	58	3.8	700	0.25	0.1	25	
MMSZ5258A-AU	500	2	36	35.28	36.72	70	3.4	700	0.25	0.1	27	
MMSZ5259A-AU	500	2	39	38.22	39.78	80	3.2	800	0.25	0.1	30	
MMSZ5260A-AU	500	2	43	42.14	43.86	93	3	900	0.25	0.1	33	
MMSZ5261A-AU	500	2	47	46.06	47.94	105	2.7	1000	0.25	0.1	36	
MMSZ5262A-AU	500	2	51	49.98	52.02	125	2.5	1100	0.25	0.1	39	
MMSZ5221B-AU	500	5	2.4	2.28	2.52	30	20	1200	0.25	100	1	
MMSZ5222B-AU	500	5	2.5	2.38	2.63	30	20	1250	0.25	100	1	
MMSZ5223B-AU	500	5	2.7	2.57	2.84	30	20	1300	0.25	75	1	
MMSZ5224B-AU	500	5	2.8	2.66	2.94	30	20	1400	0.25	75	1	
MMSZ5225B-AU	500	5	3	2.85	3.15	30	20	1600	0.25	50	1	
MMSZ5226B-AU	500	5	3.3	3.14	3.47	28	20	1600	0.25	25	1	
MMSZ5227B-AU	500	5	3.6	3.42	3.78	24	20	1700	0.25	15	1	
MMSZ5228B-AU	500	5	3.9	3.71	4.1	23	20	1900	0.25	10	1	
PZS513V9BAS-AU	500	5	3.9	3.71	4.1	-	0.05	-	-	5	2	
MMSZ5229B-AU	500	5	4.3	4.09	4.52	22	20	2000	0.25	5	1	
PZS514V3BAS-AU	500	5	4.3	4.09	4.52	-	0.05	-	-	4	2	
MMSZ5230B-AU	500	5	4.7	4.47	4.94	19	20	1900	0.25	5	2	
PZS514V7BAS-AU	500	5	4.7	4.47	4.94	-	0.05	-	-	10	3	
MMSZ5231B-AU	500	5	5.1	4.85	5.36	17	20	1600	0.25	5	2	
PZS515V1BAS-AU	500	5	5.1	4.85	5.36	-	0.05	-	-	10	3	
PZS515V3BAS-AU	500	5	5.3	5.03	5.57	-	0.05	-	-	10	4	
MMSZ5232B-AU	500	5	5.6	5.32	5.88	11	20	1600	0.25	5	3	
PZS515V6BAS-AU	500	5	5.6	5.32	5.88	-	0.05	-	-	7	4.2	

Zener Diodes

Part Number	P _D	V _Z	V _Z @ I _{ZT} (V)			Z _{ZT} @ I _{ZT}	I _{ZT}	Z _{ZK} @ I _{ZK}	I _{ZK}	I _R @ V _R Max.		Package
	mW	%	Norm.	Min.	Max.	Ω	mA	Ω	mA	μA	V	
MMSZ5233B-AU	500	5	6	5.7	6.3	7	20	1600	0.25	5	3.5	SOD-123
MMSZ5234B-AU	500	5	6.2	5.89	6.51	7	20	1000	0.25	5	4	
PZS516V2BAS-AU	500	5	6.2	5.89	6.51	-	0.05	-	-	10	5	
MMSZ5235B-AU	500	5	6.8	6.46	7.14	5	20	750	0.25	3	5	
PZS516V8BAS-AU	500	5	6.8	6.46	7.14	-	0.05	-	-	10	5.1	
MMSZ5236B-AU	500	5	7.5	7.13	7.88	6	20	500	0.25	3	6	
PZS517V5BAS-AU	500	5	7.5	7.13	7.88	-	0.05	-	-	10	5.7	
MMSZ5237B-AU	500	5	8.2	7.79	8.61	8	20	500	0.25	3	6	
PZS518V2BAS-AU	500	5	8.2	7.79	8.61	-	0.05	-	-	1	6.2	
MMSZ5238B-AU	500	5	8.7	8.27	9.14	8	20	600	0.25	3	6.5	
PZS518V7BAS-AU	500	5	8.7	8.27	9.14	-	0.05	-	-	1	6.6	
MMSZ5239B-AU	500	5	9.1	8.65	9.56	10	20	600	0.25	3	6.5	
PZS519V1BAS-AU	500	5	9.1	8.65	9.56	-	0.05	-	-	1	6.9	
MMSZ5240B-AU	500	5	10	9.5	10.5	17	20	600	0.25	3	8	
PZS5110BAS-AU	500	5	10	9.5	10.5	-	0.05	-	-	1	7.6	
MMSZ5241B-AU	500	5	11	10.45	11.55	22	20	600	0.25	2	8.4	
PZS5111BAS-AU	500	5	11	10.5	11.6	-	0.05	-	-	0.05	8.4	
MMSZ5242B-AU	500	5	12	11.4	12.6	30	20	600	0.25	1	9.1	
PZS5112BAS-AU	500	5	12	11.4	12.6	-	0.05	-	-	0.05	9.1	
MMSZ5243B-AU	500	5	13	12.35	13.65	13	9.5	600	0.25	0.5	9.9	
PZS5113BAS-AU	500	5	13	12.4	13.7	-	0.05	-	-	0.05	9.8	
MMSZ5244B-AU	500	5	14	13.3	14.7	15	9	600	0.25	0.1	10.5	
PZS5114BAS-AU	500	5	14	13.3	14.7	-	0.05	-	-	0.05	10.6	
MMSZ5245B-AU	500	5	15	14.25	15.75	16	8.5	600	0.25	0.1	11	
PZS5115BAS-AU	500	5	15	14.3	15.8	-	0.05	-	-	0.05	11.4	
MMSZ5246B-AU	500	5	16	15.2	16.8	17	7.8	600	0.25	0.1	12	
PZS5116BAS-AU	500	5	16	15.2	16.8	-	0.05	-	-	0.05	12.1	
MMSZ5247B-AU	500	5	17	16.15	17.85	19	7.5	600	0.25	0.1	13	
PZS5117BAS-AU	500	5	17	16.2	17.9	-	0.05	-	-	0.05	12.9	
MMSZ5248B-AU	500	5	18	17.1	18.9	21	7	600	0.25	0.1	14	
PZS5118BAS-AU	500	5	18	17.1	18.9	-	0.05	-	-	0.05	13.6	
MMSZ5249B-AU	500	5	19	18.05	19.95	23	6.6	600	0.25	0.1	14	
PZS5119BAS-AU	500	5	19	18.1	20	-	0.05	-	-	0.05	14.4	
MMSZ5250B-AU	500	5	20	19	21	25	6.2	600	0.25	0.1	15	
PZS5120BAS-AU	500	5	20	19	21	-	0.05	-	-	0.01	15.2	
MMSZ5251B-AU	500	5	22	20.9	23.1	29	5.6	600	0.25	0.1	17	
PZS5122BAS-AU	500	5	22	20.9	23.1	-	0.05	-	-	0.01	16.7	
MMSZ5252B-AU	500	5	24	22.8	25.2	33	5.2	600	0.25	0.1	18	
PZS5124BAS-AU	500	5	24	22.8	25.2	-	0.05	-	-	0.01	18.2	
MMSZ5253B-AU	500	5	25	23.75	26.25	35	5	600	0.25	0.1	19	
PZS5125BAS-AU	500	5	25	23.8	26.3	-	0.05	-	-	0.01	19	
MMSZ5254B-AU	500	5	27	25.65	28.35	41	5	600	0.25	0.1	21	
PZS5127BAS-AU	500	5	27	25.7	28.4	-	0.05	-	-	0.01	20.4	
MMSZ5255B-AU	500	5	28	26.6	29.4	44	4.5	600	0.25	0.1	21	
PZS5128BAS-AU	500	5	28	26.6	29.4	-	0.05	-	-	0.01	21.2	
MMSZ5256B-AU	500	5	30	28.5	31.5	49	4.2	600	0.25	0.1	23	
PZS5130BAS-AU	500	5	30	28.5	31.5	-	0.05	-	-	0.01	22.8	
MMSZ5257B-AU	500	5	33	31.35	34.65	58	3.8	700	0.25	0.1	25	
PZS5133BAS-AU	500	5	33	31.4	34.7	-	0.05	-	-	0.01	25	
MMSZ5258B-AU	500	5	36	34.2	37.8	70	3.4	700	0.25	0.1	27	
PZS5136BAS-AU	500	5	36	34.2	37.8	-	0.05	-	-	0.01	27.3	
MMSZ5259B-AU	500	5	39	37.05	40.95	80	3.2	800	0.25	0.1	30	
PZS5139BAS-AU	500	5	39	37.1	41	-	0.05	-	-	0.01	29.6	
MMSZ5260B-AU	500	5	43	40.85	45.15	93	3	900	0.25	0.1	33	
PZS5143BAS-AU	500	5	43	40.9	45.2	-	0.05	-	-	0.01	32.6	
MMSZ5261B-AU	500	5	47	44.65	49.35	105	2.7	1000	0.25	0.1	36	
MMSZ5262B-AU	500	5	51	48.45	53.55	125	2.5	1100	0.25	0.1	39	

Zener Diodes

Part Number	P _D	V _Z	V _Z @ I _{ZT}			Z _{VT} @	I _{ZT}	Z _{ZK} @	I _{ZK}	I _R @ V _R		Package
	mW	%	Norm.	Min.	Max.	Ω	mA	Ω	mA	μA	V	
BZX84B2V4W-AU	200	2	2.4	2.35	2.45	100	5	600	1	50	1	SOT-323
BZX84B2V7W-AU	200	2	2.7	2.64	2.75	100	5	600	1	20	1	
BZX84B3W-AU	200	2	3	2.94	3.06	95	5	600	1	10	1	
BZX84B3V3W-AU	200	2	3.3	3.23	3.37	95	5	600	1	5	1	
BZX84B3V6W-AU	200	2	3.6	3.52	3.67	90	5	600	1	5	1	
BZX84B3V9W-AU	200	2	3.9	3.82	3.98	90	5	600	1	3	1	
BZX84B4V3W-AU	200	2	4.3	4.21	4.39	90	5	600	1	3	1	
BZX84B4V7W-AU	200	2	4.7	4.61	4.79	80	5	500	1	3	2	
BZX84B5V1W-AU	200	2	5.1	5	5.2	60	5	480	1	2	2	
BZX84B5V6W-AU	200	2	5.6	5.49	5.71	40	5	400	1	1	2	
BZX84B6V2W-AU	200	2	6.2	6.08	6.32	10	5	150	1	3	4	
BZX84B6V8W-AU	200	2	6.8	6.66	6.94	15	5	80	1	2	4	
BZX84B7V5W-AU	200	2	7.5	7.35	7.65	15	5	80	1	1	5	
BZX84B8V2W-AU	200	2	8.2	8.04	8.36	15	5	80	1	0.7	5	
BZX84B8V7W-AU	200	2	8.7	8.53	8.87	15	5	100	1	0.7	5	
BZX84B9V1W-AU	200	2	9.1	8.92	9.28	15	5	100	1	0.5	6	
BZX84B10W-AU	200	2	10	9.8	10.2	20	5	150	1	0.2	7	
BZX84B11W-AU	200	2	11	10.78	11.22	20	5	150	1	0.1	8	
BZX84B12W-AU	200	2	12	11.76	12.24	25	5	150	1	0.1	8	
BZX84B13W-AU	200	2	13	12.74	13.26	30	5	170	1	0.1	8	
BZX84B14W-AU	200	2	14	13.72	14.28	30	5	170	1	0.1	10	
BZX84B15W-AU	200	2	15	14.7	15.3	30	5	200	1	0.1	10.5	
BZX84B16W-AU	200	2	16	15.68	16.32	40	5	200	1	0.1	11.2	
BZX84B17W-AU	200	2	17	16.66	17.34	40	5	200	1	0.1	12.2	
BZX84B18W-AU	200	2	18	17.64	18.36	45	5	225	1	0.1	12.6	
BZX84B20W-AU	200	2	20	19.6	20.4	55	5	225	1	0.1	14	
BZX84B22W-AU	200	2	22	21.56	22.44	55	5	250	1	0.1	15.4	
BZX84B24W-AU	200	2	24	23.52	24.48	70	5	250	1	0.1	16.8	
BZX84B27W-AU	200	2	27	26.46	27.54	80	5	300	1	0.05	18.9	
BZX84B28W-AU	200	2	28	27.44	28.56	80	5	300	1	0.05	20.5	
BZX84B30W-AU	200	2	30	29.4	30.6	80	5	300	1	0.05	21	
BZX84B33W-AU	200	2	33	32.34	33.66	80	5	325	1	0.05	23.1	
BZX84B36W-AU	200	2	36	35.28	36.72	90	5	350	1	0.05	25.2	
BZX84B39W-AU	200	2	39	38.22	39.78	130	5	350	1	0.05	27.3	
BZX84B43W-AU	200	2	43	42.14	43.86	150	5	375	1	0.1	30.1	
BZX84B47W-AU	200	2	47	46.06	47.94	170	5	375	1	0.1	32.9	
BZX84B51W-AU	200	2	51	49.98	52.02	100	5	400	1	0.1	38	
BZX84B56W-AU	200	2	56	54.88	57.12	135	2.5	1000	1	0.05	42	
BZX84B62W-AU	200	2	62	60.76	63.24	150	2.5	1000	1	0.1	46	
BZX84B68W-AU	200	2	68	66.64	69.36	200	2.5	1000	1	0.1	51	
BZX84B75W-AU	200	2	75	73.5	76.5	250	2.5	1000	1	0.1	56	
PZD22B2V4C-AU	200	5	2.4	2.28	2.52	100	5	600	1	50	1	
BZX84C2V4W-AU	200	5	2.4	2.28	2.52	100	5	600	1	50	1	
PZD22B2V7C-AU	200	5	2.7	2.57	2.84	100	5	600	1	20	1	
BZX84C2V7W-AU	200	5	2.7	2.57	2.84	100	5	600	1	20	1	
PZD22B3V0C-AU	200	5	3	2.85	3.15	95	5	600	1	10	1	
BZX84C3W-AU	200	5	3	2.85	3.15	95	5	600	1	10	1	
PZD22B3V3C-AU	200	5	3.3	3.13	3.47	95	5	600	1	5	1	
BZX84C3V3W-AU	200	5	3.3	3.14	3.47	95	5	600	1	5	1	
PZD22B3V6C-AU	200	5	3.6	3.42	3.78	90	5	600	1	5	1	
BZX84C3V6W-AU	200	5	3.6	3.42	3.78	90	5	600	1	5	1	
PZD22B3V9C-AU	200	5	3.9	3.7	4.1	90	5	600	1	3	1	
BZX84C3V9W-AU	200	5	3.9	3.71	4.1	90	5	600	1	3	1	
PZD22B4V3C-AU	200	5	4.3	4.08	4.52	88	5	600	1	3	1	
BZX84C4V3W-AU	200	5	4.3	4.09	4.52	90	5	600	1	3	1	
PZD22B4V7C-AU	200	5	4.7	4.46	4.94	70	5	500	1	3	2	
BZX84C4V7W-AU	200	5	4.7	4.47	4.94	80	5	500	1	3	2	
PZD22B5V1C-AU	200	5	5.1	4.84	5.36	50	5	480	1	2	2	
BZX84C5V1W-AU	200	5	5.1	4.85	5.36	60	5	480	1	2	2	
PZD22B5V6C-AU	200	5	5.6	5.32	5.88	25	5	400	1	1	2	
BZX84C5V6W-AU	200	5	5.6	5.32	5.88	40	5	400	1	1	2	
PZD22B6V2C-AU	200	5	6.2	5.89	6.51	10	5	150	1	3	4	

Zener Diodes

Part Number	P _D	V _Z	V _Z @ I _{ZT}			Z _{ZT} @	I _{ZT}	Z _{ZK} @	I _{ZK}	I _R @ V _R		Package
	mW	%	Norm.	Min.	Max.	Ω	mA	Ω	mA	μA	V	
BZX84C6V2W-AU	200	5	6.2	5.89	6.51	10	5	150	1	3	4	SOT-323
PZD22B6V8C-AU	200	5	6.8	6.46	7.14	8	5	80	1	2	4	
BZX84C6V8W-AU	200	5	6.8	6.46	7.14	15	5	80	1	2	4	
PZD22B7V5C-AU	200	5	7.5	7.12	7.88	7	5	80	1	0.1	5	
BZX84C7V5W-AU	200	5	7.5	7.13	7.88	15	5	80	1	1	5	
PZD22B8V2C-AU	200	5	8.2	7.79	8.61	7	5	80	1	0.1	6	
BZX84C8V2W-AU	200	5	8.2	7.79	8.61	15	5	80	1	0.7	5	
PZD22B8V7C-AU	200	5	8.7	8.26	9.14	9	5	100	1	0.1	6.5	
BZX84C8V7W-AU	200	5	8.7	8.27	9.14	15	5	100	1	0.7	5	
PZD22B9V1C-AU	200	5	9.1	8.64	9.56	10	5	100	1	0.1	7	
BZX84C9V1W-AU	200	5	9.1	8.65	9.56	15	5	100	1	0.5	6	
PZD22B10C-AU	200	5	10	9.5	10.5	15	5	150	1	0.1	7.5	
BZX84C10W-AU	200	5	10	9.5	10.5	20	5	150	1	0.2	7	
PZD22B11C-AU	200	5	11	10.45	11.55	18	5	150	1	0.1	8.5	
BZX84C11W-AU	200	5	11	10.45	11.55	20	5	150	1	0.1	8	
PZD22B12C-AU	200	5	12	11.4	12.6	22	5	150	1	0.1	9	
BZX84C12W-AU	200	5	12	11.4	12.6	25	5	150	1	0.1	8	
PZD22B13C-AU	200	5	13	12.35	13.65	25	5	170	1	0.1	10	
BZX84C13W-AU	200	5	13	12.35	13.65	30	5	170	1	0.1	8	
PZD22B14C-AU	200	5	14	13.3	14.7	28	5	170	1	0.1	10.5	
BZX84C14W-AU	200	5	14	13.3	14.7	30	5	170	1	0.1	10	
PZD22B15C-AU	200	5	15	14.25	15.75	32	5	200	1	0.1	11	
BZX84C15W-AU	200	5	15	14.25	15.75	30	5	200	1	0.1	10.5	
PZD22B16C-AU	200	5	16	15.2	16.8	36	5	200	1	0.1	12	
BZX84C16W-AU	200	5	16	15.2	16.8	40	5	200	1	0.1	11.2	
PZD22B17C-AU	200	5	17	16.15	17.85	39	5	200	1	0.1	13	
BZX84C17W-AU	200	5	17	16.15	17.85	40	5	200	1	0.1	12.2	
PZD22B18C-AU	200	5	18	17.1	18.9	42	5	225	1	0.1	14	
BZX84C18W-AU	200	5	18	17.1	18.9	45	5	225	1	0.1	12.6	
PZD22B20C-AU	200	5	20	19	21	48	5	225	1	0.1	15	
BZX84C20W-AU	200	5	20	19	21	55	5	225	1	0.1	14	
PZD22B22C-AU	200	5	22	20.9	23.1	55	5	250	1	0.1	17	
BZX84C22W-AU	200	5	22	20.9	23.1	55	5	250	1	0.1	15.4	
PZD22B24C-AU	200	5	24	22.8	25.2	62	5	250	1	0.1	18	
BZX84C24W-AU	200	5	24	22.8	25.2	70	5	250	1	0.1	16.8	
PZD22B27C-AU	200	5	27	25.65	28.35	70	5	300	1	0.1	20	
BZX84C27W-AU	200	5	27	25.65	28.35	80	5	300	1	0.05	18.9	
BZX84C28W-AU	200	5	28	26.6	29.4	80	5	300	1	0.05	20.5	
PZD22B28C-AU	200	5	28	26.6	29.4	74	5	300	1	0.1	22	
PZD22B30C-AU	200	5	30	28.5	31.5	78	5	300	1	0.1	22.5	
BZX84C30W-AU	200	5	30	28.5	31.5	80	5	300	1	0.05	21	
BZX84C33W-AU	200	5	33	31.35	34.65	80	5	325	1	0.05	23.1	
PZD22B33C-AU	200	5	33	31.35	34.65	88	5	325	1	0.1	25	
BZX84C36W-AU	200	5	36	34.2	37.8	90	5	350	1	0.05	25.2	
PZD22B36C-AU	200	5	36	34.2	37.8	95	5	350	1	0.1	27	
PZD22B39C-AU	200	5	39	37.05	40.95	130	5	350	1	0.1	29	
BZX84C39W-AU	200	5	39	37.05	40.95	130	5	350	1	0.05	27.3	
PZD22B43C-AU	200	5	43	40.85	45.15	150	5	375	1	0.1	32	
BZX84C43W-AU	200	5	43	40.85	45.15	150	5	375	1	0.05	30.1	
PZD22B47C-AU	200	5	47	44.65	49.35	170	5	375	1	0.1	35	
BZX84C47W-AU	200	5	47	44.65	49.35	170	5	375	1	0.05	32.9	
BZX84C51W-AU	200	5	51	48.45	53.55	100	5	400	1	0.1	38	
PZD22B51C-AU	200	5	51	48.45	53.55	180	5	400	1	0.1	38	
BZX84C56W-AU	200	5	56	53.2	58.8	135	2.5	1000	1	0.1	42	
PZD22B56C-AU	200	5	56	53.2	58.8	200	2.5	1000	1	0.1	42	
PZD22B62C-AU	200	5	62	58.9	65.1	225	2.5	1000	1	0.1	46	
BZX84C62W-AU	200	5	62	58.9	65.1	150	2.5	1000	1	0.1	46	
PZD22B68C-AU	200	5	68	64.6	71.4	240	2.5	1000	1	0.1	51	
BZX84C68W-AU	200	5	68	64.6	71.4	200	2.5	1000	1	0.1	51	
PZD22B75C-AU	200	5	75	71.25	78.75	265	2.5	1000	1	0.1	56	
BZX84C75W-AU	200	5	75	71.25	78.75	250	2.5	1000	1	0.1	56	

Zener Diodes

Part Number	P _D	V _Z	V _Z @ I _{ZT} (V)			Z _{VT} @ I _{ZT}	I _{ZT}	Z _{ZK} @ I _{ZK}	I _{ZK}	I _R @ V _R Max.		Package
	mW	%	Norm.	Min.	Max.	Ω	mA	Ω	mA	μA	V	
BZX84C2V4TW-AU	200	5	2.4	2.28	2.52	100	5	600	1	50	1	SOT-363
BZX84C2V7TW-AU	200	5	2.7	2.565	2.835	100	5	600	1	20	1	
BZX84C3TW-AU	200	5	3	2.85	3.15	95	5	600	1	10	1	
BZX84C3V3TW-AU	200	5	3.3	3.135	3.465	95	5	600	1	5	1	
BZX84C3V6TW-AU	200	5	3.6	3.42	3.78	90	5	600	1	5	1	
BZX84C3V9TW-AU	200	5	3.9	3.705	4.095	90	5	600	1	3	1	
BZX84C4V3TW-AU	200	5	4.3	4.085	4.515	90	5	600	1	3	1	
BZX84C4V7TW-AU	200	5	4.7	4.465	4.935	80	5	500	1	3	2	
BZX84C5V1TW-AU	200	5	5.1	4.845	5.355	60	5	480	1	2	2	
BZX84C5V6TW-AU	200	5	5.6	5.32	5.88	40	5	400	1	1	2	
BZX84C6V2TW-AU	200	5	6.2	5.89	6.51	10	5	150	1	3	4	
BZX84C6V8TW-AU	200	5	6.8	6.46	7.14	15	5	80	1	2	4	
BZX84C7V5TW-AU	200	5	7.5	7.125	7.875	15	5	80	1	1	5	
BZX84C8V2TW-AU	200	5	8.2	7.79	8.61	15	5	80	1	0.7	5	
BZX84C8V7TW-AU	200	5	8.7	8.265	9.135	15	5	100	1	0.7	5	
BZX84C9V1TW-AU	200	5	9.1	8.645	9.555	15	5	100	1	0.5	6	
BZX84C10TW-AU	200	5	10	9.5	10.5	20	5	150	1	0.2	7	
BZX84C11TW-AU	200	5	11	10.45	11.55	20	5	150	1	0.1	8	
BZX84C12TW-AU	200	5	12	11.4	12.6	25	5	150	1	0.1	8	
BZX84C13TW-AU	200	5	13	12.35	13.65	30	5	170	1	0.1	8	
BZX84C14TW-AU	200	5	14	13.3	14.7	30	5	170	1	0.05	10	
BZX84C15TW-AU	200	5	15	14.25	15.75	30	5	200	1	0.05	10.5	
BZX84C16TW-AU	200	5	16	15.2	16.8	40	5	200	1	0.05	11.2	
BZX84C17TW-AU	200	5	17	16.15	17.85	40	5	200	1	0.05	12.2	
BZX84C18TW-AU	200	5	18	17.1	18.9	45	5	225	1	0.05	12.6	
BZX84C20TW-AU	200	5	20	19	21	55	5	225	1	0.05	14	
BZX84C22TW-AU	200	5	22	20.9	23.1	55	5	250	1	0.05	15.4	
BZX84C24TW-AU	200	5	24	22.8	25.2	70	5	250	1	0.05	16.8	
BZX84C27TW-AU	200	5	27	25.65	28.35	80	5	300	1	0.05	18.9	
BZX84C28TW-AU	200	5	28	26.6	29.4	80	5	300	1	0.05	20.5	
BZX84C30TW-AU	200	5	30	28.5	31.5	80	5	300	1	0.05	21	
BZX84C33TW-AU	200	5	33	31.35	34.65	80	5	325	1	0.05	23.1	
BZX84C36TW-AU	200	5	36	34.2	37.8	90	5	350	1	0.05	25.2	
BZX84C39TW-AU	200	5	39	37.05	40.95	130	5	350	1	0.05	27.3	
BZX84C43TW-AU	200	5	43	40.85	45.15	150	5	375	1	0.05	30.1	
BZX84C47TW-AU	200	5	47	44.65	49.35	170	5	375	1	0.05	32.9	
BZX84C51TW-AU	200	5	51	48.45	53.55	100	5	400	1	0.05	38	
BZX84C56TW-AU	200	5	56	53.2	58.8	135	2.5	1000	1	0.05	42	
BZX84C62TW-AU	200	5	62	58.9	65.1	150	2.5	1000	1	0.05	46	
BZX84C68TW-AU	200	5	68	64.6	71.4	200	2.5	1000	1	0.05	51	
BZX84C75TW-AU	200	5	75	71.25	78.75	250	2.5	1000	1	0.05	56	

Zener Diodes

Part Number	P _D	V _Z	V _Z @ I _{ZT}			Z _{ZT} @	I _{ZT}	Z _{ZK} @	I _{ZK}	I _R @ V _R		Package
	mW	%	Norm.	Min.	Max.	Ω	mA	Ω	mA	μA	V	
AZ23C2V4-AU	300	5	2.4	2.28	2.52	85	5	600	1	100	1	SOT-23
AZ23C2V7-AU	300	5	2.7	2.57	2.84	83	5	600	1	75	1	
AZ23C3V0-AU	300	5	3	2.85	3.15	95	5	600	1	50	1	
AZ23C3V3-AU	300	5	3.3	3.14	3.47	95	5	600	1	25	1	
AZ23C3V6-AU	300	5	3.6	3.42	3.78	95	5	600	1	15	1	
AZ23C3V9-AU	300	5	3.9	3.71	4.1	95	5	600	1	10	1	
AZ23C4V3-AU	300	5	4.3	4.09	4.52	95	5	600	1	5	1	
AZ23C4V7-AU	300	5	4.7	4.47	4.94	78	5	500	1	5	1	
AZ23C5V1-AU	300	5	5.1	4.85	5.36	60	5	480	1	0.1	0.8	
AZ23C5V6-AU	300	5	5.6	5.32	5.88	40	5	400	1	0.1	1	
AZ23C6V2-AU	300	5	6.2	5.89	6.51	10	5	150	1	0.1	2	
AZ23C6V8-AU	300	5	6.8	6.46	7.14	8	5	80	1	0.1	3	
AZ23C7V5-AU	300	5	7.5	7.13	7.88	7	5	80	1	0.1	5	
AZ23C8V2-AU	300	5	8.2	7.79	8.61	7	5	80	1	0.1	6	
AZ23C9V1-AU	300	5	9.1	8.65	9.56	10	5	100	1	0.1	7	
AZ23C10-AU	300	5	10	9.5	10.5	15	5	150	1	0.1	7.5	
AZ23C11-AU	300	5	11	10.45	11.55	20	5	150	1	0.1	8.5	
AZ23C12-AU	300	5	12	11.4	12.6	20	5	150	1	0.1	9	
AZ23C13-AU	300	5	13	12.35	13.65	25	5	170	1	0.1	10	
AZ23C15-AU	300	5	15	14.25	15.75	30	5	200	1	0.1	11	
AZ23C16-AU	300	5	16	15.2	16.8	40	5	200	1	0.1	12	
AZ23C18-AU	300	5	18	17.1	18.9	50	5	225	1	0.1	14	
AZ23C20-AU	300	5	20	19	21	50	5	225	1	0.1	15	
AZ23C22-AU	300	5	22	20.9	23.1	55	5	250	1	0.1	17	
AZ23C24-AU	300	5	24	22.8	25.2	80	5	250	1	0.1	18	
AZ23C27-AU	300	5	27	25.65	28.35	80	5	300	1	0.1	20	
DZ23C27-AU	300	5	27	25.65	28.35	80	5	300	1	0.1	20	
AZ23C36-AU	300	5	36	34.2	37.8	90	5	350	1	0.1	27	
BZX84B2V4-AU	410	2	2.4	2.35	2.45	100	5	600	1	50	1	
BZX84B2V7-AU	410	2	2.7	2.64	2.75	100	5	600	1	20	1	
BZX84B3-AU	410	2	3	2.94	3.06	95	5	600	1	10	1	
BZX84B3V3-AU	410	2	3.3	3.23	3.37	95	5	600	1	5	1	
BZX84B3V6-AU	410	2	3.6	3.52	3.67	90	5	600	1	5	1	
BZX84B3V9-AU	410	2	3.9	3.82	3.98	90	5	600	1	3	1	
BZX84B4V3-AU	410	2	4.3	4.21	4.39	90	5	600	1	3	1	
BZX84B4V7-AU	410	2	4.7	4.61	4.79	80	5	500	1	3	2	
BZX84B5V1-AU	410	2	5.1	5	5.2	60	5	480	1	2	2	
BZX84B5V6-AU	410	2	5.6	5.49	5.71	40	5	400	1	1	2	
BZX84B6V2-AU	410	2	6.2	6.08	6.32	10	5	150	1	3	4	
BZX84B6V8-AU	410	2	6.8	6.66	6.94	15	5	80	1	2	4	
BZX84B7V5-AU	410	2	7.5	7.35	7.65	15	5	80	1	1	5	
BZX84B8V2-AU	410	2	8.2	8.04	8.36	15	5	80	1	0.7	5	
BZX84B8V7-AU	410	2	8.7	8.53	8.87	15	5	100	1	0.7	5	
BZX84B9V1-AU	410	2	9.1	8.92	9.28	15	5	100	1	0.5	6	
BZX84B10-AU	410	2	10	9.8	10.2	20	5	150	1	0.2	7	
BZX84B11-AU	410	2	11	10.78	11.22	20	5	150	1	0.1	8	
BZX84B12-AU	410	2	12	11.76	12.24	25	5	150	1	0.1	8	
BZX84B13-AU	410	2	13	12.74	13.26	30	5	170	1	0.1	8	
BZX84B14-AU	410	2	14	13.72	14.28	30	5	170	1	0.1	10	
BZX84B15-AU	410	2	15	14.7	15.3	30	5	200	1	0.1	10.5	
BZX84B16-AU	410	2	16	15.68	16.32	40	5	200	1	0.1	11.2	
BZX84B17-AU	410	2	17	16.66	17.34	40	5	200	1	0.1	12.2	
BZX84B18-AU	410	2	18	17.64	18.36	45	5	225	1	0.1	12.6	
BZX84B20-AU	410	2	20	19.6	20.4	55	5	225	1	0.1	14	
BZX84B22-AU	410	2	22	21.56	22.44	55	5	250	1	0.1	15.4	
BZX84B24-AU	410	2	24	23.52	24.48	70	5	250	1	0.1	16.8	
BZX84B27-AU	410	2	27	26.46	27.54	80	5	300	1	0.05	18.9	
BZX84B28-AU	410	2	28	27.44	28.56	80	5	300	1	0.05	20.5	
BZX84B30-AU	410	2	30	29.4	30.6	80	5	300	1	0.05	21	
BZX84B33-AU	410	2	33	32.34	33.66	80	5	325	1	0.05	23.1	
BZX84B36-AU	410	2	36	35.28	36.72	90	5	350	1	0.05	25.2	
BZX84B39-AU	410	2	39	38.22	39.78	130	5	350	1	0.05	27.3	

Zener Diodes

Part Number	P _D	V _Z	V _Z @ I _{ZT} (V)			Z _{VT} @ I _{ZT}	I _{ZT}	Z _{ZK} @ I _{ZK}	I _{ZK}	I _R @ V _R Max.		Package
	mW	%	Norm.	Min.	Max.	Ω	mA	Ω	mA	μA	V	
BZX84B43-AU	410	2	43	42.14	43.86	150	5	375	1	0.05	30.1	SOT-23
BZX84B47-AU	410	2	47	46.06	47.94	170	5	375	1	0.05	32.9	
BZX84B51-AU	410	2	51	49.98	52.02	100	5	400	1	0.05	38	
BZX84B56-AU	410	2	56	54.88	57.12	135	2.5	1000	1	0.1	42	
BZX84B62-AU	410	2	62	60.76	63.24	150	2.5	1000	1	0.1	46	
BZX84B68-AU	410	2	68	66.64	69.36	200	2.5	1000	1	0.1	51	
BZX84B75-AU	410	2	75	73.5	76.5	250	2.5	1000	1	0.1	56	
BZX84C2V4-AU	410	5	2.4	2.28	2.52	100	5	600	1	50	1	
BZX84C2V7-AU	410	5	2.7	2.57	2.84	100	5	600	1	20	1	
BZX84C3-AU	410	5	3	2.85	3.15	95	5	600	1	10	1	
BZX84C3V3-AU	410	5	3.3	3.14	3.47	95	5	600	1	5	1	
BZX84C3V6-AU	410	5	3.6	3.42	3.78	90	5	600	1	5	1	
BZX84C3V9-AU	410	5	3.9	3.71	4.1	90	5	600	1	3	1	
MMBZ5228B-AU	410	5	3.9	3.71	4.1	23	20	1900	0.25	10	1	
BZX84C4V3-AU	410	5	4.3	4.09	4.52	90	5	600	1	3	1	
BZX84C4V7-AU	410	5	4.7	4.47	4.94	80	5	500	1	3	2	
MMBZ5230B-AU	410	5	4.7	4.47	4.94	19	20	1900	0.25	5	2	
BZX84C5V1-AU	410	5	5.1	4.85	5.36	60	5	480	1	2	2	
MMBZ5231B-AU	410	5	5.1	4.85	5.36	17	20	1600	0.25	5	2	
BZX84C5V6-AU	410	5	5.6	5.32	5.88	40	5	400	1	1	2	
MMBZ5232B-AU	410	5	5.6	5.32	5.88	11	20	1600	0.25	5	3	
MMBZ5233B-AU	410	5	6	5.7	6.3	7	20	1600	0.25	5	3.5	
BZX84C6V2-AU	410	5	6.2	5.89	6.51	10	5	150	1	3	4	
MMBZ5234B-AU	410	5	6.2	5.89	6.51	7	20	1000	0.25	5	4	
BZX84C6V8-AU	410	5	6.8	6.46	7.14	15	5	80	1	2	4	
MMBZ5235B-AU	410	5	6.8	6.46	7.14	5	20	750	0.25	3	5	
BZX84C7V5-AU	410	5	7.5	7.13	7.88	15	5	80	1	1	5	
MMBZ5236B-AU	410	5	7.5	7.13	7.88	6	20	500	0.25	3	6	
BZX84C8V2-AU	410	5	8.2	7.79	8.61	15	5	80	1	0.7	5	
MMBZ5237B-AU	410	5	8.2	7.79	8.61	8	20	500	0.25	3	6	
BZX84C8V7-AU	410	5	8.7	8.27	9.14	15	5	100	1	0.7	5	
MMBZ5238B-AU	410	5	8.7	8.27	9.14	8	20	600	0.25	3	6.5	
BZX84C9V1-AU	410	5	9.1	8.65	9.56	15	5	100	1	0.5	6	
MMBZ5239B-AU	410	5	9.1	8.65	9.56	10	20	600	0.25	3	6.5	
BZX84C10-AU	410	5	10	9.5	10.5	20	5	150	1	0.2	7	
MMBZ5240B-AU	410	5	10	9.5	10.5	17	20	600	0.25	3	8	
BZX84C11-AU	410	5	11	10.45	11.55	20	5	150	1	0.1	8	
MMBZ5241B-AU	410	5	11	10.45	11.55	22	20	600	0.25	2	8.4	
BZX84C12-AU	410	5	12	11.4	12.6	25	5	150	1	0.1	8	
MMBZ5242B-AU	410	5	12	11.4	12.6	30	20	600	0.25	1	9.1	
BZX84C13-AU	410	5	13	12.35	13.65	30	5	170	1	0.1	8	
MMBZ5243B-AU	410	5	13	12.35	13.65	13	9.5	600	0.25	0.5	9.9	
BZX84C14-AU	410	5	14	13.3	14.7	30	5	170	1	0.1	10	
MMBZ5244B-AU	410	5	14	13.3	14.7	15	9	600	0.25	0.1	10.5	
BZX84C15-AU	410	5	15	14.25	15.75	30	5	200	1	0.1	10.5	
MMBZ5245B-AU	410	5	15	14.25	15.75	16	8.5	600	0.25	0.1	11	
BZX84C16-AU	410	5	16	15.2	16.8	40	5	200	1	0.1	11.2	
MMBZ5246B-AU	410	5	16	15.2	16.8	17	7.8	600	0.25	0.1	12	
BZX84C17-AU	410	5	17	16.15	17.85	40	5	200	1	0.1	12.2	
MMBZ5247B-AU	410	5	17	16.15	17.85	19	7.5	600	0.25	0.1	13	
BZX84C18-AU	410	5	18	17.1	18.9	45	5	225	1	0.1	12.6	
MMBZ5248B-AU	410	5	18	17.1	18.9	21	7	600	0.25	0.1	14	
BZX84C20-AU	410	5	20	19	21	55	5	225	1	0.1	14	
MMBZ5250B-AU	410	5	20	19	21	25	6.2	600	0.25	0.1	15	
BZX84C22-AU	410	5	22	20.9	23.1	55	5	250	1	0.1	15.4	
MMBZ5251B-AU	410	5	22	20.9	23.1	29	5.6	600	0.25	0.1	17	
BZX84C24-AU	410	5	24	22.8	25.2	70	5	250	1	0.1	16.8	
MMBZ5252B-AU	410	5	24	22.8	25.2	33	5.2	600	0.25	0.1	18	
BZX84C27-AU	410	5	27	25.65	28.35	80	5	300	1	0.05	18.9	
MMBZ5254B-AU	410	5	27	25.65	28.35	41	5	600	0.25	0.1	21	
BZX84C28-AU	410	5	28	26.6	29.4	80	5	300	1	0.05	20.5	
MMBZ5255B-AU	410	5	28	26.6	29.4	44	4.5	600	0.25	0.1	21	

Zener Diodes

Part Number	P _D	V _Z	V _Z @ I _{ZT}			Z _{VT} @	I _{ZT}	Z _{ZK} @	I _{ZK}	I _R @ V _R		Package	
	mW	%	Norm.	Min.	Max.	Ω	mA	Ω	mA	μA	V		
BZX84C30-AU	410	5	30	28.5	31.5	80	5	300	1	0.05	21	SOT-23	
MMBZ5256B-AU	410	5	30	28.5	31.5	49	4.2	600	0.25	0.1	23		
BZX84C33-AU	410	5	33	31.35	34.65	80	5	325	1	0.05	23.1		
MMBZ5257B-AU	410	5	33	31.35	34.65	58	3.8	700	0.25	0.1	25		
BZX84C36-AU	410	5	36	34.2	37.8	90	5	350	1	0.05	25.2		
MMBZ5258B-AU	410	5	36	34.2	37.8	70	3.4	700	0.25	0.1	27		
BZX84C39-AU	410	5	39	37.05	40.95	130	5	350	1	0.05	27.3		
MMBZ5259B-AU	410	5	39	37.05	40.95	80	3.2	800	0.25	0.1	30		
BZX84C43-AU	410	5	43	40.85	45.15	150	5	375	1	0.1	30.1		
MMBZ5260B-AU	410	5	43	40.85	45.15	93	3	900	0.25	0.1	33		
BZX84C47-AU	410	5	47	44.65	49.35	170	5	375	1	0.1	32.9		
MMBZ5261B-AU	410	5	47	44.65	49.35	105	2.7	1000	0.25	0.1	36		
BZX84C51-AU	410	5	51	48.45	53.55	100	5	400	1	0.1	38		
MMBZ5262B-AU	410	5	51	48.45	53.55	125	2.5	1100	0.25	0.1	39		
BZX84C56-AU	410	5	56	53.2	58.8	135	2.5	1000	1	0.1	42		
BZX84C62-AU	410	5	62	58.9	65.1	150	2.5	1000	1	0.1	46		
BZX84C68-AU	410	5	68	64.6	71.4	200	2.5	1000	1	0.1	51		
BZX84C75-AU	410	5	75	71.25	78.75	250	2.5	1000	1	0.1	56		
1SMA4728-AU	1000	5	3.3	3.1	3.5	10	76	400	1	100	1		SMA
1SMA4730-AU	1000	5	3.9	3.7	4.1	9	64	400	1	50	1		
1SMA4731-AU	1000	5	4.3	4.1	4.5	9	58	400	1	10	1		
1SMA4732-AU	1000	5	4.7	4.5	4.9	8	53	500	1	10	1		
1SMA4733-AU	1000	5	5.1	4.8	5.4	7	49	550	1	10	1		
1SMA4734-AU	1000	5	5.6	5.3	5.9	5	45	600	1	10	2		
1SMA4735-AU	1000	5	6.2	5.9	6.5	2	41	700	1	10	3		
1SMA4736-AU	1000	5	6.8	6.46	7.14	3.5	37	700	1	5	4		
1SMA4737-AU	1000	5	7.5	7.125	7.875	4	34	700	0.5	5	5		
1SMA4738-AU	1000	5	8.2	7.79	8.61	4.5	31	700	0.5	5	6		
1SMA4739-AU	1000	5	9.1	8.645	9.555	5	28	700	0.5	0.5	7		
1SMA4740-AU	1000	5	10	9.5	10.5	7	25	700	0.25	0.5	7.6		
1SMA4741-AU	1000	5	11	10.45	11.55	8	23	700	0.25	0.1	8.4		
1SMA4742-AU	1000	5	12	11.4	12.6	9	21	700	0.25	0.1	9.1		
1SMA4743-AU	1000	5	13	12.35	13.65	10	19	700	0.25	0.1	9.9		
1SMA4744-AU	1000	5	15	14.25	15.75	14	17	700	0.25	0.1	11.4		
1SMA4745-AU	1000	5	16	15.2	16.8	16	15.5	700	0.25	0.1	12.2		
1SMA4746-AU	1000	5	18	17.1	18.9	20	14	750	0.25	0.1	13.7		
1SMA4747-AU	1000	5	20	19	21	22	12.5	750	0.25	0.1	15.2		
1SMA4748-AU	1000	5	22	20.9	23.1	23	11.5	750	0.25	0.1	16.7		
1SMA4749-AU	1000	5	24	22.8	25.2	25	10.5	750	0.25	0.1	18.2		
1SMA4750-AU	1000	5	27	25.65	28.35	35	9.5	750	0.25	0.1	20.6		
1SMA4751-AU	1000	5	30	28.5	31.5	40	8.5	1000	0.25	0.1	22.8		
1SMA4752-AU	1000	5	33	31.35	34.65	45	7.5	1000	0.25	0.1	25.1		
1SMA4753-AU	1000	5	36	34.2	37.8	50	7	1000	0.25	0.1	27.4		
1SMA4754-AU	1000	5	39	37.05	40.95	60	6.5	1000	0.25	0.1	29.7		
1SMA4755-AU	1000	5	43	40.85	45.15	70	6	1500	0.25	0.1	32.7		
1SMA4756-AU	1000	5	47	44.65	49.35	80	5.5	1500	0.25	0.1	35.8		
1SMA4757-AU	1000	5	51	48.45	53.55	95	5	1500	0.25	0.1	38.8		
1SMA5914-AU	1500	5	3.6	3.42	3.78	104.2	9	500	1	75	1		
1SMA5915-AU	1500	5	3.9	3.71	4.1	96.1	8	500	1	25	1		
1SMA5916-AU	1500	5	4.3	4.09	4.52	87.2	6	500	1	5	1		
1SMA5917-AU	1500	5	4.7	4.47	4.94	79.8	5	500	1	5	1.5		
1SMA5918-AU	1500	5	5.1	4.85	5.36	73.5	4	350	1	5	2		
1SMA5919-AU	1500	5	5.6	5.32	5.88	66.9	2	250	1	5	3		
1SMA5920-AU	1500	5	6.2	5.89	6.51	60.5	2	200	1	5	4		
1SMA5921-AU	1500	5	6.8	6.46	7.14	3	55.1	200	1	5	5.2		
1SMA5922-AU	1500	5	7.5	7.13	7.88	3	50	400	0.5	5	6		
1SMA5923-AU	1500	5	8.2	7.79	8.61	4	45.7	400	0.5	5	6.5		
1SMA5924-AU	1500	5	9.1	8.65	9.56	4	41.2	500	0.5	5	7		
1SMA5925-AU	1500	5	10	9.5	10.5	5	37.5	500	0.25	5	8		
1SMA5926-AU	1500	5	11	10.45	11.55	6	34.1	550	0.25	1	8.4		
1SMA5927-AU	1500	5	12	11.4	12.6	7	31.2	550	0.25	1	9.1		
1SMA5928-AU	1500	5	13	12.35	13.65	7	28.8	550	0.25	1	9.9		

Zener Diodes

Part Number	P_D	V_Z	$V_Z @ I_{ZT}$ (V)			$Z_{ZT} @$ I_{ZT}	I_{ZT}	$Z_{ZK} @$ I_{ZK}	I_{ZK}	$I_R @ V_R$ Max.		Package
	mW	%	Norm.	Min.	Max.	Ω	mA	Ω	mA	μA	V	
1SMA5929-AU	1500	5	15	14.25	15.75	9	25	600	0.25	1	11.4	SMA
1SMA5930-AU	1500	5	16	15.2	16.8	10	23.4	600	0.25	1	12.2	
1SMA5931-AU	1500	5	18	17.1	18.9	12	20.8	650	0.25	1	13.7	
1SMA5932-AU	1500	5	20	19	21	14	18.7	650	0.25	1	15.2	
1SMA5933-AU	1500	5	22	20.9	23.1	18	17	650	0.25	1	16.7	
1SMA5934-AU	1500	5	24	22.8	25.2	19	15.6	700	0.25	1	18.2	
1SMA5935-AU	1500	5	27	25.65	28.35	23	13.9	700	0.25	1	20.6	
1SMA5936-AU	1500	5	30	28.5	31.5	26	12.5	750	0.25	1	22.8	
1SMA5937-AU	1500	5	33	31.35	34.65	33	11.4	800	0.25	1	25.1	
1SMA5938-AU	1500	5	36	34.2	37.8	38	10.4	850	0.25	1	27.4	
1SMA5939-AU	1500	5	39	37.05	40.95	45	9.6	900	0.25	1	29.7	
1SMA5940-AU	1500	5	43	40.85	45.15	53	8.7	950	0.25	1	32.7	
1SMA5941-AU	1500	5	47	44.65	49.35	67	8	1000	0.25	1	35.8	
1SMA5942-AU	1500	5	51	48.45	53.55	70	7.3	1100	0.25	1	38.8	
1SMA5943-AU	1500	5	56	53.2	58.8	86	6.7	1300	0.25	1	42.6	
1SMA5944-AU	1500	5	62	58.9	65.1	100	6	1500	0.25	1	47.1	
1SMA5945-AU	1500	5	68	64.6	71.4	120	5.5	1700	0.25	1	51.7	

Zener Diodes

Part Number	P _D	V _Z	V _Z @ I _{ZT}			Z _{ZT} @	I _{ZT}	Z _{ZK} @	I _{ZK}	I _R @ V _R		Package
	mW	%	Norm.	Min.	Max.	Ω	mA	Ω	mA	μA	V	
1SMB5921-AU	1500	5	6.8	6.46	7.14	3	55.1	200	1	5	5.2	SMB
1SMB5922-AU	1500	5	7.5	7.13	7.88	3	50	400	0.5	5	6	
1SMB5923-AU	1500	5	8.2	7.79	8.61	4	45.7	400	0.5	5	6.5	
1SMB5924-AU	1500	5	9.1	8.65	9.56	4	41.2	500	0.5	5	7	
1SMB5925-AU	1500	5	10	9.5	10.5	5	37.5	500	0.25	5	8	
1SMB5926-AU	1500	5	11	10.45	11.55	6	34.1	550	0.25	1	8.4	
1SMB5927-AU	1500	5	12	11.4	12.6	7	31.2	550	0.25	1	9.1	
1SMB5928-AU	1500	5	13	12.35	13.65	7	28.8	550	0.25	1	9.9	
1SMB5929-AU	1500	5	15	14.25	15.75	9	25	600	0.25	1	11.4	
1SMB5930-AU	1500	5	16	15.2	16.8	10	23.4	600	0.25	1	12.2	
1SMB5931-AU	1500	5	18	17.1	18.9	12	20.8	650	0.25	1	13.7	
1SMB5932-AU	1500	5	20	19	21	14	18.7	650	0.25	1	15.2	
1SMB5933-AU	1500	5	22	20.9	23.1	18	17	650	0.25	1	16.7	
1SMB5934-AU	1500	5	24	22.8	25.2	19	15.6	700	0.25	1	18.2	
1SMB5935-AU	1500	5	27	25.65	28.35	23	13.9	700	0.25	1	20.6	
1SMB5936-AU	1500	5	30	28.5	31.5	26	12.5	750	0.25	1	22.8	
1SMB5937-AU	1500	5	33	31.35	34.65	33	11.4	800	0.25	1	25.1	
1SMB5938-AU	1500	5	36	34.2	37.8	38	10.4	850	0.25	1	27.4	
1SMB5939-AU	1500	5	39	37.05	40.95	45	9.6	900	0.25	1	29.7	
1SMB5940-AU	1500	5	43	40.85	45.15	53	8.7	950	0.25	1	32.7	
1SMB5941-AU	1500	5	47	44.65	49.35	67	8	1000	0.25	1	35.8	
1SMB5942-AU	1500	5	51	48.45	53.55	70	7.3	1100	0.25	1	38.8	
1SMB2EZ6.8-AU	2000	5	6.8	6.46	7.14	2	73.5	700	1	5	4	
1SMB2EZ7.5-AU	2000	5	7.5	7.125	7.875	2	66.5	700	0.5	5	5	
1SMB2EZ8.2-AU	2000	5	8.2	7.79	8.61	2.3	61	700	0.5	5	6	
1SMB2EZ8.7-AU	2000	5	8.7	8.265	9.135	2.4	58	700	0.5	4	6.6	
1SMB2EZ9.1-AU	2000	5	9.1	8.645	9.555	2.5	55	700	0.5	3	7	
1SMB2EZ10-AU	2000	5	10	9.5	10.5	3.5	50	700	0.25	3	7.6	
1SMB2EZ11-AU	2000	5	11	10.45	11.55	4	45.5	700	0.25	1	8.4	
1SMB2EZ12-AU	2000	5	12	11.4	12.6	4.5	41.5	700	0.25	1	9.1	
1SMB2EZ13-AU	2000	5	13	12.35	13.65	5	38.5	700	0.25	0.5	9.9	
1SMB2EZ14-AU	2000	5	14	13.3	14.7	5.5	35.7	700	0.25	0.5	10.6	
1SMB2EZ15-AU	2000	5	15	14.25	15.75	7	33.4	700	0.25	0.5	11.4	
1SMB2EZ16-AU	2000	5	16	15.2	16.8	8	31.2	700	0.25	0.5	12.2	
1SMB2EZ17-AU	2000	5	17	16.15	17.85	9	29.4	750	0.25	0.5	13	
1SMB2EZ18-AU	2000	5	18	17.1	18.9	10	27.8	750	0.25	0.5	13.7	
1SMB2EZ19-AU	2000	5	19	18.05	19.95	11	26.3	750	0.25	0.5	14.4	
1SMB2EZ20-AU	2000	5	20	19	21	11	25	750	0.25	0.5	15.2	
1SMB2EZ22-AU	2000	5	22	20.9	23.1	12	22.8	750	0.25	0.5	16.7	
1SMB2EZ24-AU	2000	5	24	22.8	25.2	13	20.8	750	0.25	0.5	18.2	
1SMB2EZ25-AU	2000	5	25	23.75	26.25	14	20	750	0.25	0.5	19	
1SMB2EZ27-AU	2000	5	27	25.65	28.35	18	18.5	750	0.25	0.5	20.6	
1SMB2EZ28-AU	2000	5	28	26.6	29.4	18	17	750	0.25	0.5	21.3	
1SMB2EZ30-AU	2000	5	30	28.5	31.5	20	16.6	1000	0.25	0.5	22.5	
1SMB2EZ33-AU	2000	5	33	31.35	34.65	23	15.1	1000	0.25	0.5	25.1	
1SMB2EZ36-AU	2000	5	36	34.2	37.8	25	13.9	1000	0.25	0.5	27.4	
1SMB2EZ39-AU	2000	5	39	37.05	40.95	30	12.8	1000	0.25	0.5	29.7	
1SMB2EZ43-AU	2000	5	43	40.85	45.15	35	11.6	1500	0.25	0.5	32.7	
1SMB2EZ47-AU	2000	5	47	44.65	49.35	40	10.6	1500	0.25	0.5	35.8	
1SMB2EZ51-AU	2000	5	51	48.45	53.55	48	9.8	1500	0.25	0.5	38.8	
1SMB3EZ5.6-AU	3000	5	5.6	5.32	5.88	2	134	700	1	5	3	
1SMB3EZ6.2-AU	3000	5	6.2	5.89	6.51	2	120	700	1	5	4	
1SMB3EZ6.8-AU	3000	5	6.8	6.46	7.14	2	110	700	1	5	4	
1SMB3EZ7.5-AU	3000	5	7.5	7.125	7.875	2	100	700	0.5	5	5	
1SMB3EZ8.2-AU	3000	5	8.2	7.79	8.61	2.3	91	700	0.5	5	6	
1SMB3EZ8.7-AU	3000	5	8.7	8.265	9.135	2.4	85	700	0.5	4	6.6	

Zener Diodes

Part Number	P _D mW	V _Z %	V _Z @ I _{ZT} (V)			Z _{ZT} @ I _{ZT}	I _{ZT}	Z _{ZK} @ I _{ZK}	I _{ZK}	I _R @ V _R Max.		Package
			Norm.	Min.	Max.	Ω	mA	Ω	mA	μA	V	
1SMB3EZ9.1-AU	3000	5	9.1	8.645	9.555	2.5	82	700	0.5	3	7	SMB
1SMB3EZ10-AU	3000	5	10	9.5	10.5	3.5	75	700	0.25	3	7.6	
1SMB3EZ11-AU	3000	5	11	10.45	11.55	4	68	700	0.25	1	8.4	
1SMB3EZ12-AU	3000	5	12	11.4	12.6	4.5	63	700	0.25	1	9.1	
1SMB3EZ13-AU	3000	5	13	12.35	13.65	4.5	58	700	0.25	0.5	9.9	
1SMB3EZ14-AU	3000	5	14	13.3	14.7	5	53	700	0.25	0.5	10.6	
1SMB3EZ15-AU	3000	5	15	14.25	15.75	5.5	50	700	0.25	0.5	11.4	
1SMB3EZ16-AU	3000	5	16	15.2	16.8	5.5	47	700	0.25	0.5	12.2	
1SMB3EZ17-AU	3000	5	17	16.15	17.85	6	44	750	0.25	0.5	13	
1SMB3EZ18-AU	3000	5	18	17.1	18.9	6	42	750	0.25	0.5	13.7	
1SMB3EZ19-AU	3000	5	19	18.05	19.95	7	40	750	0.25	0.5	14.4	
1SMB3EZ20-AU	3000	5	20	19	21	7	37	750	0.25	0.5	15.2	
1SMB3EZ22-AU	3000	5	22	20.9	23.1	8	34	750	0.25	0.5	16.7	
1SMB3EZ24-AU	3000	5	24	22.8	25.2	9	31	750	0.25	0.5	18.2	
1SMB3EZ25-AU	3000	5	25	23.75	26.25	9.5	30	750	0.25	0.5	19	
1SMB3EZ27-AU	3000	5	27	25.65	28.35	10	28	750	0.25	0.5	20.6	
1SMB3EZ28-AU	3000	5	28	26.6	29.4	12	27	750	0.25	0.5	21.3	
1SMB3EZ30-AU	3000	5	30	28.5	31.5	16	25	1000	0.25	0.5	22.5	
1SMB3EZ33-AU	3000	5	33	31.35	34.65	20	23	1000	0.25	0.5	25.1	
1SMB3EZ36-AU	3000	5	36	34.2	37.8	22	21	1000	0.25	0.5	27.4	
1SMB3EZ39-AU	3000	5	39	37.05	40.95	28	19	1000	0.25	0.5	29.7	
1SMB3EZ43-AU	3000	5	43	40.85	45.15	33	17	1500	0.25	0.5	32.7	
1SMB3EZ47-AU	3000	5	47	44.65	49.35	38	16	1500	0.25	0.5	35.8	
1SMB3EZ51-AU	3000	5	51	48.45	53.55	45	15	1500	0.25	0.5	38.8	
1SMC5338-AU	5000	5	5.1	4.85	5.36	2	240	400	1	10	1	
1SMC5339-AU	5000	5	5.6	5.32	5.88	1	220	400	1	10	2	
1SMC5340-AU	5000	5	6	5.7	6.3	1	200	300	1	10	3	
1SMC5341-AU	5000	5	6.2	5.89	6.51	1	200	200	1	10	3	
1SMC5342-AU	5000	5	6.8	6.46	7.14	1	175	200	1	10	5.2	
1SMC5343-AU	5000	5	7.5	7.13	7.88	2	175	200	1	10	5.7	
1SMC5344-AU	5000	5	8.2	7.79	8.61	2	150	200	1	10	6.2	
1SMC5345-AU	5000	5	8.7	8.27	9.14	2	150	200	1	10	6.6	
1SMC5346-AU	5000	5	9.1	8.65	9.56	2	150	150	1	7.5	6.9	
1SMC5347-AU	5000	5	10	9.5	10.5	2	125	125	1	5	7.6	
1SMC5348-AU	5000	5	11	10.45	11.55	3	125	125	1	5	8.4	
1SMC5349-AU	5000	5	12	11.4	12.6	3	100	125	1	2	9.1	
1SMC5350-AU	5000	5	13	12.35	13.65	3	100	100	1	1	9.9	
1SMC5351-AU	5000	5	14	13.3	14.7	3	100	75	1	1	10.6	
1SMC5352-AU	5000	5	15	14.25	15.75	3	75	75	1	1	11.5	
1SMC5353-AU	5000	5	16	15.2	16.8	3	75	75	1	1	12.2	
1SMC5354-AU	5000	5	17	16.15	17.85	3	70	75	1	0.5	12.9	
1SMC5355-AU	5000	5	18	17.1	18.9	3	65	75	1	0.5	13.7	
1SMC5356-AU	5000	5	19	18.05	19.95	3	65	75	1	0.5	14.4	
1SMC5357-AU	5000	5	20	19	21	3	65	75	1	0.5	15.2	
1SMC5358-AU	5000	5	22	20.9	23.1	4	50	75	1	0.5	16.7	
1SMC5359-AU	5000	5	24	22.8	25.2	4	50	100	1	0.5	18.2	
1SMC5360-AU	5000	5	25	23.75	26.25	4	50	110	1	0.5	19	
1SMC5361-AU	5000	5	27	25.65	28.35	5	50	120	1	0.5	20.6	
1SMC5362-AU	5000	5	28	26.6	29.4	6	50	130	1	0.5	21.2	
1SMC5363-AU	5000	5	30	28.5	31.5	8	40	140	1	0.5	22.8	
1SMC5364-AU	5000	5	33	31.35	34.65	10	40	150	1	0.5	25.1	
1SMC5365-AU	5000	5	36	34.2	37.8	11	30	160	1	0.5	27.4	
1SMC5366-AU	5000	5	39	37.05	40.95	14	30	170	1	0.5	29.7	
1SMC5367-AU	5000	5	43	40.85	45.15	20	30	190	1	0.5	32.7	
1SMC5368-AU	5000	5	47	44.65	49.35	25	25	210	1	0.5	35.8	
1SMC5369-AU	5000	5	51	48.45	53.55	27	25	230	1	0.5	38.8	

ESD Protection

Part Number	UNI/BI	Ch.	V _{RWM}	V _{BR}	I _R @ V _{RWM}	V _C @ I _{PP}	I _{PP}	C _J	Package
			Max.	Min.	Max.	Max.	A	Max.	
			V	V	μA	V	A	pF	
PEC1605M1Q-AU	BI	1	5.5	6.8	0.075	12	1	0.6	DFN 2L
PJE5UFN10A-AU	UNI	4	5	6	1	13	2.5	0.8	DFN2510-10L
PJSD03TS-AU	UNI	1	3.3	4	200	6.5	5	200	SOD-523
PJSD05TS-02-AU	UNI	1	5	6	1	14	15	160	
PJSD05TS-AU	UNI	1	5	6	5	9	5	110	
PJSD07TS-AU	UNI	1	7	7.5	0.15	22.7	8.8	85	
PJSD08TS-AU	UNI	1	8	8.5	5	13	5	70	
PJSD12TS-AU	UNI	1	12	13.3	5	17	5	60	
PJSD15TS-AU	UNI	1	15	16.6	5	22	5	50	
PJSD24TS-AU	UNI	1	24	26.7	5	32	3	25	
PJSD36TS-AU	UNI	1	36	40	5	55	1	20	
PJGBLC03C-AU	BI	1	3	4.75	20	7.5	1	3	
PJSD05CW-AU	BI	1	5	6.37	5	14.5	24	200	
PJGBLC05C-AU	BI	1	5	7.03	5	9.8	1	3	
PEC3808CS-AU	BI	1	8	8.5	0.5	18	8	70	
PJGBLC08C-AU	BI	1	8	8.93	1	13.4	1	3	
PEC3212C1CS-AU	BI	1	12	13	0.1	23	5	20	
PEC3812CS-AU	BI	1	12	13	0.5	27	5	45	
PJSD12CW-AU	BI	1	12	13.3	1	24	15	100	
PJGBLC12C-AU	BI	1	12	13.97	1	19	1	3	
PEC3815CS-AU	BI	1	15	16	0.5	33	4	40	
PJSD15CW-AU	BI	1	15	16.72	1	29	10	75	
PJGBLC15C-AU	BI	1	15	17.39	1	24	1	3	
PJEC2415VM1WS-AU	BI	1	24	25.4	0.05	50	3	17	
PEC3824CS-AU	BI	1	24	25.5	0.05	45	3	20	
PJSD24CW-AU	BI	1	24	26.6	1	42	4	50	
PJGBLC24C-AU	BI	1	24	27.27	1	43	1	3	
PEC3836CS-AU	BI	1	36	37.5	0.05	70	1.5	15	
PJSD36CW-AU	BI	1	36	40.57	1	71	3	45	
PJSD03W-AU	UNI	1	3	4	125	6.5	1	540	
PJGBLC03-AU	UNI	1	3	4.75	20	7.5	1	3	
PJSD05W-AU	UNI	1	5	6	10	9.8	1	360	
PJGBLC05-AU	UNI	1	5	7.03	5	9.8	1	3	
PJSD08W-AU	UNI	1	8	8.5	10	13.4	1	180	
PJGBLC08-AU	UNI	1	8	8.93	1	13.4	1	3	
PJSD12W-AU	UNI	1	12	13.3	1	19	1	160	
PJGBLC12-AU	UNI	1	12	13.97	1	19	1	3	
PJSD15W-AU	UNI	1	15	16.7	1	24	1	150	
PJGBLC15-AU	UNI	1	15	17.39	1	24	1	3	
PJSD24W-AU	UNI	1	24	26.6	1	43	1	100	
PJGBLC24-AU	UNI	1	24	27.27	1	43	1	3	
PJSD36W-AU	UNI	1	36	39.9	1	60	1	40	

ESD Protection

Part Number	UNI/BI	Ch.	V _{RWM}	V _{BR}	I _R @ V _{RWM}	V _C @ I _{PP}	I _{PP}	C _J	Package	
			Max.	Min.	Max.	Max.	A	Max.		
			V	V	μA	V	A	pF		
PEC3808AS-AU	BI	1	8	8.5	0.5	18	8	70	SOD-123	
PEC3812AS-AU	BI	1	12	13	0.5	27	5	45		
PEC3815AS-AU	BI	1	15	16	0.5	33	4	40		
PEC3824AS-AU	BI	1	24	25.5	0.05	45	3	20		
PEC3836AS-AU	BI	1	36	37.5	0.05	70	1.5	15		
PEC3808C2E-AU	BI	2	8	8.5	0.5	18	8	70	SOT-523	
PEC3812C2E-AU	BI	2	12	13	0.5	27	5	45		
PEC3815C2E-AU	BI	2	15	16	0.5	33	4	40		
PEC3824C2E-AU	BI	2	24	25.5	0.05	45	3	20		
PEC3836C2E-AU	BI	2	36	37.5	0.05	70	1.5	15		
PJE5V0U8TB-AU	UNI	2	5	5.8	1	15	4	0.8	SOT-563	
PE1605C4E6-AU	UNI	4	5.5	6	1	15	4	0.6		
PEC3808C2C-AU	BI	2	8	8.5	0.5	18	8	70	SOT-323	
PEC3812C2C-AU	BI	2	12	13	0.5	27	5	45		
PEC3815C2C-AU	BI	2	15	16	0.5	33	4	40		
PEC3824C2C-AU	BI	2	24	25.5	0.05	45	3	20		
PEC3836C2C-AU	BI	2	36	37.5	0.05	70	1.5	15		
PE1605C4C6-AU	UNI	4	5.5	6	1	10	1	0.6	SOT-363	
PEC3808C2A-AU	BI	2	8	8.5	0.5	18	8	70	SOT-23	
PEC3812C2A-AU	BI	2	12	13	0.5	27	5	45		
PJEC12VM1TA-AU	BI	2	12	14	0.05	25	3	10		
PEC3815C2A-AU	BI	2	15	16	0.5	33	4	40		
PEC3215C2A-AU	BI	2	15	17	1	24	1	20		
PJEC24MTA-AU	BI	2	24	25.4	0.05	50	4	15		
PEC3124C2A-AU	BI	2	24	25.4	0.05	60	3	15		
PEC3824C2A-AU	BI	2	24	25.5	0.05	45	3	20		
PEC3324C2A-AU	BI	2	24	26.2	0.05	34	1	30		
PEC3836C2A-AU	BI	2	36	37.5	0.05	70	1.5	15		
PE9180C1A-AU	BI	2	80	100	0.03	11	20	2		
PJSOT36-AU	UNI	1	36	40	1	51	9	80		
PJMBZ5V6A-AU	UNI	2	3	5.32	5	8	3	-		
PJMBZ6V2A-AU	UNI	2	3	5.89	0.5	8.7	2.76	-		
PJMBZ6V8A-AU	UNI	2	4.5	6.46	0.5	9.6	2.5	-		
PJMBZ9V1A-AU	UNI	2	6	8.65	0.3	14	1.7	-		
PJMBZ12A-AU	UNI	2	8.5	11.4	0.2	17	2.35	-		
PJMBZ15A-AU	UNI	2	12	14.25	0.05	21	1.9	-		
PJMBZ15V-AU	UNI	2	12	14.3	0.1	24	6	80		
PJMBZ18A-AU	UNI	2	14.5	17.1	0.05	25	1.6	-		
PJMBZ20A-AU	UNI	2	17	19	0.05	28	1.4	-		
PJMBZ27A-AU	UNI	2	22	25.65	0.05	40	1	-		
PJMBZ27V-AU	UNI	2	22	25.65	0.05	36	4	50		
PJSOT24C-05-AU	UNI	2	24	26.7	1	43	12	150		
PJMBZ33A-AU	UNI	2	26	31.35	0.05	46	0.87	-		
PE4136C2A-AU	UNI	2	36	40	0.8	60	1	100		
PJSOT36C-05-AU	UNI	2	36	40	1	75	9	100		
PE1605C4A6-AU	UNI	4	5.5	6	1	10	1	0.6	SOT-23 6L	

Transient Voltage Suppressors

Part Number	UNI/BI	P _D	V _{RWM}	V _{BR} @ I _T		I _T	I _R @ V _{RWM}	V _C @ I _{PP}	I _{PP}	Package
		W	V	Min.	Max.	mA	µA	Max. V	A	
P1CH3.3A-AU	UNI	150	3.3	5.2	6	10	50	8.5	17.6	SOD-323HE
P1CH5.0A-AU	UNI	150	5	6.4	7	10	5	9.2	16.3	
P1CH6.0A-AU	UNI	150	6	6.67	7.37	10	5	10.3	14.5	
P1CH6.5A-AU	UNI	150	6.5	7.22	7.98	10	4	11.2	13.4	
P1CH7.0A-AU	UNI	150	7	7.78	8.6	10	4	12	12.5	
P1CH7.5A-AU	UNI	150	7.5	8.33	9.21	1	3	12.9	11.6	
P1CH8.0A-AU	UNI	150	8	8.89	9.83	1	2	13.6	11	
P1CH8.5A-AU	UNI	150	8.5	9.44	10.4	1	2	14.4	10.4	
P1CH9.0A-AU	UNI	150	9	10	11.1	1	1	15.4	9.7	
P1CH10A-AU	UNI	150	10	11.1	12.3	1	1	17	8.8	
P1CH11A-AU	UNI	150	11	12.2	13.5	1	1	18.2	8.2	
P1CH12A-AU	UNI	150	12	13.3	14.7	1	1	19.9	7.5	
P1CH13A-AU	UNI	150	13	14.4	15.9	1	0.5	21.5	7	
P1CH14A-AU	UNI	150	14	15.6	17.2	1	0.5	23.2	6.5	
P1CH15A-AU	UNI	150	15	16.7	18.5	1	0.5	24.4	6.1	
P1CH16A-AU	UNI	150	16	17.8	19.7	1	0.5	26	5.8	
P1CH17A-AU	UNI	150	17	18.9	20.9	1	0.5	27.6	5.3	
P1CH18A-AU	UNI	150	18	20	22.1	1	0.5	29.2	5.1	
P1CH20A-AU	UNI	150	20	22	24.5	1	0.5	32.4	4.6	
P1CH22A-AU	UNI	150	22	24.4	26.9	1	0.5	35.5	4.2	
P1CH24A-AU	UNI	150	24	26.7	29.5	1	0.5	38.9	3.9	
P1CH26A-AU	UNI	150	26	28.9	31.9	1	0.5	42.1	3.6	
P1CH28A-AU	UNI	150	28	31.1	34.4	1	0.5	45.4	3.3	
P1CH30A-AU	UNI	150	30	33.3	36.8	1	0.5	48.4	3.1	
P1CH33A-AU	UNI	150	33	36.7	40.6	1	0.5	53.3	2.8	
P1CH36A-AU	UNI	150	36	40	44.2	1	0.5	58.1	2.6	
P2AL3.3A-AU	UNI	200	3.3	5.2	6	10	50	8.5	23.5	SOD-123FL
P2AL5.0A-AU	UNI	200	5	6.4	7	10	25	9.2	21.7	
P2AL6.0A-AU	UNI	200	6	6.67	7.37	10	25	10.3	19.4	
P2AL6.5A-AU	UNI	200	6.5	7.22	7.98	10	20	11.2	17.9	
P2AL7.0A-AU	UNI	200	7	7.78	8.6	10	20	12	16.7	
P2AL7.5A-AU	UNI	200	7.5	8.33	9.21	1	15	12.9	15.5	
P2AL8.0A-AU	UNI	200	8	8.89	9.83	1	2	13.6	14.7	
SMF8.5A-AU	UNI	200	8.5	9.4	10.4	1	10	14.4	13.9	
P2AL8.5A-AU	UNI	200	8.5	9.44	10.4	1	2	14.4	13.9	
P2AL9.0A-AU	UNI	200	9	10	11.1	1	0.5	15.4	13	
SMF9.0A-AU	UNI	200	9	10	11.1	1	5	15.4	13	
P2AL10A-AU	UNI	200	10	11.1	12.3	1	0.5	17	11.8	
SMF10A-AU	UNI	200	10	11.1	12.3	1	2.5	17	11.8	
P2AL11A-AU	UNI	200	11	12.2	13.5	1	0.5	18.2	11	
SMF11A-AU	UNI	200	11	12.2	13.5	1	2.5	18.2	11	
P2AL12A-AU	UNI	200	12	13.3	14.7	1	0.5	19.9	10.1	
SMF12A-AU	UNI	200	12	13.3	14.7	1	2.5	19.9	10.1	
P2AL13A-AU	UNI	200	13	14.4	15.9	1	0.1	21.5	9.3	
SMF13A-AU	UNI	200	13	14.4	15.9	1	1	21.5	9.3	
P2AL14A-AU	UNI	200	14	15.6	17.2	1	0.1	23.2	8.6	
SMF14A-AU	UNI	200	14	15.6	17.2	1	1	23.2	8.6	
P2AL15A-AU	UNI	200	15	16.7	18.5	1	0.1	24.4	8.2	
SMF15A-AU	UNI	200	15	16.7	18.5	1	1	24.4	8.2	
P2AL16A-AU	UNI	200	16	17.8	19.7	1	0.1	26	7.7	
SMF16A-AU	UNI	200	16	17.8	19.7	1	1	26	7.7	
P2AL17A-AU	UNI	200	17	18.9	20.9	1	0.1	27.6	7.2	
SMF17A-AU	UNI	200	17	18.9	20.9	1	1	27.6	7.2	
P2AL18A-AU	UNI	200	18	20	22.1	1	0.1	29.2	6.8	
SMF18A-AU	UNI	200	18	20	22.1	1	1	29.2	6.8	
P2AL20A-AU	UNI	200	20	22	24.5	1	0.1	32.4	6.2	
SMF20A-AU	UNI	200	20	22.2	24.5	1	1	32.4	6.2	
P2AL22A-AU	UNI	200	22	24.4	26.9	1	0.1	35.5	5.6	
SMF22A-AU	UNI	200	22	24.4	26.9	1	1	35.5	5.6	
P2AL24A-AU	UNI	200	24	26.7	29.5	1	0.1	38.9	5.1	
SMF24A-AU	UNI	200	24	26.7	29.5	1	1	38.9	5.1	
P2AL26A-AU	UNI	200	26	28.9	31.9	1	0.1	42.1	4.8	
SMF26A-AU	UNI	200	26	28.9	31.9	1	1	42.1	4.8	
P2AL28A-AU	UNI	200	28	31.1	34.4	1	0.1	45.4	4.4	
SMF28A-AU	UNI	200	28	31.1	34.4	1	1	45.4	4.4	
P2AL30A-AU	UNI	200	30	33.3	36.8	1	0.1	48.4	4.1	
SMF30A-AU	UNI	200	30	33.3	36.8	1	1	48.4	4.1	
P2AL33A-AU	UNI	200	33	36.7	40.6	1	0.1	53.3	3.8	
SMF33A-AU	UNI	200	33	36.7	40.6	1	1	53.3	3.8	

Transient Voltage Suppressors

Part Number	UNI/BI	P _D	V _{RWM}	V _{BR} @ I _T		I _T	I _R @ V _{RWM}	V _C @ I _{PP}	I _{PP}	Package
		W	V	Min.	Max.	mA	μA	Max. V	A	
P2AL36A-AU	UNI	200	36	40	44.2	1	0.1	58.1	3.4	SOD-123FL
SMF36A-AU	UNI	200	36	40	44.2	1	1	58.1	3.4	
P2AL40A-AU	UNI	200	40	44.4	49.1	1	0.1	64.5	3.1	
SMF40A-AU	UNI	200	40	44.4	49.1	1	1	64.5	3.1	
SMF43A-AU	UNI	200	43	47.8	52.8	1	1	69.4	2.9	
SMF45A-AU	UNI	200	45	50	55.3	1	1	72.7	2.8	
SMF48A-AU	UNI	200	48	53.3	58.9	1	1	77.4	2.6	
SMF51A-AU	UNI	200	51	56.7	62.7	1	1	82.4	2.4	
SMF54A-AU	UNI	200	54	60	66.3	1	1	87.1	2.3	
SMF58A-AU	UNI	200	58	64.4	71.2	1	1	93.6	2.1	
SMF60A-AU	UNI	200	60	66.7	73.7	1	1	96.8	1.8	
SMF64A-AU	UNI	200	64	71.1	78.6	1	1	103	1.7	
SMF70A-AU	UNI	200	70	77.8	86	1	1	113	1.5	
P4FL3.3A-AU	UNI	400	3.3	5.2	6	10	100	8.5	47	
P4FL5.0A-AU	UNI	400	5	6.4	7	10	50	9.2	43.5	
P4FL6.0A-AU	UNI	400	6	6.67	7.37	10	50	10.3	38.8	
P4FL6.5A-AU	UNI	400	6.5	7.22	7.98	10	40	11.2	35.7	
P4FL7.0A-AU	UNI	400	7	7.78	8.6	10	40	12	33.3	
P4FL7.5A-AU	UNI	400	7.5	8.33	9.21	1	30	12.9	31	
P4FL8.0A-AU	UNI	400	8	8.89	9.83	1	5	13.6	29.4	
P4FL8.5A-AU	UNI	400	8.5	9.44	10.4	1	5	14.4	27.8	
P4FL9.0A-AU	UNI	400	9	10	11.1	1	0.5	15.4	26	
P4FL10A-AU	UNI	400	10	11.1	12.3	1	0.5	17	23.5	
P4FL11A-AU	UNI	400	11	12.2	13.5	1	0.5	18.2	22	
P4FL12A-AU	UNI	400	12	13.3	14.7	1	0.5	19.9	20.1	
P4FL13A-AU	UNI	400	13	14.4	15.9	1	0.1	21.5	18.6	
P4FL14A-AU	UNI	400	14	15.6	17.2	1	0.1	23.2	17.2	
P4FL15A-AU	UNI	400	15	16.7	18.5	1	0.1	24.4	16.4	
P4FL16A-AU	UNI	400	16	17.8	19.7	1	0.1	26	15.4	
P4FL17A-AU	UNI	400	17	18.9	20.9	1	0.1	27.6	14.5	
P4FL18A-AU	UNI	400	18	20	22.1	1	0.1	29.2	13.7	
P4FL20A-AU	UNI	400	20	22	24.5	1	0.1	32.4	12.3	
P4FL22A-AU	UNI	400	22	24.4	26.9	1	0.1	35.5	11.3	
P4FL24A-AU	UNI	400	24	26.7	29.5	1	0.1	38.9	10.3	
P4FL26A-AU	UNI	400	26	28.9	31.9	1	0.1	42.1	9.5	
P4FL28A-AU	UNI	400	28	31.1	34.4	1	0.1	45.4	8.8	
P4FL30A-AU	UNI	400	30	33.3	36.8	1	0.1	48.4	8.3	
P4FL33A-AU	UNI	400	33	36.7	40.6	1	0.1	53.3	7.5	
P4FL36A-AU	UNI	400	36	40	44.2	1	0.1	58.1	6.9	
P4FL40A-AU	UNI	400	40	44.4	49.1	1	0.1	64.5	6.2	
P4FL43A-AU	UNI	400	43	47.8	52.8	1	0.1	69.4	5.8	
P4FL45A-AU	UNI	400	45	50	55.3	1	0.1	72.2	5.5	
P4FL48A-AU	UNI	400	48	53.3	58.9	1	0.1	77.4	5.2	
P4FL51A-AU	UNI	400	51	56.7	62.7	1	0.1	82.4	4.9	
P4FL54A-AU	UNI	400	54	60	66.3	1	0.1	87.1	4.6	
P4FL58A-AU	UNI	400	58	64.4	71.2	1	0.1	93.6	4.3	
P4FL60A-AU	UNI	400	60	66.7	73.7	1	0.1	96.8	4.1	
P4FL64A-AU	UNI	400	64	71.1	78.6	1	0.1	103	3.9	
P4HE3.3A-AU	UNI	400	3.3	5.2	6	10	100	8.5	47	
P4HE5.0A-AU	UNI	400	5	6.4	7	10	50	9.2	43.5	
P4HE6.0A-AU	UNI	400	6	6.67	7.37	10	50	10.3	38.8	
P4HE6.5A-AU	UNI	400	6.5	7.22	7.98	10	40	11.2	35.7	
P4HE7.0A-AU	UNI	400	7	7.78	8.6	10	40	12	33.3	
P4HE7.5A-AU	UNI	400	7.5	8.33	9.21	1	30	12.9	31	
P4HE8.0A-AU	UNI	400	8	8.89	9.83	1	5	13.6	29.4	
P4HE8.5A-AU	UNI	400	8.5	9.44	10.4	1	5	14.4	27.8	
P4HE9.0A-AU	UNI	400	9	10	11.1	1	0.5	15.4	26	
P4HE10A-AU	UNI	400	10	11.1	12.3	1	0.5	17	23.5	
P4HE11A-AU	UNI	400	11	12.2	13.5	1	0.5	18.2	22	
P4HE12A-AU	UNI	400	12	13.3	14.7	1	0.5	19.9	20.1	
P4HE13A-AU	UNI	400	13	14.4	15.9	1	0.1	21.5	18.6	
P4HE14A-AU	UNI	400	14	15.6	17.2	1	0.1	23.2	17.2	
P4HE15A-AU	UNI	400	15	16.7	18.5	1	0.1	24.4	16.4	
P4HE16A-AU	UNI	400	16	17.8	19.7	1	0.1	26	15.4	
P4HE17A-AU	UNI	400	17	18.9	20.9	1	0.1	27.6	14.5	
P4HE18A-AU	UNI	400	18	20	22.1	1	0.1	29.2	13.7	
P4HE20A-AU	UNI	400	20	22.2	24.5	1	0.1	32.4	12.3	
P4HE22A-AU	UNI	400	22	24.4	26.9	1	0.1	35.5	11.3	
P4HE24A-AU	UNI	400	24	26.7	29.5	1	0.1	38.9	10.3	

Transient Voltage Suppressors

Part Number	UNI/BI	P _D	V _{RWM}	V _{BR} @ I _T		I _T	I _R @ V _{RWM}	V _C @ I _{PP}	I _{PP}	Package
		W	V	Min.	Max.	mA	μA	Max. V	A	
P4HE26A-AU	UNI	400	26	28.9	31.9	1	0.1	42.1	9.5	SOD-123HE
P4HE28A-AU	UNI	400	28	31.1	34.4	1	0.1	45.4	8.8	
P4HE30A-AU	UNI	400	30	33.3	36.8	1	0.1	48.4	8.3	
P4HE33A-AU	UNI	400	33	36.7	40.6	1	0.1	53.3	7.5	
P4HE36A-AU	UNI	400	36	40	44.2	1	0.1	58.1	6.9	
P4HE40A-AU	UNI	400	40	44.4	49.1	1	0.1	64.5	6.2	
P4HE43A-AU	UNI	400	43	47.8	52.8	1	0.1	69.4	5.8	
P4HE45A-AU	UNI	400	45	50	55.3	1	0.1	72.7	5.5	
P4HE48A-AU	UNI	400	48	53.3	58.9	1	0.1	77.4	5.2	
P4HE51A-AU	UNI	400	51	56.7	62.7	1	0.1	82.4	4.9	
P4HE54A-AU	UNI	400	54	60	66.3	1	0.1	87.1	4.6	
P4HE58A-AU	UNI	400	58	64.4	71.2	1	0.1	93.6	4.3	
P4HE60A-AU	UNI	400	60	66.7	73.7	1	0.1	96.8	4.1	
P4HE64A-AU	UNI	400	64	71.1	78.6	1	0.1	103	3.9	
P4AFC8.5AS-AU	UNI	400	8.5	9.44	10.82	1	10	14.4	27.7	
P4AFC9.0AS-AU	UNI	400	9	10	11.5	1	5	15.4	26	
P4AFC10AS-AU	UNI	400	10	11.1	12.8	1	5	17	23.5	
P4AFC11AS-AU	UNI	400	11	12.2	14	1	1	18.2	22	
P4AFC12AS-AU	UNI	400	12	13.3	15.3	1	1	19.9	20.1	
P4AFC13AS-AU	UNI	400	13	14.4	16.5	1	1	21.5	18.6	
P4AFC14AS-AU	UNI	400	14	15.6	17.9	1	1	23.2	17.2	
P4AFC15AS-AU	UNI	400	15	16.7	19.2	1	1	24.4	16.4	
P4AFC16AS-AU	UNI	400	16	17.8	20.5	1	1	26	15.3	
P4AFC17AS-AU	UNI	400	17	18.9	21.7	1	1	27.6	14.5	
P4AFC18AS-AU	UNI	400	18	20	23.3	1	1	29.2	13.7	
P4AFC20AS-AU	UNI	400	20	22.2	25.5	1	1	32.4	12.3	
P4AFC22AS-AU	UNI	400	22	24.4	28	1	1	35.5	11.2	
P4AFC24AS-AU	UNI	400	24	26.7	30.7	1	1	38.9	10.3	
P4AFC26AS-AU	UNI	400	26	28.9	33.2	1	1	42.1	9.5	
P4AFC28AS-AU	UNI	400	28	31.1	35.8	1	1	45.4	8.8	
P4AFC30AS-AU	UNI	400	30	33.3	38.3	1	1	48.4	8.3	
P4AFC33AS-AU	UNI	400	33	36.7	42.2	1	1	53.3	7.5	
P4AFC36AS-AU	UNI	400	36	40	46	1	1	58.1	6.9	
P4AFC40AS-AU	UNI	400	40	44.4	51.1	1	1	64.5	6.2	
P4AFC43AS-AU	UNI	400	43	47.8	54.9	1	1	69.4	5.7	
P4AFC45AS-AU	UNI	400	45	50	57.5	1	1	72.7	5.5	
P4AFC48AS-AU	UNI	400	48	53.3	61.3	1	1	77.4	5.2	
P4AFC51AS-AU	UNI	400	51	56.7	65.2	1	1	82.4	4.9	
P4AFC54AS-AU	UNI	400	54	60	69	1	1	87.1	4.6	
P4AFC58AS-AU	UNI	400	58	64.4	74.1	1	1	93.6	4.3	
P4AFC60AS-AU	UNI	400	60	66.7	76.7	1	1	96.8	4.1	
P4AFC64AS-AU	UNI	400	64	71.1	81.8	1	1	103	3.9	
P4AFC70AS-AU	UNI	400	70	77.8	89.5	1	1	113	3.5	
P4AFC75AS-AU	UNI	400	75	83.3	95.8	1	1	121	3.3	
P4AFC78AS-AU	UNI	400	78	86.7	99.7	1	1	126	3.2	
P4AFC85AS-AU	UNI	400	85	94.4	108.2	1	1	137	2.9	
P4AFC90AS-AU	UNI	400	90	100	115.5	1	1	146	2.7	
P4AFC100AS-AU	UNI	400	100	111	128	1	1	162	2.5	
P4AFC110AS-AU	UNI	400	110	122	140.5	1	1	177	2.3	
P4AFC120AS-AU	UNI	400	120	133	153	1	1	193	2	
P4AFC130AS-AU	UNI	400	130	144	165.5	1	1	209	1.9	
P4AFC150AS-AU	UNI	400	150	167	192.5	1	1	243	1.6	
P4AFC160AS-AU	UNI	400	160	178	205	1	1	259	1.5	
P4AFC170AS-AU	UNI	400	170	189	217.5	1	1	275	1.4	
P4AFC180AS-AU	UNI	400	180	198	221	1	1	291	1.4	
P4AFC190AS-AU	UNI	400	190	209	233	1	1	307	1.3	
P4AFC200AS-AU	UNI	400	200	220	246	1	1	324	1.2	
P4AFC220AS-AU	UNI	400	220	246	272	1	1	356	1.1	
P6AFC3.3A-AU	UNI	600	3.3	5.2	6	10	100	8	75	SMAFC
P6AFC5.0A-AU	UNI	600	5	6.4	7	10	50	9.2	65.2	
P6AFC6.0A-AU	UNI	600	6	6.67	7.37	10	50	10.3	58.3	
P6AFC6.5A-AU	UNI	600	6.5	7.22	7.98	10	40	11.2	53.6	
P6AFC7.0A-AU	UNI	600	7	7.78	8.6	10	40	12	50	
P6AFC7.5A-AU	UNI	600	7.5	8.33	9.21	1	30	12.9	46.5	
P6AFC8.0A-AU	UNI	600	8	8.89	9.83	1	5	13.6	44.1	
P6AFC8.5A-AU	UNI	600	8.5	9.44	10.4	1	5	14.4	41.7	
P6AFC9.0A-AU	UNI	600	9	10	11.1	1	0.5	15.4	39	
P6AFC10A-AU	UNI	600	10	11.1	12.3	1	0.5	17	35.3	
P6AFC11A-AU	UNI	600	11	12.2	13.5	1	0.5	18.2	33	

Transient Voltage Suppressors

Part Number	UNI/BI	P _D	V _{RWM}	V _{BR} @ I _T (V)		I _T	I _R @ V _{RWM} (μA)	V _C @ I _{PP} Max.	I _{PP}	Package
		W	V	Min.	Max.	mA	μA	V	A	
P6AFC6.0A-AU	UNI	600	6	6.67	7.37	10	50	10.3	58.3	SMAFC
P6AFC6.5A-AU	UNI	600	6.5	7.22	7.98	10	40	11.2	53.6	
P6AFC7.0A-AU	UNI	600	7	7.78	8.6	10	40	12	50	
P6AFC7.5A-AU	UNI	600	7.5	8.33	9.21	1	30	12.9	46.5	
P6AFC8.0A-AU	UNI	600	8	8.89	9.83	1	5	13.6	44.1	
P6AFC8.5A-AU	UNI	600	8.5	9.44	10.4	1	5	14.4	41.7	
P6AFC9.0A-AU	UNI	600	9	10	11.1	1	0.5	15.4	39	
P6AFC10A-AU	UNI	600	10	11.1	12.3	1	0.5	17	35.3	
P6AFC11A-AU	UNI	600	11	12.2	13.5	1	0.5	18.2	33	
P6AFC12A-AU	UNI	600	12	13.3	14.7	1	0.5	19.9	30.2	
P6AFC13A-AU	UNI	600	13	14.4	15.9	1	0.1	21.5	27.9	
P6AFC14A-AU	UNI	600	14	15.6	17.2	1	0.1	23.2	25.9	
P6AFC15A-AU	UNI	600	15	16.7	18.5	1	0.1	24.4	24.6	
P6AFC16A-AU	UNI	600	16	17.8	19.7	1	0.1	26	23.1	
P6AFC17A-AU	UNI	600	17	18.9	20.9	1	0.1	27.6	21.7	
P6AFC18A-AU	UNI	600	18	20	22.1	1	0.1	29.2	20.5	
P6AFC20A-AU	UNI	600	20	22.2	24.5	1	0.1	32.4	18.5	
P6AFC22A-AU	UNI	600	22	24.4	26.9	1	0.1	35.5	16.9	
P6AFC24A-AU	UNI	600	24	26.7	29.5	1	0.1	38.9	15.4	
P6AFC26A-AU	UNI	600	26	28.9	31.9	1	0.1	42.1	14.3	
P6AFC28A-AU	UNI	600	28	31.1	34.4	1	0.1	45.4	13.2	
P6AFC30A-AU	UNI	600	30	33.3	36.8	1	0.1	48.4	12.4	
P6AFC33A-AU	UNI	600	33	36.7	40.6	1	0.1	53.3	11.3	
P6AFC36A-AU	UNI	600	36	40	44.2	1	0.1	58.1	10.3	
P6AFC40A-AU	UNI	600	40	44.4	49.1	1	0.1	64.5	9.3	
P6AFC43A-AU	UNI	600	43	47.8	52.8	1	0.1	69.4	8.6	
P6AFC45A-AU	UNI	600	45	50	55.3	1	0.1	72.7	8.3	
P6AFC48A-AU	UNI	600	48	53.3	58.9	1	0.1	77.4	7.8	
P6AFC51A-AU	UNI	600	51	56.7	62.7	1	0.1	82.4	7.3	
P6AFC54A-AU	UNI	600	54	60	66.3	1	0.1	87.1	6.9	
P6AFC58A-AU	UNI	600	58	64.4	71.2	1	0.1	93.6	6.4	
P6AFC60A-AU	UNI	600	60	66.7	73.7	1	0.1	96.8	6.2	
P6AFC64A-AU	UNI	600	64	71.1	78.6	1	0.1	103	5.8	

Transient Voltage Suppressors

Part Number	UNI/BI	P _D	V _{RWM}	V _{BR} @ I _T		I _T	I _R @ V _{RWM}	V _C @ I _{PP}	I _{PP}	Package
		W	V	Min.	Max.	mA	μA	Max. V	A	
P4SMAJ8.5CA-AU	BI	400	8.5	9.44	10.4	1	20	14.4	27.7	SMA
P4SMA10CA-AU	BI	400	8.55	9.5	10.5	1	20	14.5	29	
P4SMAJ9.0CA-AU	BI	400	9	10	11.1	1	5	15.4	26	
P4SMA11CA-AU	BI	400	9.4	10.5	11.6	1	10	15.6	27	
P4SMAJ10CA-AU	BI	400	10	11.1	12.3	1	5	17	23.5	
P4SMA12CA-AU	BI	400	10.2	11.4	12.6	1	1	16.7	25	
P4SMAJ11CA-AU	BI	400	11	12.2	13.5	1	1	18.2	22	
P4SMA13CA-AU	BI	400	11.1	12.4	13.7	1	1	18.2	23	
P4SMAJ12CA-AU	BI	400	12	13.3	14.7	1	1	19.9	20.1	
P4SMA15CA-AU	BI	400	12.8	14.3	15.8	1	1	21.2	20	
P4SMAJ13CA-AU	BI	400	13	14.4	15.9	1	1	21.5	18.6	
P4SMA16CA-AU	BI	400	13.6	15.2	16.8	1	1	22.5	19	
P4SMAJ14CA-AU	BI	400	14	15.6	17.2	1	1	23.2	17.2	
P4SMAJ15CA-AU	BI	400	15	16.7	18.5	1	1	24.4	16.4	
P4SMA18CA-AU	BI	400	15.3	17.1	18.9	1	1	25.2	17	
P4SMAJ16CA-AU	BI	400	16	17.8	19.7	1	1	26	15.3	
P4SMAJ17CA-AU	BI	400	17	18.9	20.9	1	1	27.6	14.5	
P4SMA20CA-AU	BI	400	17.1	19	21	1	1	27.7	15	
P4SMAJ18CA-AU	BI	400	18	20	22.1	1	1	29.2	13.7	
P4SMA22CA-AU	BI	400	18.8	20.9	23.1	1	1	30.6	14	
P4SMAJ20CA-AU	BI	400	20	22.2	24.5	1	1	32.4	12.3	
P4SMA24CA-AU	BI	400	20.5	22.8	25.2	1	1	33.2	13	
P4SMAJ22CA-AU	BI	400	22	24.4	26.9	1	1	35.5	11.2	
P4SMA27CA-AU	BI	400	23.1	25.7	28.4	1	1	37.5	11.2	
P4SMAJ24CA-AU	BI	400	24	26.7	29.5	1	1	38.9	10.3	
P4SMA30CA-AU	BI	400	25.6	28.5	31.5	1	1	41.4	10	
P4SMAJ26CA-AU	BI	400	26	28.9	31.9	1	1	42.1	9.5	
P4SMAJ28CA-AU	BI	400	28	31.1	34.4	1	1	45.4	8.8	
P4SMA33CA-AU	BI	400	28.2	31.4	34.7	1	1	45.7	9	
P4SMAJ30CA-AU	BI	400	30	33.3	36.8	1	1	48.4	8.3	
P4SMA36CA-AU	BI	400	30.8	34.2	37.8	1	1	49.9	8.4	
P4SMAJ33CA-AU	BI	400	33	36.7	40.6	1	1	53.3	7.5	
P4SMA39CA-AU	BI	400	33.3	37.1	41	1	1	53.9	7.8	
P4SMAJ36CA-AU	BI	400	36	40	44.2	1	1	58.1	6.9	
P4SMA43CA-AU	BI	400	36.8	40.9	45.2	1	1	59.3	7.1	
P4SMAJ40CA-AU	BI	400	40	44.4	49.1	1	1	64.5	6.2	
P4SMA47CA-AU	BI	400	40.2	44.7	49.4	1	1	64.8	5	
P4SMAJ43CA-AU	BI	400	43	47.8	52.8	1	1	69.4	5.7	
P4SMA51CA-AU	BI	400	43.6	48.5	53.6	1	1	70.1	6	
P4SMAJ45CA-AU	BI	400	45	50	55.3	1	1	72.7	5.5	
P4SMA56CA-AU	BI	400	47.8	53.2	58.8	1	1	77	5.5	
P4SMAJ48CA-AU	BI	400	48	53.3	58.9	1	1	77.4	5.2	
P4SMAJ51CA-AU	BI	400	51	56.7	62.7	1	1	82.4	4.9	
P4SMA62CA-AU	BI	400	53	58.9	65.1	1	1	85	5	
P4SMAJ54CA-AU	BI	400	54	60	66.3	1	1	87.1	4.6	
P4SMAJ58CA-AU	BI	400	58	64.4	71.2	1	1	93.6	4.3	
P4SMA68CA-AU	BI	400	58.1	64.6	71.4	1	1	92	4.6	
P4SMAJ60CA-AU	BI	400	60	66.7	73.7	1	1	96.8	4.1	
P4SMAJ64CA-AU	BI	400	64	71.1	78.6	1	1	103	3.9	
P4SMA75CA-AU	BI	400	64.1	71.3	78.8	1	1	103	4.1	
P4SMAJ70CA-AU	BI	400	70	77.8	86	1	1	113	3.5	
P4SMA82CA-AU	BI	400	70.1	77.9	86.1	1	1	113	3.7	

Transient Voltage Suppressors

Part Number	UNI/BI	P _D	V _{RWM}	V _{BR} @ I _T		I _T	I _R @ V _{RWM}	V _C @ I _{PP}	I _{PP}	Package
		W	V	Min.	Max.	mA	μA	Max. V	A	
P4SMAJ8.5A-AU	UNI	400	8.5	9.44	10.4	1	10	14.4	27.7	SMA
P4SMA10A-AU	UNI	400	8.55	9.5	10.5	1	10	14.5	29	
P4SMAJ9.0A-AU	UNI	400	9	10	11.1	1	5	15.4	26	
P4SMA11A-AU	UNI	400	9.4	10.5	11.6	1	5	15.6	27	
P4SMAJ10A-AU	UNI	400	10	11.1	12.3	1	5	17	23.5	
P4SMA12A-AU	UNI	400	10.2	11.4	12.6	1	1	16.7	25	
P4SMAJ11A-AU	UNI	400	11	12.2	13.5	1	1	18.2	22	
P4SMA13A-AU	UNI	400	11.1	12.4	13.7	1	1	18.2	23	
P4SMAJ12A-AU	UNI	400	12	13.3	14.7	1	1	19.9	20.1	
P4SMA15A-AU	UNI	400	12.8	14.3	15.8	1	1	21.2	20	
P4SMAJ13A-AU	UNI	400	13	14.4	15.9	1	1	21.5	18.6	
P4SMA16A-AU	UNI	400	13.6	15.2	16.8	1	1	22.5	19	
P4SMAJ14A-AU	UNI	400	14	15.6	17.2	1	1	23.2	17.2	
P4SMAJ15A-AU	UNI	400	15	16.7	18.5	1	1	24.4	16.4	
P4SMA18A-AU	UNI	400	15.3	17.1	18.9	1	1	25.2	17	
P4SMAJ16A-AU	UNI	400	16	17.8	19.7	1	1	26	15.3	
P4SMAJ17A-AU	UNI	400	17	18.9	20.9	1	1	27.6	14.5	
P4SMA20A-AU	UNI	400	17.1	19	21	1	1	27.7	15	
P4SMAJ18A-AU	UNI	400	18	20	22.1	1	1	29.2	13.7	
P4SMA22A-AU	UNI	400	18.8	20.9	23.1	1	1	30.6	14	
P4SMAJ20A-AU	UNI	400	20	22.2	24.5	1	1	32.4	12.3	
P4SMA24A-AU	UNI	400	20.5	22.8	25.2	1	1	33.2	13	
P4SMAJ22A-AU	UNI	400	22	24.4	26.9	1	1	35.5	11.2	
P4SMA27A-AU	UNI	400	23.1	25.7	28.4	1	1	37.5	11.2	
P4SMAJ24A-AU	UNI	400	24	26.7	29.5	1	1	38.9	10.3	
P4SMA30A-AU	UNI	400	25.6	28.5	31.5	1	1	41.4	10	
P4SMAJ26A-AU	UNI	400	26	28.9	31.9	1	1	42.1	9.5	
P4SMAJ28A-AU	UNI	400	28	31.1	34.4	1	1	45.4	8.8	
P4SMA33A-AU	UNI	400	28.2	31.4	34.7	1	1	45.7	9	
P4SMAJ30A-AU	UNI	400	30	33.3	36.8	1	1	48.4	8.3	
P4SMA36A-AU	UNI	400	30.8	34.2	37.8	1	1	49.9	8.4	
P4SMAJ33A-AU	UNI	400	33	36.7	40.6	1	1	53.3	7.5	
P4SMA39A-AU	UNI	400	33.3	37.1	41	1	1	53.9	7.8	
P4SMAJ36A-AU	UNI	400	36	40	44.2	1	1	58.1	6.9	
P4SMA43A-AU	UNI	400	36.8	40.9	45.2	1	1	59.3	7.1	
P4SMAJ40A-AU	UNI	400	40	44.4	49.1	1	1	64.5	6.2	
P4SMA47A-AU	UNI	400	40.2	44.7	49.4	1	1	64.8	5	
P4SMAJ43A-AU	UNI	400	43	47.8	52.8	1	1	69.4	5.7	
P4SMA51A-AU	UNI	400	43.6	48.5	53.6	1	1	70.1	6	
P4SMAJ45A-AU	UNI	400	45	50	55.3	1	1	72.7	5.5	
P4SMA56A-AU	UNI	400	47.8	53.2	58.8	1	1	77	5.5	
P4SMAJ48A-AU	UNI	400	48	53.3	58.9	1	1	77.4	5.2	
P4SMAJ51A-AU	UNI	400	51	56.7	62.7	1	1	82.4	4.9	
P4SMA62A-AU	UNI	400	53	58.9	65.1	1	1	85	5	
P4SMAJ54A-AU	UNI	400	54	60	66.3	1	1	87.1	4.6	
P4SMAJ58A-AU	UNI	400	58	64.4	71.2	1	1	93.6	4.3	
P4SMA68A-AU	UNI	400	58.1	64.6	71.4	1	1	92	4.6	
P4SMAJ60A-AU	UNI	400	60	66.7	73.7	1	1	96.8	4.1	
P4SMAJ64A-AU	UNI	400	64	71.1	78.6	1	1	103	3.9	
P4SMA75A-AU	UNI	400	64.1	71.3	78.8	1	1	103	4.1	
P4SMAJ70A-AU	UNI	400	70	77.8	86	1	1	113	3.5	
P4SMA82A-AU	UNI	400	70.1	77.9	86.1	1	1	113	3.7	

Transient Voltage Suppressors

Part Number	UNI/BI	P _D	V _{RWM}	V _{BR} @ I _T		I _T	I _R @ V _{RWM}	V _C @ I _{PP}	I _{PP}	Package
		W	V	Min.	Max.	mA	μA	Max. V	A	
P6SMBJ8.5CA-AU	BI	600	8.5	9.44	10.4	1	20	14.4	41.7	SMB
P6SMB10CA-AU	BI	600	8.55	9.5	10.5	1	20	14.5	41	
P6SMBJ9.0CA-AU	BI	600	9	10	11.1	1	5	15.4	39	
P6SMB11CA-AU	BI	600	9.4	10.5	11.6	1	10	15.6	38	
P6SMBJ10CA-AU	BI	600	10	11.1	12.3	1	5	17	35.3	
P6SMB12CA-AU	BI	600	10.2	11.4	12.6	1	5	16.7	36	
P6SMBJ11CA-AU	BI	600	11	12.2	13.5	1	1	18.2	33	
P6SMB13CA-AU	BI	600	11.1	12.4	13.7	1	1	18.2	33	
P6SMBJ12CA-AU	BI	600	12	13.3	14.7	1	1	19.9	30.2	
P6SMB15CA-AU	BI	600	12.8	14.3	15.8	1	1	21.2	28	
P6SMBJ13CA-AU	BI	600	13	14.4	15.9	1	1	21.5	27.9	
P6SMB16CA-AU	BI	600	13.6	15.2	16.8	1	1	22.5	27	
P6SMBJ14CA-AU	BI	600	14	15.6	17.2	1	1	23.2	25.8	
P6SMBJ15CA-AU	BI	600	15	16.7	18.5	1	1	24.4	24	
P6SMB18CA-AU	BI	600	15.3	17.1	18.9	1	1	25.2	24	
P6SMBJ16CA-AU	BI	600	16	17.8	19.7	1	1	26	23.1	
P6SMBJ17CA-AU	BI	600	17	18.9	20.9	1	1	27.6	21.7	
P6SMB20CA-AU	BI	600	17.1	19	21	1	1	27.7	22	
P6SMBJ18CA-AU	BI	600	18	20	22.1	1	1	29.2	20.5	
P6SMB22CA-AU	BI	600	18.8	20.9	23.1	1	1	30.6	20	
P6SMBJ20CA-AU	BI	600	20	22.2	24.5	1	1	32.4	18.5	
P6SMB24CA-AU	BI	600	20.5	22.8	25.2	1	1	33.2	18	
P6SMBJ22CA-AU	BI	600	22	24.4	27	1	1	35.5	16.9	
P6SMB27CA-AU	BI	600	23.1	25.7	28.4	1	1	37.5	16	
P6SMBJ24CA-AU	BI	600	24	26.7	29.5	1	1	38.9	15.4	
P6SMB30CA-AU	BI	600	25.6	28.5	31.5	1	1	41.4	14.4	
P6SMBJ26CA-AU	BI	600	26	28.9	31.9	1	1	42.1	14.2	
P6SMBJ28CA-AU	BI	600	28	31.1	34.4	1	1	45.4	13.2	
P6SMB33CA-AU	BI	600	28.2	31.4	34.7	1	1	45.7	13.2	
P6SMBJ30CA-AU	BI	600	30	33.3	36.8	1	1	48.4	12.4	
P6SMB36CA-AU	BI	600	30.8	34.2	37.8	1	1	49.9	12	
P6SMBJ33CA-AU	BI	600	33	36.7	40.6	1	1	53.3	11.3	
P6SMB39CA-AU	BI	600	33.3	37.1	41	1	1	53.9	11.2	
P6SMBJ36CA-AU	BI	600	36	40	44.2	1	1	58.1	10.3	
P6SMB43CA-AU	BI	600	36.8	40.9	45.2	1	1	59.3	10.1	
P6SMBJ40CA-AU	BI	600	40	44.4	49.1	1	1	64.5	9.3	
P6SMB47CA-AU	BI	600	40.2	44.7	49.4	1	1	64.8	9.3	
P6SMBJ43CA-AU	BI	600	43	47.8	52.8	1	1	69.4	8.6	
P6SMB51CA-AU	BI	600	43.6	48.5	53.6	1	1	70.1	8.6	
P6SMBJ45CA-AU	BI	600	45	50	55.3	1	1	72.7	8.3	
P6SMB56CA-AU	BI	600	47.8	53.2	58.8	1	1	77	7.8	
P6SMBJ48CA-AU	BI	600	48	53.3	58.9	1	1	77.4	7.7	
P6SMBJ51CA-AU	BI	600	51	56.7	62.7	1	1	82.4	7.3	
P6SMB62CA-AU	BI	600	53	58.9	65.1	1	1	85	7.1	
P6SMBJ54CA-AU	BI	600	54	60	66.3	1	1	87.1	6.9	
P6SMBJ58CA-AU	BI	600	58	64.4	71.2	1	1	93.6	6.4	
P6SMB68CA-AU	BI	600	58.1	64.6	71.4	1	1	92	6.5	
P6SMBJ60CA-AU	BI	600	60	66.7	73.7	1	1	96.8	6.2	
P6SMBJ64CA-AU	BI	600	64	71.1	78.6	1	1	103	5.8	
P6SMB75CA-AU	BI	600	64.1	71.3	78.8	1	1	103	5.8	
P6SMBJ70CA-AU	BI	600	70	77.8	86	1	1	113	5.3	
P6SMB82CA-AU	BI	600	70.1	77.9	86.1	1	1	113	5.3	

Transient Voltage Suppressors

Part Number	UNI/BI	P _D	V _{RWM}	V _{BR} @ I _T		I _T	I _R @ V _{RWM}	V _C @ I _{PP}	I _{PP}	Package
		W	V	Min.	Max.	mA	μA	Max. V	A	
P6SMBJ8.5A-AU	UNI	600	8.5	9.44	10.4	1	10	14.4	41.7	SMB
P6SMB10A-AU	UNI	600	8.55	9.5	10.5	1	10	14.5	41	
P6SMBJ9.0A-AU	UNI	600	9	10	11.1	1	5	15.4	39	
P6SMB11A-AU	UNI	600	9.4	10.5	11.6	1	5	15.6	38	
P6SMBJ10A-AU	UNI	600	10	11.1	12.3	1	5	17	35.3	
P6SMB12A-AU	UNI	600	10.2	11.4	12.6	1	5	16.7	36	
P6SMBJ11A-AU	UNI	600	11	12.2	13.5	1	1	18.2	33	
P6SMB13A-AU	UNI	600	11.1	12.4	13.7	1	1	18.2	33	
P6SMBJ12A-AU	UNI	600	12	13.3	14.7	1	1	19.9	30.2	
P6SMB15A-AU	UNI	600	12.8	14.3	15.8	1	1	21.2	28	
P6SMBJ13A-AU	UNI	600	13	14.4	15.9	1	1	21.5	27.9	
P6SMB16A-AU	UNI	600	13.6	15.2	16.8	1	1	22.5	27	
P6SMBJ14A-AU	UNI	600	14	15.6	17.2	1	1	23.2	25.8	
P6SMBJ15A-AU	UNI	600	15	16.7	18.5	1	1	24.4	24	
P6SMB18A-AU	UNI	600	15.3	17.1	18.9	1	1	25.2	24	
P6SMBJ16A-AU	UNI	600	16	17.8	19.7	1	1	26	23.1	
P6SMBJ17A-AU	UNI	600	17	18.9	20.9	1	1	27.6	21.7	
P6SMB20A-AU	UNI	600	17.1	19	21	1	1	27.7	22	
P6SMBJ18A-AU	UNI	600	18	20	22.1	1	1	29.2	20.5	
P6SMB22A-AU	UNI	600	18.8	20.9	23.1	1	1	30.6	20	
P6SMBJ20A-AU	UNI	600	20	22.2	24.5	1	1	32.4	18.5	
P6SMB24A-AU	UNI	600	20.5	22.8	25.2	1	1	33.2	18	
P6SMBJ22A-AU	UNI	600	22	24.4	27	1	1	35.5	16.9	
P6SMB27A-AU	UNI	600	23.1	25.7	28.4	1	1	37.5	16	
P6SMBJ24A-AU	UNI	600	24	26.7	29.5	1	1	38.9	15.4	
P6SMB30A-AU	UNI	600	25.6	28.5	31.5	1	1	41.4	14.4	
P6SMBJ26A-AU	UNI	600	26	28.9	31.9	1	1	42.1	14.2	
P6SMBJ28A-AU	UNI	600	28	31.1	34.4	1	1	45.4	13.2	
P6SMB33A-AU	UNI	600	28.2	31.4	34.7	1	1	45.7	13.2	
P6SMBJ30A-AU	UNI	600	30	33.3	36.8	1	1	48.4	12.4	
P6SMB36A-AU	UNI	600	30.8	34.2	37.8	1	1	49.9	12	
P6SMBJ33A-AU	UNI	600	33	36.7	40.6	1	1	53.3	11.3	
P6SMB39A-AU	UNI	600	33.3	37.1	41	1	1	53.9	11.2	
P6SMBJ36A-AU	UNI	600	36	40	44.2	1	1	58.1	10.3	
P6SMB43A-AU	UNI	600	36.8	40.9	45.2	1	1	59.3	10.1	
P6SMBJ40A-AU	UNI	600	40	44.4	49.1	1	1	64.5	9.3	
P6SMB47A-AU	UNI	600	40.2	44.7	49.4	1	1	64.8	9.3	
P6SMBJ43A-AU	UNI	600	43	47.8	52.8	1	1	69.4	8.6	
P6SMB51A-AU	UNI	600	43.6	48.5	53.6	1	1	70.1	8.6	
P6SMBJ45A-AU	UNI	600	45	50	55.3	1	1	72.7	8.3	
P6SMB56A-AU	UNI	600	47.8	53.2	58.8	1	1	77	7.8	
P6SMBJ48A-AU	UNI	600	48	53.3	58.9	1	1	77.4	7.7	
P6SMBJ51A-AU	UNI	600	51	56.7	62.7	1	1	82.4	7.3	
P6SMB62A-AU	UNI	600	53	58.9	65.1	1	1	85	7.1	
P6SMBJ54A-AU	UNI	600	54	60	66.3	1	1	87.1	6.9	
P6SMBJ58A-AU	UNI	600	58	64.4	71.2	1	1	93.6	6.4	
P6SMB68A-AU	UNI	600	58.1	64.6	71.4	1	1	92	6.5	
P6SMBJ60A-AU	UNI	600	60	66.7	73.7	1	1	96.8	6.2	
P6SMBJ64A-AU	UNI	600	64	71.1	78.6	1	1	103	5.8	
P6SMB75A-AU	UNI	600	64.1	71.3	78.8	1	1	103	5.8	
P6SMBJ70A-AU	UNI	600	70	77.8	86	1	1	113	5.3	
P6SMB82A-AU	UNI	600	70.1	77.9	86.1	1	1	113	5.3	

Transient Voltage Suppressors

Part Number	UNI/BI	P _D	V _{RWM}	V _{BR} @ I _T		I _T	I _R @ V _{RWM}	V _C @ I _{PP}	I _{PP}	Package
		W	V	Min.	Max.	mA	μA	Max. V	A	
1.5SMCJ8.5CA-AU	BI	1500	8.5	9.44	10.82	1	50	14.4	104.2	SMC
1.5SMC10CA-AU	BI	1500	8.55	9.5	10.5	1	20	14.5	103	
1.5SMCJ9.0CA-AU	BI	1500	9	10	11.5	1	20	15.4	97.4	
1.5SMC11CA-AU	BI	1500	9.4	10.5	11.6	1	10	15.6	96	
1.5SMCJ10CA-AU	BI	1500	10	11.1	12.8	1	5	17	88.2	
1.5SMC12CA-AU	BI	1500	10.2	11.4	12.6	1	5	16.7	90	
1.5SMCJ11CA-AU	BI	1500	11	12.2	14	1	1	18.2	82.4	
1.5SMC13CA-AU	BI	1500	11.1	12.4	13.7	1	1	18.2	82	
1.5SMCJ12CA-AU	BI	1500	12	13.3	15.3	1	1	19.9	75.3	
1.5SMC15CA-AU	BI	1500	12.8	14.3	15.8	1	1	21.2	71	
1.5SMCJ13CA-AU	BI	1500	13	14.4	16.5	1	1	21.5	69.7	
1.5SMC16CA-AU	BI	1500	13.6	15.2	16.8	1	1	22.5	67	
1.5SMCJ14CA-AU	BI	1500	14	15.6	17.9	1	1	23.2	64.7	
1.5SMCJ15CA-AU	BI	1500	15	16.7	19.2	1	1	24.4	61.5	
1.5SMC18CA-AU	BI	1500	15.3	17.1	18.9	1	1	25.2	59.5	
1.5SMCJ16CA-AU	BI	1500	16	17.8	20.5	1	1	26	57.7	
1.5SMCJ17CA-AU	BI	1500	17	18.9	21.7	1	1	27.6	53.3	
1.5SMC20CA-AU	BI	1500	17.1	19	21	1	1	27.7	54	
1.5SMCJ18CA-AU	BI	1500	18	20	23.3	1	1	29.2	51.4	
1.5SMC22CA-AU	BI	1500	18.8	20.9	23.1	1	1	30.6	49	
1.5SMCJ20CA-AU	BI	1500	20	22.2	25.5	1	1	32.4	46.3	
1.5SMC24CA-AU	BI	1500	20.5	22.8	25.2	1	1	33.2	45	
1.5SMCJ22CA-AU	BI	1500	22	24.4	28	1	1	35.5	42.2	
1.5SMC27CA-AU	BI	1500	23.1	25.7	28.4	1	1	37.5	40	
1.5SMCJ24CA-AU	BI	1500	24	26.7	30.7	1	1	38.9	38.6	
1.5SMC30CA-AU	BI	1500	25.6	28.5	31.5	1	1	41.4	36	
1.5SMCJ26CA-AU	BI	1500	26	28.9	33.2	1	1	42.1	35.6	
1.5SMCJ28CA-AU	BI	1500	28	31.1	35.8	1	1	45.4	33	
1.5SMC33CA-AU	BI	1500	28.2	31.4	34.7	1	1	45.7	33	
1.5SMCJ30CA-AU	BI	1500	30	33.3	38.3	1	1	48.4	31	
1.5SMC36CA-AU	BI	1500	30.8	34.2	37.8	1	1	49.9	30	
1.5SMCJ33CA-AU	BI	1500	33	36.7	42.2	1	1	53.3	28.1	
1.5SMC39CA-AU	BI	1500	33.3	37.1	41	1	1	53.9	28	
1.5SMCJ36CA-AU	BI	1500	36	40	46	1	1	58.1	25.8	
1.5SMC43CA-AU	BI	1500	36.8	40.9	45.2	1	1	59.3	25.3	
1.5SMCJ40CA-AU	BI	1500	40	44.4	51.1	1	1	64.5	23.2	
1.5SMC47CA-AU	BI	1500	40.2	44.7	49.4	1	1	64.8	23.2	
1.5SMCJ43CA-AU	BI	1500	43	47.8	55	1	1	69.4	21.6	
1.5SMC51CA-AU	BI	1500	43.6	48.5	53.6	1	1	70.1	21.4	
1.5SMCJ45CA-AU	BI	1500	45	50	57.5	1	1	72.7	20.6	
1.5SMC56CA-AU	BI	1500	47.8	53.2	58.8	1	1	77	19.5	
1.5SMCJ48CA-AU	BI	1500	48	53.3	61.3	1	1	77.4	19.4	
1.5SMCJ51CA-AU	BI	1500	51	56.7	65.2	1	1	82.4	18.2	
1.5SMC62CA-AU	BI	1500	53	58.9	65.1	1	1	85	17.7	
1.5SMCJ54CA-AU	BI	1500	54	60	69	1	1	87.1	17.2	
1.5SMCJ58CA-AU	BI	1500	58	64.4	74.1	1	1	93.6	16	
1.5SMC68CA-AU	BI	1500	58.1	64.6	71.4	1	1	92	16.3	
1.5SMCJ60CA-AU	BI	1500	60	66.7	76.7	1	1	96.8	15.5	
1.5SMCJ64CA-AU	BI	1500	64	71.1	81.8	1	1	103	14.6	

Transient Voltage Suppressors

Part Number	UNI/BI	P _D	V _{RWM}	V _{BR} @ I _T		I _T	I _R @ V _{RWM}	V _C @ I _{PP}	I _{PP}	Package
		W	V	Min.	Max.	mA	(μ A)	Max.	A	
1.5SMC75CA-AU	BI	1500	64.1	71.3	78.8	1	1	103	14.6	SMC
1.5SMCJ70CA-AU	BI	1500	70	77.8	89.5	1	1	113	13.3	
3.0SMCJ10CA-AU	BI	3000	10	11.1	12.8	1	3	17	176.4	
3.0SMCJ11CA-AU	BI	3000	11	12.2	14	1	3	18.2	184.8	
3.0SMCJ12CA-AU	BI	3000	12	13.3	15.3	1	3	19.9	150.6	
3.0SMCJ13CA-AU	BI	3000	13	14.4	16.5	1	3	21.5	139.4	
3.0SMCJ14CA-AU	BI	3000	14	15.6	17.9	1	3	23.2	129.4	
3.0SMCJ15CA-AU	BI	3000	15	16.7	19.2	1	3	24.4	123	
3.0SMCJ16CA-AU	BI	3000	16	17.8	20.5	1	3	26	115.4	
3.0SMCJ17CA-AU	BI	3000	17	18.9	21.7	1	3	27.6	106.6	
3.0SMCJ18CA-AU	BI	3000	18	20	23.3	1	3	29.2	102.8	
3.0SMCJ20CA-AU	BI	3000	20	22.2	25.5	1	3	32.4	92.6	
3.0SMCJ22CA-AU	BI	3000	22	24.4	28	1	3	35.5	84.4	
3.0SMCJ24CA-AU	BI	3000	24	26.7	30.7	1	3	38.9	77.2	
3.0SMCJ26CA-AU	BI	3000	26	28.9	33.2	1	3	42.1	71.2	
3.0SMCJ28CA-AU	BI	3000	28	31.1	35.8	1	3	45.4	66	
3.0SMCJ30CA-AU	BI	3000	30	33.3	38.3	1	3	48.4	62	
3.0SMCJ33CA-AU	BI	3000	33	36.7	42.2	1	3	53.3	56.2	
3.0SMCJ36CA-AU	BI	3000	36	40	46	1	3	58.1	51.6	
3.0SMCJ40CA-AU	BI	3000	40	44.4	51.1	1	3	64.5	46.4	
3.0SMCJ43CA-AU	BI	3000	43	47.8	54.9	1	3	69.4	43.2	
3.0SMCJ45CA-AU	BI	3000	45	50	57.5	1	3	72.7	41.2	
3.0SMCJ48CA-AU	BI	3000	48	53.3	61.3	1	3	77.4	38.8	
3.0SMCJ51CA-AU	BI	3000	51	56.7	65.2	1	3	82.4	36.4	
3.0SMCJ54CA-AU	BI	3000	54	60	69	1	3	87.1	34.4	
3.0SMCJ58CA-AU	BI	3000	58	64.4	74.1	1	3	93.6	32	
3.0SMCJ60CA-AU	BI	3000	60	66.7	76.7	1	3	96.8	31	
3.0SMCJ64CA-AU	BI	3000	64	71.1	81.8	1	3	103	29.2	
3.0SMCJ70CA-AU	BI	3000	70	77.8	89.5	1	3	113	26.6	
5KMC12CAS-AU	BI	5000	12	13.3	14.7	10	5	19.9	252	
5KMC13CAS-AU	BI	5000	13	14.4	15.9	10	5	21.5	233	
5KMC14CAS-AU	BI	5000	14	15.6	17.2	10	5	23.2	216	
5KMC15CAS-AU	BI	5000	15	16.7	18.5	1	5	24.4	205	
5KMC16CAS-AU	BI	5000	16	17.8	19.7	1	5	26	193	
5KMC17CAS-AU	BI	5000	17	18.9	20.9	1	5	27.6	181	
5KMC18CAS-AU	BI	5000	18	20	22.1	1	5	29.2	172	
5KMC20CAS-AU	BI	5000	20	22.2	24.5	1	5	32.4	155	
5KMC22CAS-AU	BI	5000	22	24.4	26.9	1	5	35.5	141	
5KMC24CAS-AU	BI	5000	24	26.7	29.5	1	5	38.9	129	
5KMC26CAS-AU	BI	5000	26	28.9	31.9	1	5	42.1	119	
5KMC28CAS-AU	BI	5000	28	31.1	34.4	1	5	45.4	110	
5KMC30CAS-AU	BI	5000	30	33.3	36.8	1	5	48.4	103	
5KMC33CAS-AU	BI	5000	33	36.7	40.6	1	5	53.3	93.9	
5KMC36CAS-AU	BI	5000	36	40	44.2	1	5	58.1	86.1	
1.5SMCJ8.5A-AU	UNI	1500	8.5	9.44	10.82	1	25	14.4	104.2	
1.5SMC10A-AU	UNI	1500	8.55	9.5	10.5	1	10	14.5	103	
1.5SMCJ9.0A-AU	UNI	1500	9	10	11.5	1	10	15.4	97.4	
1.5SMC11A-AU	UNI	1500	9.4	10.5	11.6	1	5	15.6	96	
1.5SMCJ10A-AU	UNI	1500	10	11.1	12.8	1	5	17	88.2	

Transient Voltage Suppressors

Part Number	UNI/BI	P _D	V _{RWM}	V _{BR} @ I _T		I _T	I _R @ V _{RWM}	V _C @ I _{PP}	I _{PP}	Package
		W	V	Min.	Max.	mA	μA	Max. V	A	
1.5SMC12A-AU	UNI	1500	10.2	11.4	12.6	1	5	16.7	90	SMC
1.5SMCJ11A-AU	UNI	1500	11	12.2	14	1	1	18.2	82.4	
1.5SMC13A-AU	UNI	1500	11.1	12.4	13.7	1	1	18.2	82	
1.5SMCJ12A-AU	UNI	1500	12	13.3	15.3	1	1	19.9	75.3	
1.5SMC15A-AU	UNI	1500	12.8	14.3	15.8	1	1	21.2	71	
1.5SMCJ13A-AU	UNI	1500	13	14.4	16.5	1	1	21.5	69.7	
1.5SMC16A-AU	UNI	1500	13.6	15.2	16.8	1	1	22.5	67	
1.5SMCJ14A-AU	UNI	1500	14	15.6	17.9	1	1	23.2	64.7	
1.5SMCJ15A-AU	UNI	1500	15	16.7	19.2	1	1	24.4	61.5	
1.5SMC18A-AU	UNI	1500	15.3	17.1	18.9	1	1	25.2	59.5	
1.5SMCJ16A-AU	UNI	1500	16	17.8	20.5	1	1	26	57.7	
1.5SMCJ17A-AU	UNI	1500	17	18.9	21.7	1	1	27.6	53.3	
1.5SMC20A-AU	UNI	1500	17.1	19	21	1	1	27.7	54	
1.5SMCJ18A-AU	UNI	1500	18	20	23.3	1	1	29.2	51.4	
1.5SMC22A-AU	UNI	1500	18.8	20.9	23.1	1	1	30.6	49	
1.5SMCJ20A-AU	UNI	1500	20	22.2	25.5	1	1	32.4	46.3	
1.5SMC24A-AU	UNI	1500	20.5	22.8	25.2	1	1	33.2	45	
1.5SMCJ22A-AU	UNI	1500	22	24.4	28	1	1	35.5	42.2	
1.5SMC27A-AU	UNI	1500	23.1	25.7	28.4	1	1	37.5	40	
1.5SMCJ24A-AU	UNI	1500	24	26.7	30.7	1	1	38.9	38.6	
1.5SMC30A-AU	UNI	1500	25.6	28.5	31.5	1	1	41.4	36	
1.5SMCJ26A-AU	UNI	1500	26	28.9	33.2	1	1	42.1	35.6	
1.5SMCJ28A-AU	UNI	1500	28	31.1	35.8	1	1	45.4	33	
1.5SMC33A-AU	UNI	1500	28.2	31.4	34.7	1	1	45.7	33	
1.5SMCJ30A-AU	UNI	1500	30	33.3	38.3	1	1	48.4	31	
1.5SMC36A-AU	UNI	1500	30.8	34.2	37.8	1	1	49.9	30	
1.5SMCJ33A-AU	UNI	1500	33	36.7	42.2	1	1	53.3	28.1	
1.5SMC39A-AU	UNI	1500	33.3	37.1	41	1	1	53.9	28	
1.5SMCJ36A-AU	UNI	1500	36	40	46	1	1	58.1	25.8	
1.5SMC43A-AU	UNI	1500	36.8	40.9	45.2	1	1	59.3	25.3	
1.5SMCJ40A-AU	UNI	1500	40	44.4	51.1	1	1	64.5	23.2	
1.5SMC47A-AU	UNI	1500	40.2	44.7	49.4	1	1	64.8	23.2	
1.5SMCJ43A-AU	UNI	1500	43	47.8	55	1	1	69.4	21.6	
1.5SMC51A-AU	UNI	1500	43.6	48.5	53.6	1	1	70.1	21.4	
1.5SMCJ45A-AU	UNI	1500	45	50	57.5	1	1	72.7	20.6	
1.5SMC56A-AU	UNI	1500	47.8	53.2	58.8	1	1	77	19.5	
1.5SMCJ48A-AU	UNI	1500	48	53.3	61.3	1	1	77.4	19.4	
1.5SMCJ51A-AU	UNI	1500	51	56.7	65.2	1	1	82.4	18.2	
1.5SMC62A-AU	UNI	1500	53	58.9	65.1	1	1	85	17.7	
1.5SMCJ54A-AU	UNI	1500	54	60	69	1	1	87.1	17.2	
1.5SMCJ58A-AU	UNI	1500	58	64.4	74.1	1	1	93.6	16	
1.5SMC68A-AU	UNI	1500	58.1	64.6	71.4	1	1	92	16.3	
1.5SMCJ60A-AU	UNI	1500	60	66.7	76.7	1	1	96.8	15.5	
1.5SMCJ64A-AU	UNI	1500	64	71.1	81.8	1	1	103	14.6	
1.5SMC75A-AU	UNI	1500	64.1	71.3	78.8	1	1	103	14.6	
1.5SMCJ70A-AU	UNI	1500	70	77.8	89.5	1	1	113	13.3	
3.0SMCJ10A-AU	UNI	3000	10	11.1	12.8	1	3	17	176.4	
3.0SMCJ11A-AU	UNI	3000	11	12.2	14	1	3	18.2	184.8	
3.0SMCJ12A-AU	UNI	3000	12	13.3	15.3	1	3	19.9	150.6	

Transient Voltage Suppressors

Part Number	UNI/BI	P _D	V _{RWM}	V _{BR} @ I _T (V)		I _T	I _R @ V _{RWM} (μA)	V _C @ I _{PP} Max.	I _{PP}	Package
		W	V	Min.	Max.	mA	μA	V	A	
3.0SMCJ13A-AU	UNI	3000	13	14.4	16.5	1	3	21.5	139.4	SMC
3.0SMCJ14A-AU	UNI	3000	14	15.6	17.9	1	3	23.2	129.4	
3.0SMCJ15A-AU	UNI	3000	15	16.7	19.2	1	3	24.4	123	
3.0SMCJ16A-AU	UNI	3000	16	17.8	20.5	1	3	26	115.4	
3.0SMCJ17A-AU	UNI	3000	17	18.9	21.7	1	3	27.6	106.6	
3.0SMCJ18A-AU	UNI	3000	18	20	23.3	1	3	29.2	102.8	
3.0SMCJ20A-AU	UNI	3000	20	22.2	25.5	1	3	32.4	92.6	
3.0SMCJ22A-AU	UNI	3000	22	24.4	28	1	3	35.5	84.4	
3.0SMCJ24A-AU	UNI	3000	24	26.7	30.7	1	3	38.9	77.2	
3.0SMCJ26A-AU	UNI	3000	26	28.9	33.2	1	3	42.1	71.2	
3.0SMCJ28A-AU	UNI	3000	28	31.1	35.8	1	3	45.4	66	
3.0SMCJ30A-AU	UNI	3000	30	33.3	38.3	1	3	48.4	62	
3.0SMCJ33A-AU	UNI	3000	33	36.7	42.2	1	3	53.3	56.2	
3.0SMCJ36A-AU	UNI	3000	36	40	46	1	3	58.1	51.6	
3.0SMCJ40A-AU	UNI	3000	40	44.4	51.1	1	3	64.5	46.4	
3.0SMCJ43A-AU	UNI	3000	43	47.8	54.9	1	3	69.4	43.2	
3.0SMCJ45A-AU	UNI	3000	45	50	57.5	1	3	72.7	41.2	
3.0SMCJ48A-AU	UNI	3000	48	53.3	61.3	1	3	77.4	38.8	
3.0SMCJ51A-AU	UNI	3000	51	56.7	65.2	1	3	82.4	36.4	
3.0SMCJ54A-AU	UNI	3000	54	60	69	1	3	87.1	34.4	
3.0SMCJ58A-AU	UNI	3000	58	64.4	74.1	1	3	93.6	32	
3.0SMCJ60A-AU	UNI	3000	60	66.7	76.7	1	3	96.8	31	
3.0SMCJ64A-AU	UNI	3000	64	71.1	81.8	1	3	103	29.2	
3.0SMCJ70A-AU	UNI	3000	70	77.8	89.5	1	3	113	26.6	
5KMC12AS-AU	UNI	5000	12	13.3	14.7	10	5	19.9	252	
5KMC13AS-AU	UNI	5000	13	14.4	15.9	10	5	21.5	233	
5KMC14AS-AU	UNI	5000	14	15.6	17.2	10	5	23.2	216	
5KMC15AS-AU	UNI	5000	15	16.7	18.5	1	5	24.4	205	
5KMC16AS-AU	UNI	5000	16	17.8	19.7	1	5	26	193	
5KMC17AS-AU	UNI	5000	17	18.9	20.9	1	5	27.6	181	
5KMC18AS-AU	UNI	5000	18	20	22.1	1	5	29.2	172	
5KMC20AS-AU	UNI	5000	20	22.2	24.5	1	5	32.4	155	
5KMC22AS-AU	UNI	5000	22	24.4	26.9	1	5	35.5	141	
5KMC24AS-AU	UNI	5000	24	26.7	29.5	1	5	38.9	129	
5KMC26AS-AU	UNI	5000	26	28.9	31.9	1	5	42.1	119	
5KMC28AS-AU	UNI	5000	28	31.1	34.4	1	5	45.4	110	
5KMC30AS-AU	UNI	5000	30	33.3	36.8	1	5	48.4	103	
5KMC33AS-AU	UNI	5000	33	36.7	40.6	1	5	53.3	93.9	
5KMC36AS-AU	UNI	5000	36	40	44.2	1	5	58.1	86.1	
5KMC40AS-AU	UNI	5000	40	44.4	49.1	1	5	64.5	77.6	
5KMC43AS-AU	UNI	5000	43	47.8	52.8	1	5	69.4	72.1	
5KMC45AS-AU	UNI	5000	45	50	55.3	1	5	72.7	68.8	
5KMC48AS-AU	UNI	5000	48	53.3	58.9	1	5	77.4	64.7	
5KMC51AS-AU	UNI	5000	51	56.7	62.7	1	5	82.4	60.7	
5KMC54AS-AU	UNI	5000	54	60	66.3	1	5	87.1	57.5	
5KMC58AS-AU	UNI	5000	58	64.4	71.2	1	5	93.6	53.5	
5KMC60AS-AU	UNI	5000	60	66.7	73.7	1	5	96.8	51.7	
5KMC64AS-AU	UNI	5000	64	71.1	78.6	1	5	103	48.6	
5KMC70AS-AU	UNI	5000	70	77.8	86	1	5	113	44.3	

Load Dump Transient Voltage Suppressors

Part Number	UNI/BI	P _D	V _{RWM}	V _{BR} @ I _T		I _T	I _R @ V _{RWM}	V _C @ I _{PP}	I _{PP}	Package
		W	V	Min.	Max.	mA	(μA) UNI	Max. V	A	
SM5S14A-AU	UNI	3600	14	15.6	17.2	5	1	23.2	198	DO-218AB
SM5S15A-AU	UNI	3600	15	16.7	18.5	5	1	24.4	189	
SM5S16A-AU	UNI	3600	16	17.8	19.7	5	1	26	177	
SM5S17A-AU	UNI	3600	17	18.9	20.9	5	1	27.6	167	
SM5S18A-AU	UNI	3600	18	20	22.1	5	0.5	29.2	158	
SM5S20A-AU	UNI	3600	20	22.2	24.5	5	0.5	32.4	142	
SM5S22A-AU	UNI	3600	22	24.4	26.9	5	0.5	35.5	130	
SM5S24A-AU	UNI	3600	24	26.7	29.5	5	0.5	38.9	118	
SM5S26A-AU	UNI	3600	26	28.9	31.9	5	0.5	42.1	109	
SM5S28A-AU	UNI	3600	28	31.1	34.4	5	0.5	45.4	101	
SM5S30A-AU	UNI	3600	30	33.3	36.8	5	0.5	48.4	95	
SM5S33A-AU	UNI	3600	33	36.7	40.6	5	0.5	53.3	86	
SM5S36A-AU	UNI	3600	36	40	44.2	5	0.5	58.1	79	
SM5S40A-AU	UNI	3600	40	44.4	49.1	5	0.5	64.5	71	
SM5S43A-AU	UNI	3600	43	47.8	52.8	5	0.5	69.4	66	
SM5S48A-AU	UNI	3600	48	53.3	58.7	5	0.5	80.6	57	
SM6S14A-AU	UNI	4600	14	15.6	17.2	5	1	23.2	198	
SM6S15A-AU	UNI	4600	15	16.7	18.5	5	1	24.4	189	
SM6S16A-AU	UNI	4600	16	17.8	19.7	5	1	26	177	
SM6S17A-AU	UNI	4600	17	18.9	20.9	5	1	27.6	167	
SM6S18A-AU	UNI	4600	18	20	22.1	5	0.5	29.2	158	
SM6S20A-AU	UNI	4600	20	22.2	24.5	5	0.5	32.4	142	
SM6S22A-AU	UNI	4600	22	24.4	26.9	5	0.5	35.5	130	
SM6S24A-AU	UNI	4600	24	26.7	29.5	5	0.5	38.9	118	
SM6S26A-AU	UNI	4600	26	28.9	31.9	5	0.5	42.1	109	
SM6S28A-AU	UNI	4600	28	31.1	34.4	5	0.5	45.4	101	
SM6S30A-AU	UNI	4600	30	33.3	36.8	5	0.5	48.4	95	
SM6S33A-AU	UNI	4600	33	36.7	40.6	5	0.5	53.3	86	
SM6S36A-AU	UNI	4600	36	40	44.2	5	0.5	58.1	79	
SM6S40A-AU	UNI	4600	40	44.4	49.1	5	0.5	64.5	71	
SM6S43A-AU	UNI	4600	43	47.8	52.8	5	0.5	69.4	66	
SM6S48A-AU	UNI	4600	48	53.3	58.7	5	0.5	80.6	57	
SM8S14A-AU	UNI	6600	14	15.6	17.2	5	1	23.2	284	
SM8S15A-AU	UNI	6600	15	16.7	18.5	5	1	24.4	270	
SM8S16A-AU	UNI	6600	16	17.8	19.7	5	1	26	254	
SM8S17A-AU	UNI	6600	17	18.9	20.9	5	1	27.6	239	
SM8S18A-AU	UNI	6600	18	20	22.1	5	0.5	29.2	226	
SM8S20A-AU	UNI	6600	20	22.2	24.5	5	0.5	32.4	204	
SM8S22A-AU	UNI	6600	22	24.4	26.9	5	0.5	35.5	186	
SM8S24A-AU	UNI	6600	24	26.7	29.5	5	0.5	38.9	170	
SM8S26A-AU	UNI	6600	26	28.9	31.9	5	0.5	42.1	157	
SM8S28A-AU	UNI	6600	28	31.1	34.4	5	0.5	45.4	145	
SM8S30A-AU	UNI	6600	30	33.3	36.8	5	0.5	48.4	136	
SM8S33A-AU	UNI	6600	33	36.7	40.6	5	0.5	53.3	124	
SM8S36A-AU	UNI	6600	36	40	44.2	5	0.5	58.1	114	
SM8S40A-AU	UNI	6600	40	44.4	49.1	5	0.5	64.5	102	
SM8S43A-AU	UNI	6600	43	47.8	52.8	5	0.5	69.4	95	
SM8S48A-AU	UNI	6600	48	53.3	58.7	5	0.5	80.6	82	

General Transistors

Part Number	Config.	Type	V _{CB0}	V _{CE0}	I _C	V _{CE(sat)}			h _{FE}				P _{TOT}	ft	Package
			Max.	Max.	Max.	Max.	I _C	I _B	Min.	Max.	V _{CE}	I _C	Max.	Min.	
			V	V	mA	V	I _C (mA)	I _B (mA)			(V)	(mA)	mW	MHz	
MMDT2222ATB6-AU	Dual	NPN+NPN	75	40	600	0.3	150	15	100	300	10	150	200	300	SOT-563
BC848AW-AU	Single	NPN	30	30	100	0.25	10	0.5	110	220	5	2	250	-	SOT-323
BC848BW-AU	Single	NPN	30	30	100	0.25	10	0.5	200	450	5	2	250	-	
BC849BW-AU	Single	NPN	30	30	100	0.25	10	0.5	200	450	5	2	250	-	
BC848CW-AU	Single	NPN	30	30	100	0.25	10	0.5	420	800	5	2	250	-	
BC849CW-AU	Single	NPN	30	30	100	0.25	10	0.5	420	800	5	2	250	-	
BC847AW-AU	Single	NPN	50	45	100	0.25	10	0.5	110	220	5	2	250	-	
BC847BW-AU	Single	NPN	50	45	100	0.25	10	0.5	200	450	5	2	250	-	
BC850BW-AU	Single	NPN	50	45	100	0.25	10	0.5	200	450	5	2	250	-	
BC847CW-AU	Single	NPN	50	45	100	0.25	10	0.5	420	800	5	2	250	-	
BC850CW-AU	Single	NPN	50	45	100	0.25	10	0.5	420	800	5	2	250	-	
BC817-16W-AU	Single	NPN	50	45	500	0.7	500	50	100	250	1	100	300	100	
BC817-25W-AU	Single	NPN	50	45	500	0.7	500	50	160	400	1	100	300	100	
BC817-40W-AU	Single	NPN	50	45	500	0.7	500	50	250	600	1	100	300	100	
BC846AW-AU	Single	NPN	80	65	100	0.25	10	0.5	110	220	5	2	250	-	
BC846BW-AU	Single	NPN	80	65	100	0.25	10	0.5	200	450	5	2	250	-	
MMBT5551W-AU	Single	NPN	180	160	600	0.15	10	10	80	250	5	10	200	100	
BC856BW-AU	Single	PNP	-80	-65	-100	-0.3	-10	-0.5	220	475	-5	-2	250	-	
BC807-16W-AU	Single	PNP	-50	-45	-500	-0.7	-500	-50	100	250	-1	-100	300	100	
BC807-25W-AU	Single	PNP	-50	-45	-500	-0.7	-500	-50	160	400	-1	-100	300	100	
BC807-40W-AU	Single	PNP	-50	-45	-500	-0.7	-500	-50	250	600	-1	-100	300	100	
BC857AW-AU	Single	PNP	-50	-45	-100	-0.3	-10	-0.5	125	250	-5	-2	250	-	
BC857BW-AU	Single	PNP	-50	-45	-100	-0.3	-10	-0.5	220	475	-5	-2	250	-	
BC857CW-AU	Single	PNP	-50	-45	-100	-0.3	-10	-0.5	420	800	-5	-2	250	-	
BC847AS-AU	Dual	NPN+NPN	50	45	100	0.1	10	0.5	110	220	5	2	150	-	SOT-363
BC847BS-AU	Dual	NPN+NPN	50	45	100	0.25	10	0.5	200	450	5	2	150	100	
DMMT3904W-AU	Dual	NPN+NPN	60	40	200	0.3	50	5	100	300	1	10	225	300	
BC846BS-AU	Dual	NPN+NPN	80	65	100	0.1	10	0.5	200	450	5	2	250	-	
BC846AS-AU	Dual	NPN+NPN	80	65	100	0.25	10	0.5	110	220	5	2	150	-	
BC856BS-AU	Dual	PNP+PNP	-80	-65	-100	-0.3	-10	-0.5	220	475	-5	-2	150	100	
BC857BS-AU	Dual	PNP+PNP	-50	-45	-100	-0.3	-10	-0.5	220	475	-5	-2	300	100	
BC857CS-AU	Dual	PNP+PNP	-50	-45	-100	-0.3	-10	-0.5	420	800	-5	-2	225	-	
BC847BPN-AU	Comple.	NPN	50	45	100	0.25	10	0.5	200	450	5	2	200	100	
		PNP	-50	-45	-100	-0.3	-10	-0.5	200	475	-5	-2	200	100	
BC847CPN-AU	Comple.	NPN	50	45	100	0.25	10	0.5	420	800	5	2	380	100	
		PNP	-50	-45	-100	-0.3	-10	-0.5	420	800	-5	-2	380	100	
BC846BPN-AU	Comple.	NPN	80	65	100	0.25	10	0.5	200	450	5	2	225	100	
		PNP	-80	-65	-100	-0.3	-10	-0.5	220	475	-5	-2	225	100	

General Transistors

Part Number	Config.	Type	V _{CB0}	V _{CE0}	I _C	V _{CE(sat)}			h _{FE}				P _{TOT}	ft	Package	
			Max.	Max.	Max.	Max.	I _C	I _B	Min.	Max.	V _{CE}	I _C	Max.	Min.		
			V	V	mA	V	I _C (mA)	I _B (mA)			(V)	(mA)	mW	MHz		
BC848A-AU	Single	NPN	30	30	100	0.25	10	0.5	110	220	5	2	330	-	SOT-23	
BC848B-AU	Single	NPN	30	30	100	0.25	10	0.5	200	450	5	2	330	-		
BC849B-AU	Single	NPN	30	30	100	0.25	10	0.5	200	450	5	2	330	-		
BC848C-AU	Single	NPN	30	30	100	0.25	10	0.5	420	800	5	2	330	-		
BC849C-AU	Single	NPN	30	30	100	0.25	10	0.5	420	800	5	2	330	-		
2SC2411K-AU	Single	NPN	40	32	500	0.6	500	50	120	390	3	100	225	250		
BC847A-AU	Single	NPN	50	45	100	0.25	10	0.5	110	220	5	2	330	-		
BC847B-AU	Single	NPN	50	45	100	0.25	10	0.5	200	450	5	2	330	-		
BC850B-AU	Single	NPN	50	45	100	0.25	10	0.5	200	450	5	2	330	-		
BC847C-AU	Single	NPN	50	45	100	0.25	10	0.5	420	800	5	2	330	-		
BC850C-AU	Single	NPN	50	45	100	0.25	10	0.5	420	800	5	2	330	-		
BC817-16-AU	Single	NPN	50	45	500	0.7	500	50	100	250	1	100	300	100		
BC817-25-AU	Single	NPN	50	45	500	0.7	500	50	160	400	1	100	300	100		
BC817-40-AU	Single	NPN	50	45	500	0.7	500	50	250	600	1	100	300	100		
MMBT3904-AU	Single	NPN	60	40	200	0.3	50	5	100	300	1	10	225	-		
MMBT4401-AU	Single	NPN	60	40	600	0.4	150	15	100	300	1	150	225	250		
MMBTA05-AU	Single	NPN	60	60	500	0.25	100	10	100	-	1	100	225	100		
MMBT2222A-AU	Single	NPN	75	40	600	0.3	150	15	100	300	10	150	225	-		
BC846A-AU	Single	NPN	80	65	100	0.25	10	0.5	110	220	5	2	330	-		
BC846B-AU	Single	NPN	80	65	100	0.25	10	0.5	200	450	5	2	330	-		
MMBTA06-AU	Single	NPN	80	80	500	0.25	100	10	100	-	1	100	225	100		
MMBT5551-AU	Single	NPN	180	160	600	0.15	10	1	80	250	5	10	250	100		
MMBTA42-AU	Single	NPN	300	300	500	0.5	20	2	40	-	10	30	250	50		
MMBTA92-AU	Single	PNP	-300	-300	-500	-0.5	-20	-2	25	-	-10	-30	225	50		
MMBT5401-AU	Single	PNP	-160	-150	-500	-0.5	-50	-5	60	240	-10	-5	225	100		
MMBTA56-AU	Single	PNP	-80	-80	-500	-0.25	-100	-10	100	-	-1	-100	225	100		
BC856A-AU	Single	PNP	-80	-65	-100	-0.3	-10	-0.5	125	250	-5	-2	330	-		
BC856B-AU	Single	PNP	-80	-65	-100	-0.3	-10	-0.5	220	475	-5	-2	330	-		
MMBT2907A-AU	Single	PNP	-60	-60	-600	-0.4	-150	-15	100	300	-10	-150	150	200		
MMBTA55-AU	Single	PNP	-60	-60	-500	-0.25	-100	-10	100	-	-1	-100	225	100		
BC807-16-AU	Single	PNP	-50	-45	-500	-0.7	-500	-50	100	250	-1	-100	330	100		
BC807-25-AU	Single	PNP	-50	-45	-500	-0.7	-500	-50	160	400	-1	-100	330	100		
BC807-40-AU	Single	PNP	-50	-45	-500	-0.7	-500	-50	250	600	-1	-100	330	100		
BC857A-AU	Single	PNP	-50	-45	-100	-0.3	-10	-0.5	125	250	-5	-2	330	-		
BC857B-AU	Single	PNP	-50	-45	-100	-0.3	-10	-0.5	220	475	-5	-2	330	-		
BC857C-AU	Single	PNP	-50	-45	-100	-0.3	-10	-0.5	420	800	-5	-2	330	-		
MMBT3906-AU	Single	PNP	-40	-40	-200	-0.4	-50	-5	100	300	-1	-10	225	250		
BC858A-AU	Single	PNP	-30	-30	-100	-0.3	-10	-0.5	125	250	-5	-2	330	-		
BC858B-AU	Single	PNP	-30	-30	-100	-0.3	-10	-0.5	220	475	-5	-2	330	-		
BC859B-AU	Single	PNP	-30	-30	-100	-0.3	-10	-0.5	220	475	-5	-2	330	-		
BC858C-AU	Single	PNP	-30	-30	-100	-0.3	-10	-0.5	420	800	-5	-2	330	-		
BC859C-AU	Single	PNP	-30	-30	-100	-0.3	-10	-0.5	420	800	-5	-2	330	-		
BC817DPN-AU	Comple.	NPN	50	45	500	0.7	500	50	100	600	1	100	330	100		SOT-23 6L
		PNP	-50	-45	-500	-0.7	-500	-50	100	600	-1	-100	330	100		
IMZ1AS-AU	Comple.	NPN	50	60	150	0.4	50	5	120	560	6	1	300	-		
		PNP	-50	-60	-150	-0.5	-50	-5	120	560	-6	-1	300	-		

Low VCE(sat) Transistors

Part Number	Config.	Type	V _{CBO}	V _{CEO}	I _C	V _{CE(sat)}			h _{FE}				P _{TOT}	f _T	Package
			Max.	Max.	Max.	Max.	I _C	I _B	Min.	Max.	V _{CE}	I _C	Max.	Min.	
			V	V	mA	V	I _C (mA)	I _B (mA)			(V)	(mA)	mW	MHz	
PBHV8110DW-AU	Single	NPN	120	100	1000	0.45	1000	100	100	300	5	500	2600	100	SOT-223
BCP56-16-AU	Single	NPN	120	100	1000	0.5	1000	100	100	250	2	150	2600	100	
BCP53-16-AU	Single	PNP	-120	-100	-1000	-0.6	-1000	-100	100	250	-2	-150	2600	100	
PBHV9110DW-AU	Single	PNP	-120	-100	-1000	-0.6	-1000	-100	100	300	-5	-500	2600	100	SOT-23
PBHV8110DA-AU	Single	NPN	120	100	1000	0.45	1000	100	100	300	5	500	1250	100	
PBHV9110DA-AU	Single	PNP	-120	-100	-1000	-0.6	-1000	-100	100	300	-5	-500	1250	100	SOT-89
PBHV8110DH-AU	Single	NPN	120	100	1000	0.45	1000	100	100	300	5	500	1400	100	
BCX56-16-AU	Single	NPN	120	100	1000	0.5	1000	100	100	250	2	150	1400	100	
BCX53-16-AU	Single	PNP	-120	-100	-1000	-0.6	-1000	-100	100	250	-2	-150	1400	100	SOT-89
PBHV9110DH-AU	Single	PNP	-120	-100	-1000	-0.6	-1000	-100	100	300	-5	-500	1400	100	

AC-DC Switching Controller

Resonant Flyback Controller

Part Number	Description	Topology	Package	Comment
DRFLYBACK-A	High and Low side are almost always ZVS	Flyback	TSSOP-18	High Density and Output Power <150W AC to DC Adaptor/Charger
	Operation mode	Protection Mode		Temperature range
	CRM/DCM	OVP, OCP, SCP		°C -40 to 125

Active Bridge Controller

Part Number	Description	Topology	Package	Comment
CMDRBR	Self-Powered controller for MOSFET	Bridge	SOT-26-1	AC to DC SMPS/Adaptor/Charger
	Operation current	No load consumption		Temperature range
	µA	mW		°C
	20	<20		-40 to 125°

Automatic × Capacitor Discharge IC

Part Number	Description	Package	Comment
CMD02XIU	Prevents current through × capacitor discharge resistors when AC voltage is connected	SOD-123	AC to DC power supply, Meet safety ICE 60065/60950/62368
	Break down voltage	Power consumption	
	KV	mW	
	1	5.8	
			Temperature range °C -55 to 150

ZVS-Like PFC Controller

Part Number	Description	Package	Comment
CM6500UNXIS*	EPA/90+ , Design for High Efficient Power Supply at both Full Load and Light Load	14-Pin SOP	Dynamic Soft PFC to ease the stress over the entire external power device is reduced and EMI noisereduced
	Maximun Vcc	Maximun Start-Up current	
	V	µA	
	21	75	
			Temperature range °C -40 to 125

*Under Development

Secondary Side LLC Resonant Controller with Synchronous Rectifier Control

Part Number	Description	Package	Comment
CU6901VACIS*	operate at both SRC and LLC region with synchronous rectification to achieve high efficiency. Itsunique features: FM+2PWMING+kick modes.	16-Pin SOP	Power System can be either Voltage source or Current source Titanium+, EuP lot6, Server Grade, PC, TV, LED, AC Adapter
	Maximun Vcc	Maximun Start-Up current	
	V	µA	
	18	80	
			Temperature range °C -40 to 125

*Under Development

Battery Management IC

Battery Gas Gauge

Part Number	Cell Chemistry	Number of Series Cells	Interface or I/F	Battery Capacity Min.	
				mAh	
PJ67250QW	Li-Ion, Li-Polymer	2-5 Cells	SMBus	100	
	Battery Capacity Max.	Implementation	Indication	Package	
	mAh				
	65000	Pack	LED	QFN4x4-32	
	Operating Temperature Range	Features			
	°C				
-40 to 85	Cell Balancing, TURBO Mode 3.0, Integrated Protector, SHA-1/SHA-256, ECC Authentication				

DC-DC Switching Regulator

Boost Regulator

Part Number	V _{IN}		V _{OUT}		I _{OUT}	I _Q	Control Mode	Frequency	N MOS RDS(on)	P MOS RDS(on)	Duty Cycle	Synchronous Rectification	Package
	Min.	Max.	Min.	Max.	Max.	Typ.		Typ.	Typ.				
	V	V	V	V	A	uA		KHz	mΩ	mΩ			
PJ30072S6	0.75	5.0	1.8	5.5	0.75	12	-	1000	250	350	-	Yes	SOT23-6

Buck-Boost Regulator

Part Number	V _{IN}		V _{OUT}		I _{OUT}	I _Q	Interface	Frequency	Buck MOS RDS(on)	Boost MOS RDS(on)	Duty Cycle	Synchronous Rectification	Package
	Min.	Max.	Min.	Max.	Max.	Typ.		Typ.	Typ.				
	V	V	V	V	A	uA		KHz	mΩ	mΩ			
PJ32247B*	3.7	36	1	22	6	350	I2C	420	18	13	-	-	VQFN3x5-20
PJ32248*	3.7	36	2.5	29	6	350	I2C	420	18	12	-	-	

*Under Development

Low Noise LDO

Part Number	V _{IN}		V _{OUT}		I _{OUT}	Regulated Output Voltage	V _{OUT} Tolerance	PSRR @ 1kHz	I _Q	V _{DROP}	Off Discharge	Package
	Min.	Max.	Min.	Max.	Max.							
	V	V	V	V	A	V	%	Typ.	Typ.	Typ.		
PJ20030A-08S5	1.6	5.5	0.8	0.8	0.3	Fixed, 0.8	±1	75	25	170	Yes	SOT23-5
PJ20030A-18S5	1.6	5.5	1.8	1.8	0.3	Fixed, 1.8	±1	75	25	170	Yes	
PJ20030A-28S5	1.6	5.5	2.8	2.8	0.3	Fixed, 2.8	±1	75	25	170	Yes	
PJ20030A-33S5	1.6	5.5	3.3	3.3	0.3	Fixed, 3.3	±1	75	25	170	Yes	
PJ20030A-08QZ1	1.6	5.5	0.8	0.8	0.3	Fixed, 0.8	±1	75	25	170	Yes	
PJ20030A-18QZ1	1.6	5.5	1.8	1.8	0.3	Fixed, 1.8	±1	75	25	170	Yes	
PJ20030A-28QZ1	1.6	5.5	2.8	2.8	0.3	Fixed, 2.8	±1	75	25	170	Yes	
PJ20030A-33QZ1	1.6	5.5	3.3	3.3	0.3	Fixed, 3.3	±1	75	25	170	Yes	
PJ20030A-08QZ	1.6	5.5	0.8	0.8	0.3	Fixed, 0.8	±1	75	25	170	Yes	DFN0.8x0.8-4
PJ20030A-18QZ	1.6	5.5	1.8	1.8	0.3	Fixed, 1.8	±1	75	25	170	Yes	
PJ20030A-28QZ	1.6	5.5	2.8	2.8	0.3	Fixed, 2.8	±1	75	25	170	Yes	
PJ20030A-33QZ	1.6	5.5	3.3	3.3	0.3	Fixed, 3.3	±1	75	25	170	Yes	
PJ20030A-08QW	1.6	5.5	0.8	0.8	0.3	Fixed, 0.8	±1	75	25	170	Yes	
PJ20030A-18QW	1.6	5.5	1.8	1.8	0.3	Fixed, 1.8	±1	75	25	170	Yes	
PJ20030A-28QW	1.6	5.5	2.8	2.8	0.3	Fixed, 2.8	±1	75	25	170	Yes	
PJ20030A-33QW	1.6	5.5	3.3	3.3	0.3	Fixed, 3.3	±1	75	25	170	Yes	
PJ20030B-08S5	1.6	5.5	0.8	0.8	0.3	Fixed, 0.8	±1	75	25	170	No	SOT23-5
PJ20030B-18S5	1.6	5.5	1.8	1.8	0.3	Fixed, 1.8	±1	75	25	170	No	
PJ20030B-28S5	1.6	5.5	2.8	2.8	0.3	Fixed, 2.8	±1	75	25	170	No	
PJ20030B-33S5	1.6	5.5	3.3	3.3	0.3	Fixed, 3.3	±1	75	25	170	No	
PJ20030B-08QZ1	1.6	5.5	0.8	0.8	0.3	Fixed, 0.8	±1	75	25	170	No	
PJ20030B-18QZ1	1.6	5.5	1.8	1.8	0.3	Fixed, 1.8	±1	75	25	170	No	
PJ20030B-28QZ1	1.6	5.5	2.8	2.8	0.3	Fixed, 2.8	±1	75	25	170	No	
PJ20030B-33QZ1	1.6	5.5	3.3	3.3	0.3	Fixed, 3.3	±1	75	25	170	No	
PJ20030B-08QZ	1.6	5.5	0.8	0.8	0.3	Fixed, 0.8	±1	75	25	170	No	DFN0.8x0.8-4
PJ20030B-18QZ	1.6	5.5	1.8	1.8	0.3	Fixed, 1.8	±1	75	25	170	No	
PJ20030B-28QZ	1.6	5.5	2.8	2.8	0.3	Fixed, 2.8	±1	75	25	170	No	
PJ20030B-33QZ	1.6	5.5	3.3	3.3	0.3	Fixed, 3.3	±1	75	25	170	No	
PJ20030B-08QW	1.6	5.5	0.8	0.8	0.3	Fixed, 0.8	±1	75	25	170	No	
PJ20030B-18QW	1.6	5.5	1.8	1.8	0.3	Fixed, 1.8	±1	75	25	170	No	
PJ20030B-28QW	1.6	5.5	2.8	2.8	0.3	Fixed, 2.8	±1	75	25	170	No	
PJ20030B-33QW	1.6	5.5	3.3	3.3	0.3	Fixed, 3.3	±1	75	25	170	No	
PJ20050AQW*	1.7	6	0.55	5.5	0.5	Adjustable	±1	64	27	150	Yes	DFN1.2x1.2-6
PJ20050AQZ*	1.7	6	0.55	5.5	0.5	Adjustable	±1	64	27	150	Yes	
PJ20050BQW*	1.7	6	0.55	5.5	0.5	Adjustable	±1	64	27	150	No	
PJ20050BQZ*	1.7	6	0.55	5.5	0.5	Adjustable	±1	64	27	150	No	

*Under Development

Low Iq LDO

Part Number	V _{IN}		V _{OUT}		I _{OUT}	Regulated Output Voltage	V _{OUT} Tolerance	PSRR @ 1kHz	I _Q	V _{DROP}	Off Discharge	Package
	Min.	Max.	Min.	Max.	Max.							
	V	V	V	V	A	V	%	Typ.	Typ.	Typ.		
PJ20705A-12S5*	1.8	5.5	1.2	1.2	0.15	Fixed, 1.2	±1	63	0.5	170	Yes	SOT23-5
PJ20705A-15S5*	1.8	5.5	1.5	1.5	0.15	Fixed, 1.5	±1	63	0.5	170	Yes	
PJ20705A-30S5*	1.8	5.5	3.0	3.0	0.15	Fixed, 3.0	±1	63	0.5	170	Yes	
PJ20705A-33S5*	1.8	5.5	3.3	3.3	0.15	Fixed, 3.3	±1	63	0.5	170	Yes	
PJ20705A-12QZ1*	1.8	5.5	1.2	1.2	0.15	Fixed, 1.2	±1	63	0.5	170	Yes	
PJ20705A-15QZ1*	1.8	5.5	1.5	1.5	0.15	Fixed, 1.5	±1	63	0.5	170	Yes	
PJ20705A-30QZ1*	1.8	5.5	3.0	3.0	0.15	Fixed, 3.0	±1	63	0.5	170	Yes	
PJ20705A-33QZ1*	1.8	5.5	3.3	3.3	0.15	Fixed, 3.3	±1	63	0.5	170	Yes	
PJ20705B-12S5*	1.8	5.5	1.2	1.2	0.15	Fixed, 1.2	±1	63	0.5	170	No	SOT23-5
PJ20705B-15S5*	1.8	5.5	1.5	1.5	0.15	Fixed, 1.5	±1	63	0.5	170	No	
PJ20705B-30S5*	1.8	5.5	3.0	3.0	0.15	Fixed, 3.0	±1	63	0.5	170	No	
PJ20705B-33S5*	1.8	5.5	3.3	3.3	0.15	Fixed, 3.3	±1	63	0.5	170	No	
PJ20705B-12QZ1*	1.8	5.5	1.2	1.2	0.15	Fixed, 1.2	±1	63	0.5	170	No	
PJ20705B-15QZ1*	1.8	5.5	1.5	1.5	0.15	Fixed, 1.5	±1	63	0.5	170	No	
PJ20705B-30QZ1*	1.8	5.5	3.0	3.0	0.15	Fixed, 3.0	±1	63	0.5	170	No	
PJ20705B-33QZ1*	1.8	5.5	3.3	3.3	0.15	Fixed, 3.3	±1	63	0.5	170	No	

*Under Development

Power Switches

Load Switches

Part Number	No. of Outputs	V_{IN}		RDS(on)	I_Q	Current Limit	Enable	Operating Temperature	Package
		Min.	Max.	Typ.	Typ.	Typ.		Range	
		V	V	m Ω	μ A	A		$^{\circ}$ C	
PJ52916AQW	1	0.6	5.5	13	28	6	Logic High	-40 to 125	DFN2x2-8
PJ52916BQW	1	0.6	5.5	13	28	6	Logic Low	-40 to 125	
PJ52926QW*	2	0.8	5.5	20	40	6	Logic High	-40 to 125	DFN3x2-14

*Under Development

Amplifier

Comparators

Part Number	No. of Channels	V_{IN}		V_{IO}	I_{IO}	I_{CC}	$I_{IB} (\pm)$	A_{VD}	Response Time	Operating Temperature Range	Package
		Min.	Max.	Max.	Max.	Typ.	Max.	Typ.			
		V	V	mV	nA	uA	nA	V/mV	μ s	$^{\circ}$ C	
PJ76393	2	2	32	5	50	800	250	200	1.3	-40 to 85	SOP-8P
PJ76339	4	2	32	5	50	800	250	200	1.3	-40 to 85	SOP-14P
PJ76339	4	2	32	5	50	800	250	200	1.3	-40 to 85	TSSOP-14P

*Under Development

Operational Amplifier

Part Number	No. of Channels	V_{IN}		V_{IO}	I_{IO}	I_{CC}	$I_{IB} (\pm)$	CMRR	A_{VD}	Operating Temperature Range	Package
		Min.	Max.	Max.	Max.	Typ.	Max.	Typ.	Typ.		
		V	V	mV	nA	uA	nA	dB	V/mV	$^{\circ}$ C	
PJ76324	4	3	32	7	50	1100	250	80	100	-40 to 85	SOP-14P
PJ76324	4	3	32	7	50	1100	250	80	100	-40 to 85	TSSOP-14P
PJ76358	2	3	36	7	50	700	250	80	100	-40 to 85	SOP-8P
PJ76007*	1	3	18	0.15	3.8	-	4	123	500	-40 to 85	

*Under Development

Current Sense Amplifier

Part Number	Interface	V_{CM}		V_{VS}		$V_{OS} (\pm)$	I_{IB}	CMRR	Gain Error	Gain Error Drift (\pm)	Package
		Min.	Max.	Min.	Max.	Max.	Typ.	Typ.	Max.	Max.	
		V	V	V	V	uV	uA	dB	%	ppm/ $^{\circ}$ C	
PJ75233QW*	I2C, SMBus	0	36	2.7	5.5	10	8	140	0.1	50	DFN3x3-10
PJ75233M*	I2C, SMBus	0	36	2.7	5.5	10	8	140	0.1	50	MSOP-10P

*Under Development

Sensors

Temperature Sensors

Part Number	V _{CC}	V _{CC}	I _{AOC}	T _{LAC} (Full Temp.)	T _{RAC} (Full Temp.)	Interface	Resolution	Operating Temperature	Package
	Min.	Max.	Typ.	Max.	Max.		Max.	Range	
	V	V	uA	°C	°C		bits	°C	
PJ85718M	1.75	5.5	45	+1.8/-1.8	+2/-2	SMBus, 2-wire, I2C	11	-40 to 125	MSOP-8P
PJ85718AM	1.75	5.5	45	+1.8/-1.8	+2/-2	SMBus, 2-wire, I2C	11	-40 to 125	
PJ85718BM	1.75	5.5	45	+1.8/-1.8	+2/-2	SMBus, 2-wire, I2C	11	-40 to 125	
PJ85718CM	1.75	5.5	45	+1.8/-1.8	+2/-2	SMBus, 2-wire, I2C	11	-40 to 125	
PJ85718DM	1.75	5.5	45	+1.8/-1.8	+2/-2	SMBus, 2-wire, I2C	11	-40 to 125	
PJ85718EM	1.75	5.5	45	+1.8/-1.8	+2/-2	SMBus, 2-wire, I2C	11	-40 to 125	
PJ85718FM	1.75	5.5	45	+1.8/-1.8	+2/-2	SMBus, 2-wire, I2C	11	-40 to 125	
PJ85718GM	1.75	5.5	45	+1.8/-1.8	+2/-2	SMBus, 2-wire, I2C	11	-40 to 125	
PJ85753AS5*	1.40	5.5	3	+2.0/-2.0	-	SMBus, I2C	12	-40 to 125	SOT23-5
PJ85753JS5*	1.40	5.5	3	+2.0/-2.0	-	SMBus, I2C	12	-40 to 125	SOP-8P
PJ85775P*	1.75	5.5	3	+1.5/-1.5	-	SMBus, 2-wire, I2C	12	-40 to 125	MSOP-8P
PJ86775M*	1.75	5.5	3	+1.5/-1.5	-	SMBus, 2-wire, I2C	12	-40 to 125	

*Under Development

Small Signal MOSFET

Part Number	Ch.	Config.	V _{DS}	V _{GS}	I _D	ESD	R _{DS(on)} Max. (mΩ)						C _{iss} Typ.	V _{GS(th)} Max.	Q _g Typ. (nC)		Package	
			V	±V	A		10V	4.5V	2.5V	1.8V	1.5V	1.2V	pF	V	10V	4.5V		
PJQ1906	N	Single	30	10	0.3	Y	-	1200	1600	2000	3000	4000	45	1	0.9	-	DFN1006-3L	
PJQ1908	N	Single	50	20	0.5	Y	1450	1950	4000	6000	-	-	36	1	-	0.95		
PJQ1938	N	Single	50	20	0.6	Y	1450	1950	4000	6000	-	-	32	1.5	1.7	-		
PJQ1938L	N	Single	60	20	0.24	Y	4200	5000	7000	-	-	-	15	1.5	-	0.7		
PJQ1912	N	Single	60	20	0.41	Y	3000	4000	-	-	-	-	20	2.5	1.5	-		
PJQ1901	P	Single	-20	10	-0.75	Y	-	1200	1500	2200	3600	6000	38	-1	-	1.4		
PJV138L	N	Single	60	20	0.13	Y	4200	5000	7000	-	-	-	15	1.5	-	0.7	SOT-723	
PJX8828	N/N	Dual	30	10	0.3	Y	-	1200	1600	2000	3000	4000	45	1	0.9	-	SOT-563	
PJX138K	N/N	Dual	50	20	0.35	Y	1600	2500	4500	-	-	-	25	1.5	-	0.63		
PJX8838	N/N	Dual	50	20	0.36	Y	1450	1950	4000	6000	-	-	36	1	-	0.95		
PJX138L	N/N	Dual	60	20	0.16	Y	4200	5000	7000	-	-	-	15	1.5	-	0.7		
PJX8872B	N/N	Dual	60	30	0.2	-	3000	4000	-	-	-	-	34	2.5	-	0.82		
PJX8807	P/P	Dual	-20	10	-0.5	Y	-	1200	1500	2200	3600	6000	38	-1	-	1.4		
PJX8839	P/P	Dual	-60	20	-0.2	-	4000	6000	-	-	-	-	51	-2.5	-	1.1		
PJX8601	N	Comple.	20	10	0.5	Y	-	400	650	800	1200	3000	38	0.9	-	1.4		
	P		-20	10	-0.5	Y	-	1200	1500	2200	3600	6000	67	-1	-	1.4		
PJX8603	N	Comple.	50	20	0.36	Y	1500	2500	-	-	-	-	36	1	-	0.95		
	P		-60	20	-0.2	Y	6000	7000	-	-	-	-	51	-2.5	-	1.1		
PJE8428	N	Single	30	10	0.3	Y	-	1200	1600	2000	3000	4000	45	1	0.9	-		SOT-523
PJE138K	N	Single	50	20	0.35	Y	1600	2500	4500	-	-	-	25	1.5	-	0.63		
PJE8438	N	Single	50	20	0.36	Y	1450	1950	4000	6000	-	-	36	1	-	0.95		
PJE138L	N	Single	60	20	0.16	Y	4200	5000	7000	-	-	-	15	1.5	-	0.7		
2N7002KTB	N	Single	60	20	0.1	Y	3000	4000	-	-	-	-	35	2.5	-	0.8		
PJE8472B	N	Single	60	30	0.2	-	3000	4000	-	-	-	-	34	2.5	-	0.82		
PJE8407	P	Single	-20	10	-0.5	Y	-	1200	1500	2200	3600	6000	38	-1	-	1.4		
PJE8439	P	Single	-60	20	-0.2	-	4000	6000	-	-	-	-	51	-2.5	-	1.1		
PJT7828	N/N	Dual	30	10	0.3	Y	-	1200	1600	2000	3000	4000	45	1	0.9	-	SOT-363	
PJT7838	N/N	Dual	50	20	0.4	Y	1450	1950	4000	6000	-	-	36	1	-	0.95		
PJT138K	N/N	Dual	50	20	0.36	Y	1600	2500	4500	-	-	-	25	1.5	-	0.63		
PJT7002H	N/N	Dual	60	20	0.25	Y	5000	-	-	-	-	-	22	3	1.3	-		
PJT138L	N/N	Dual	60	20	0.2	Y	4200	5000	7000	-	-	-	15	1.5	-	0.7		
PJT7872B	N/N	Dual	60	30	0.25	-	3000	4000	-	-	-	-	34	2.5	-	0.82		
2N7002KDW	N/N	Dual	60	20	0.1	Y	3000	4000	-	-	-	-	35	2.5	-	0.8		
PJT7807	P/P	Dual	-20	10	-0.5	Y	-	1200	1500	2200	3600	6000	38	-1	-	1.4		
PJT7839	P/P	Dual	-60	20	-0.25	-	4000	6000	-	-	-	-	51	-2.5	-	1.1		
PJT7601	N	Comple.	20	10	0.5	Y	-	400	650	800	1200	3000	38	0.9	-	1.4		
	P		-20	10	-0.5	Y	-	1200	1500	2200	3600	6000	67	-1	-	1.4		
PJT7603	N	Comple.	50	20	0.4	Y	1500	2500	-	-	-	-	36	1	-	0.95		
	P		-60	20	-0.25	Y	4000	6000	-	-	-	-	51	-2.5	-	1.1		
PJC7428	N	Single	30	10	0.3	Y	-	1200	1600	2000	3000	4000	45	1	0.9	-	SOT-323	
PJC138K	N	Single	50	20	0.36	Y	1600	2500	4500	-	-	-	25	1.5	-	0.63		
PJC7438	N	Single	50	20	0.4	Y	1450	1950	4000	6000	-	-	36	1	-	0.95		
PJC7002H	N	Single	60	20	0.25	Y	5000	-	-	-	-	-	22	3	1.3	-		
PJC138L	N	Single	60	20	0.2	Y	4200	5000	7000	-	-	-	15	1.5	-	0.7		
PJC7472B	N	Single	60	30	0.25	-	3000	4000	-	-	-	-	34	2.5	-	0.82		
2N7002KW	N	Single	60	20	0.1	Y	3000	4000	-	-	-	-	35	2.5	-	0.8		
PJC7476	N	Single	100	20	0.3	Y	6000	9000	-	-	-	-	45	2.5	1.8	-		
PJC7409	P	Single	-20	10	-0.5	Y	-	1200	1500	2200	3600	6000	38	-1	-	1.4		
PJC7439	P	Single	-60	20	-0.25	-	4000	6000	-	-	-	-	51	-2.5	-	1.1		
PJA3428	N	Single	30	10	0.3	Y	-	1200	1600	2000	3000	4000	45	1	0.9	-		SOT-23
PJA138K	N	Single	50	20	0.5	Y	1600	2500	4500	-	-	-	25	1.5	-	0.63		
PJA3438	N	Single	50	20	0.5	Y	1450	1950	4000	6000	-	-	36	1	-	0.95		
PJA7002H	N	Single	60	20	0.3	Y	5000	-	-	-	-	-	22	3	1.3	-		
PJA138L	N	Single	60	20	0.25	Y	4200	5000	7000	-	-	-	15	1.5	-	0.7		
2N7002K	N	Single	60	20	0.3	Y	3000	4000	-	-	-	-	35	2.5	-	0.8		
PJA3472B	N	Single	60	30	0.3	-	3000	4000	-	-	-	-	34	2.5	-	0.82		
PJA3476	N	Single	100	20	0.3	Y	6000	9000	-	-	-	-	45	2.5	1.8	-		
BSS123	N	Single	100	20	0.17	Y	6000	10000	-	-	-	-	45	2.5	1.8	-		
PJA3435	P	Single	-20	10	-0.5	Y	-	1200	1500	2200	3600	6000	38	-1	-	1.4		
PJA3439	P	Single	-60	20	-0.3	-	4000	6000	-	-	-	-	51	-2.5	-	1.1		
PJS6839	P/P	Dual	-60	20	-0.3	-	4000	6000	13000	-	-	-	51	-2.5	-	1.1	SOT-23 6L	

Low Voltage MOSFET

Part Number	Ch.	Config.	V _{DS}	V _{GS}	I _D	ESD	R _{DS(on)} Max. (mΩ)						Ciss Typ.	V _{GS(th)} Max.	Q _g Typ. (nC)		Package	
			V	±V	A		10V	4.5V	2.5V	1.8V	1.5V	1.2V	pF	V	10V	4.5V		
			PJQ1916	N	Single		20	8	0.95	Y	-	300	400	550	800	1500		46
PJQ1917	P	Single	-20	8	-0.7	Y	-	600	850	1200	1600	3000	51	-1	1.1	-		
PJQ1820U-20V	N/N	Dual	20	8	1	Y	-	300	400	550	800	1500	46	0.8	-	1.1	DFN1010B-6L	
PJQ2800	N/N	Dual	20	8	5.2	Y	-	32	45	65	-	-	515	0.9	-	6.3		
PJQ2815	P/P	Dual	-20	8	-4.2	Y	-	52	62	73	-	-	907	-0.9	-	24	DFN2020-6L	
PJQ2405	P	Single	-20	8	-7.2	-	-	32	39	48	-	-	1785	-0.9	-	18.9		
PJQ2407	P	Single	-30	20	-8.4	-	20	32	-	-	-	-	1169	-2.5	-	11	DFN2020B-6L	
PJQ2408	N	Single	30	20	10	-	11.5	15	-	-	-	-	781	2.5	-	6.9		
PJQ2409	P	Single	-30	20	-6.5	-	32	45	-	-	-	-	870	-2.5	-	7.8		
PJQ2410	N	Single	30	20	10	-	12	18	-	-	-	-	660	2.5	-	7.1		
PJQ2414	N	Single	20	8	8.6	Y	-	17	21	34	-	-	633	1	-	7.6		
PJQ2416	N	Single	20	10	11	Y	-	11	13	17	-	-	1177	1	-	16		
PJQ2422	N	Single	30	20	8	-	18	28	-	-	-	-	392	2.5	-	4.3		
PJQ2888	P	Asym.	-20	8	-1.5	Y	-	325	420	600	-	-	150	-1	-	2.2		DFN2020-8L
PJQ4410P	N	Single	30	20	35	-	12	18	-	-	-	-	660	2.5	-	7.1	DFN3333-8L	
PJQ4414P	N	Single	30	20	25	-	18	28	-	-	-	-	392	2.5	-	4.3		
PJQ4524P	N	Single	30	20	75	-	4.2	7	-	-	-	-	1260	2.5	21	-		
PJQ4526P	N	Single	30	20	62	Y	5.5	8.3	-	-	-	-	923	2.5	15	-		
PJQ4528P	N	Single	30	20	51	Y	6.5	10.5	-	-	-	-	785	2.5	10.7	-		
PJQ4530P	N	Single	30	20	45	-	7.8	13	-	-	-	-	600	2.5	12.4	-		
PJQ4534P	N	Single	30	20	36	Y	8.9	14.7	-	-	-	-	490	2.5	9.5	-		
PJQ4442P	N	Single	40	20	50	-	7.5	10.5	-	-	-	-	1759	2.5	-	17		
PJQ4446P	N	Single	40	20	48	-	9	13	-	-	-	-	1258	2.5	22	-		
PJQ4448P	N	Single	40	20	42	-	11	15	-	-	-	-	1040	2.5	-	10		
PJQ4411P	P	Single	-20	12	-60	-	-	8	11	16	-	-	4569	-1	-	46.8		
PJQ4423DP	P	Single	-20	12	-40	-	-	12.5	17.5	26	-	-	2115	-0.9	22	-		
PJQ4425DP	P	Single	-20	12	-45	-	-	10	14	23	-	-	2736	-0.9	29	-		
PJQ4427DP	P	Single	-20	12	-53	-	-	7	9	13.5	-	-	4389	-0.9	45	-		
PJQ4433EP	P	Single	-30	25	-62	Y	8.8	14	-	-	-	-	2310	-2.5	54	-		
PJQ4435EP	P	Single	-30	25	-41	Y	12.5	20.3	-	-	-	-	1610	-2.5	34	-		
PJQ4437EP	P	Single	-30	25	-38	Y	15.4	27	-	-	-	-	1270	-2.5	32	-		
PJQ4439EP	P	Single	-30	25	-30	Y	19.1	31.2	-	-	-	-	1012	-2.5	22	-		
PJQ4441P	P	Single	-40	20	-44	-	17	25	-	-	-	-	2030	-2.5	-	19		
PJQ4443P	P	Single	-40	20	-46	-	12	17.5	-	-	-	-	2767	-2.5	-	23		
PJQ4848P	N/N	Dual	40	20	37	-	15	20	-	-	-	-	1040	2.5	-	10		DFN3333B-8L
PJQ5412	N	Single	30	20	45	-	12	18	-	-	-	-	660	2.5	-	7.1		DFN5060-8L
PJQ5442	N	Single	40	20	90	-	5.5	7.5	-	-	-	-	1258	2.5	-	25		
PJQ5444	N	Single	40	20	70	-	6.5	9	-	-	-	-	1759	2.5	-	17		
PJQ5446	N	Single	40	20	70	-	9.5	14	-	-	-	-	1258	2.5	22	-		
PJQ5448	N	Single	40	20	50	-	11	15	-	-	-	-	1040	2.5	-	10		
PJQ5441	P	Single	-40	20	-80	-	6.5	9	-	-	-	-	6324	-2.5	128	-		
PJQ5443	P	Single	-40	20	-50	-	12	17.5	-	-	-	-	2767	-2.5	-	23		
PJQ5844	N/N	Dual	40	20	45	-	8	10.5	-	-	-	-	1759	2.5	-	17		
PJQ5846	N/N	Dual	40	20	40	-	10.5	15	-	-	-	-	1258	2.5	22	-	DFN5060B-8L	
PJQ5848	N/N	Dual	40	20	30	-	12	16	-	-	-	-	1040	2.5	-	10		
PJQ5850	N/N	Dual	40	20	14	-	33	42	-	-	-	-	425	2.5	-	4.4		
PJQ5606	N/P	Comple.	30	20	25	-	19	28	-	-	-	-	429	2.5	-	4.8		
			-30	20	-22	-	30	45	-	-	-	-	846	-2.5	-	7.8		

Low Voltage MOSFET

Part Number	Ch.	Config.	V _{DS}	V _{GS}	I _D	ESD	R _{DS(on)} Max. (mΩ)						Ciss Typ.	V _{GS(th)} Max.	Q _g Typ. (nC)		Package
			V	±V	A		10V	4.5V	2.5V	1.8V	1.5V	1.2V	pF	V	10V	4.5V	
			PJQ5524	N	Single		30	20	85	-	3.6	6.1	-	-	-	-	
PJQ5526	N	Single	30	20	68	Y	4.9	7.8	-	-	-	-	923	2.5	15	-	
PJQ5528	N	Single	30	20	58	Y	6	9.8	-	-	-	-	710	2.5	11	-	
PJQ5530	N	Single	30	20	49	Y	7.3	12.7	-	-	-	-	600	2.5	12.4	-	
PJQ5534	N	Single	30	20	37	Y	8.9	14.7	-	-	-	-	490	2.5	9.5	-	
PJQ5433E	P	Single	-30	25	-68	Y	8.4	13.5	-	-	-	-	2310	-2.5	54	-	
PJQ5435E	P	Single	-30	25	-45	Y	12.1	20	-	-	-	-	1610	-2.5	34	-	
PJQ5437E	P	Single	-30	25	-38	Y	15	26	-	-	-	-	1270	-2.5	32	-	
PJQ5439E	P	Single	-30	25	-30	Y	18.8	30.7	-	-	-	-	1009	-2.5	22	-	
PJV1716	N	Single	20	8	0.57	Y	-	300	400	550	800	1500	50	1	-	1.1	SOT-723
PJV1717	P	Single	-20	8	0.42	Y	-	600	850	1200	1600	3000	57.5	-1	-	1.2	
PJE8400	N	Single	20	12	1.1	-	-	88	100	130	-	-	350	1.2	-	4.6	
PJE8402	N	Single	20	8	0.7	Y	-	150	220	400	-	-	92	1	-	1.6	SOT-523
PJE8404	N	Single	30	8	0.6	Y	-	220	290	600	-	-	93	1.3	-	1.5	
PJE8406	N	Single	20	12	0.8	Y	-	400	700	1200	-	-	50	1	-	0.92	
PJE8408	N	Single	20	10	0.5	Y	-	400	650	800	1200	3000	67	0.9	-	1.4	
PJE8401	P	Single	-20	12	-0.9	-	-	130	160	210	-	-	416	-1.2	-	5.4	
PJE8403	P	Single	-20	8	-0.6	Y	-	340	420	600	-	-	151	-1	-	2.2	
PJE8405	P	Single	-30	8	-0.5	Y	-	390	560	990	-	-	137	-1.3	-	1.6	
PJX8802	N/N	Dual	20	8	0.7	Y	-	150	220	400	-	-	92	1	-	1.6	SOT-563
PJX8804	N/N	Dual	30	8	0.6	Y	-	220	290	600	-	-	93	1.3	-	1.5	
PJX8808	N/N	Dual	20	10	0.5	Y	-	400	650	800	1200	3000	67	0.9	-	1.4	
PJX8803	P/P	Dual	-20	8	-0.6	Y	-	340	420	600	-	-	151	-1	-	2.2	SOT-563
PJX8805	P/P	Dual	-30	8	-0.5	Y	-	390	560	990	-	-	137	-1.3	-	1.6	
PJC7404	N	Single	20	8	1	Y	-	150	215	400	-	-	92	1	-	1.6	
PJC7406	N	Single	20	12	1.3	-	-	77	90	120	-	-	350	1.2	-	4.6	SOT-323
PJC7400	N	Single	30	12	1.9	-	70	75	85	110	-	-	447	1.2	4.8	-	
PJC7410	N	Single	20	10	0.5	Y	-	400	650	800	1200	3000	67	0.9	-	m	
PJC7400B	N	Single	30	8	1	Y	-	200	270	570	-	-	93	1.3	-	1.5	
PJT7800	N/N	Dual	20	8	1	Y	-	150	215	400	-	-	92	1	-	1.6	SOT-363
PJT7808	N/N	Dual	20	10	0.5	Y	-	400	650	800	1200	3000	67	0.9	-	1.4	
PJT7816	N/N	Dual	20	8	0.75	Y	-	400	500	650	1000	2000	50	1	-	1.1	
PJC7401	P	Single	-30	12	-1.5	-	115	130	180	-	-	-	443	-1.3	11	-	
PJC7403	P	Single	-20	8	-0.7	Y	-	325	420	600	-	-	165	-1	-	2.2	
PJC7407	P	Single	-20	12	-1.3	-	-	125	150	200	-	-	416	-1.2	-	5.4	
PJT7413	P	Single	-20	12	-2.5	-	-	85	115	150	250	-	522	-1.2	-	7	
PJT7801	P/P	Dual	-20	8	-0.7	Y	-	325	420	600	-	-	165	-1	-	2.2	
PJT7600	N/P	Comple.	20	8	1	Y	-	150	215	400	-	-	92	1	-	1.6	
PJT7600	N/P	Comple.	-20	8	-0.7	Y	-	325	420	600	-	-	151	-1	-	2.2	
PJW8N03	N	Single	30	20	7.2	-	38	55	-	-	-	-	343	2.1	7.8	-	SOT-223
PJW7N04	N	Single	40	20	6.5	-	42	51	-	-	-	-	410	2.5	-	4.8	
PJW5P03	P	Single	-30	20	-4.6	-	50	80	-	-	-	-	516	-2.5	-	4.8	
PJA3400	N	Single	30	12	4.9	-	38	44	60	-	-	-	490	1.3	5.7	-	SOT-23
PJA3402	N	Single	30	12	4.4	-	48	53	66	92	-	-	447	1.2	11.3	-	
PJA3404	N	Single	30	20	5.6	-	30	45	-	-	-	-	343	2.1	7.8	-	
PJA3404A	N	Single	30	20	5.6	-	23	29	-	-	-	-	602	2.1	12.8	-	
PJA3406	N	Single	30	20	4.4	-	48	70	-	-	-	-	235	2.1	5.8	-	
PJA3412	N	Single	20	12	4.1	-	-	56	68	95	-	-	350	1.2	-	4.6	
PJA3414	N	Single	20	12	5.2	-	-	36	52	92	-	-	396	1.2	-	4.1	
PJA3416	N	Single	20	12	5.8	-	-	27	40	80	-	-	513	1.2	-	6.7	
PJA3416AE	N	Single	20	8	6.5	Y	-	22	26	34	-	-	836	1	-	8.6	
PJA3420E	N	Single	20	8	5.1	Y	-	27	33	46	-	-	515	0.9	-	6.3	
PJA3424E	N	Single	30	12	4.2	Y	42	48	55	-	-	-	430	1.3	-	6	
PJA3430	N	Single	20	8	2	Y	-	150	215	400	-	-	92	1	-	1.8	
PJA3432	N	Single	30	8	1.6	Y	-	200	270	570	-	-	93	1.3	-	1.5	
PJA3434	N	Single	20	10	0.75	Y	-	400	650	800	1200	3000	67	1	-	1.4	
PJA3436	N	Single	20	12	1.2	Y	-	380	680	700	-	-	39	1	-	0.9	
PJA3440	N	Single	40	20	4.3	-	42	51	-	-	-	-	410	2.5	-	4.8	

Low Voltage MOSFET

Part Number	Ch.	Config.	V _{DS}	V _{GS}	I _D	ESD	R _{DS(on)} Max. (mΩ)						Ciss Typ.	V _{GS(th)} Max.	Q _g Typ. (nC)		Package	
			V	±V	A		10V	4.5V	2.5V	1.8V	1.5V	1.2V	pF	V	10V	4.5V		
			PJA3448	N	Single		40	20	3.3	-	71	96	-	-	-	-		241
PJA3401	P	Single	-30	12	-3.6	-	72	82	115	-	-	-	633	-1.3	15	-		
PJA3401A	P	Single	-30	12	-3.6	-	54	63	86	-	-	-	994	-1.3	19	-		
PJA3403	P	Single	-30	12	-3.1	-	98	114	165	-	-	-	443	-1.3	11	-		
PJA3405	P	Single	-30	20	-3.6	-	73	97	-	-	-	-	417	-2.1	10	-		
PJA3407E	P	Single	-30	20	-4	Y	53	80	-	-	-	-	390	-2.3	10.3	-		
PJA3409E	P	Single	-30	20	-3	Y	95	155	-	-	-	-	214	-2.3	6.3	-		
PJA3411	P	Single	-20	12	-3.1	-	-	100	135	190	-	-	416	-1.2	-	5.4		
PJA3413	P	Single	-20	12	-3.4	-	-	82	110	146	-	-	522	-1.2	-	7		
PJA3415	P	Single	-20	12	-4	-	-	57	70	95	-	-	756	-1.2	-	18		
PJA3415AE	P	Single	-20	8	-4.3	Y	-	50	58	73	-	-	907	-1	-	24		
PJA3415A	P	Single	-20	12	-4.5	-	-	46	56	88	-	-	980	-1.3	-	10		
PJA3419E	P	Single	-20	8	-3.7	Y	-	66	90	135	-	-	602	-1.2	-	6.9		
PJA3419AE	P	Single	-20	12	-4	Y	-	50	70	-	-	-	515	-1	7	-		
PJA3431	P	Single	-20	8	-1.5	Y	-	325	420	600	-	-	165	-1	-	1.7		
PJA3433	P	Single	-30	8	-1.1	Y	-	370	540	970	-	-	125	-1.3	-	1.6		
PJA3441	P	Single	-40	20	-3.1	-	88	108	-	-	-	-	505	-2.5	-	6		
PJA3449	P	Single	-40	20	-2.2	-	160	230	-	-	-	-	299	-2.1	7.3	-		
PJS6400	N	Single	30	12	6.4	-	37	43	59	-	-	-	490	1.3	6	-	SOT-23 6L	
PJS6404	N	Single	30	20	6.8	-	32	47	-	-	-	-	343	2.1	7.8	-		
PJS6414	N	Single	20	12	6.6	-	-	36	52	92	-	-	400	1.2	-	4.1		
PJS6416	N	Single	20	12	7.4	-	-	27	41	85	-	-	513	1.2	-	6.8		
PJS6401	P	Single	-30	12	-4.6	-	71	81	110	-	-	-	637	-1.3	15.5	-		
PJS6403	P	Single	-30	20	-6.4	-	37	43	59	-	-	-	870	-2.5	-	7.8		
PJS6405	P	Single	-30	20	-4.6	-	72	96	-	-	-	-	417	-2.1	5.2	-		
PJS6413	P	Single	-20	12	-4.4	-	-	82	110	146	-	-	522	-1.2	7	-		
PJS6415	P	Single	-20	12	-5.2	-	-	56	70	94	-	-	765	-1.2	-	18		
PJS6415A	P	Single	-20	12	-5.2	-	-	46	56	88	-	-	980	-1.3	-	10		
PJS6600	N/P	Comple.	30	8	1.6	Y	-	200	270	570	-	-	93	1.3	-	1.5		
			-30	8	-1.1	Y	-	370	540	970	-	-	125	-1.3	-	1.6		
PJS6602	N/P	Comple.	-20	12	-3.4	-	-	82	110	146	-	-	522	-1.2	-	7		
			20	12	5.2	-	-	36	52	92	-	-	396	1.2	-	4.1		
PJS6604	N/P	Comple.	-30	12	-3.1	-	-	114	165	-	-	-	447	-1.3	5.5	-		
			30	12	4.4	-	-	53	66	-	-	-	443	1.2	5.3	-		
PJS6630	P	Load switching	-20	12	-3.6	Y	53	57	70	-	-	-	-	-	-	-		
PJS6601	N/P	Comple.	-20	12	-3.1	-	-	100	135	190	-	-	416	-1.2	-	5.4		
PJS6601	N/P	Comple.	20	12	4.1	-	-	56	68	95	-	-	350	1.2	-	4.6		
PJS6603	N/P	Comple.	30	20	4.4	-	48	70	-	-	-	-	235	2.1	5.8	-		
			-30	20	-2.9	-	110	150	-	-	-	-	396	-2.1	9.8	-		
PJS6631	P	Load switching	-20	12	-2	Y	100	110	140	-	-	-	-	-	-	-		
PJS6800	N/N	Dual	30	12	3.9	-	48	53	66	-	-	-	490	1.2	11.3	-		
PJS6806	N/N	Dual	30	20	4	-	48	70	-	-	-	-	235	2.1	5.8	-		
PJS6812	N/N	Dual	20	12	3.7	-	-	56	69	98	-	-	350	1.2	-	4.57		
PJS6816	N/N	Dual	20	12	5.2	-	-	29	42	85	-	-	513	1.2	-	7		
PJS6830	N/N	Dual	20	8	2	Y	-	150	215	400	-	-	92	1	1.8	-		
PJS6832	N/N	Dual	30	8	1.6	Y	-	200	270	570	-	-	93	1.3	-	1.5		
PJS6801	P/P	Dual	-30	12	-3.2	-	74	83	115	-	-	-	633	-1.3	15	-		
PJS6809	P/P	Dual	-30	20	-2.6	-	115	150	-	-	-	-	396	-2.1	9.8	-		
PJS6811	P/P	Dual	-20	12	-2.7	-	-	105	135	190	-	-	416	-1.2	-	5.4		
PJS6815	P/P	Dual	-20	12	-3.6	-	-	57	70	95	-	-	756	-1.2	-	18		
PJS6833	P/P	Dual	-30	8	-1.1	Y	-	370	540	970	-	-	125	-1.3	-	1.6		

Low Voltage MOSFET

Part Number	Ch.	Config.	V _{DS}	V _{GS}	I _D	ESD	R _{DS(on)} Max. (mΩ)						C _{iss} Typ.	V _{GS(th)} Max.	Q _g Typ. (nC)		Package
			V	±V	A		10V	4.5V	2.5V	1.8V	1.5V	1.2V	pF	V	10V	4.5V	
PJS6412	N	Single	30	20	8	-	23	32	-	-	-	-	392	2.5	-	4.3	SOT-23 6L-1
PJS6407	P	Single	-30	20	-4.9	-	64	79	-	-	-	-	528	-2.1	14	-	
PJS6417	P	Single	-20	8	-6.5	-	-	35	40	50	-	-	1760	-0.9	-	18.9	
PJS6421	P	Single	-20	10	-7.4	-	-	26	32	40	-	-	1620	-1	-	16.5	
PJD25N03	N	Single	30	20	25	-	25	33	-	-	-	-	392	2.5	-	4.3	
PJD45N03	N	Single	30	20	45	-	12	18	-	-	-	-	660	2.5	-	7.1	TO-252AA
PJD55N03	N	Single	30	20	55	-	9	13	-	-	-	-	763	2.5	-	7.1	
PJD80N03	N	Single	30	20	80	-	6	9	-	-	-	-	1323	2.5	-	12	
PJD85N03	N	Single	30	20	85	-	3.8	5.5	-	-	-	-	2436	2.5	-	23	
PJD25N04	N	Single	40	20	21	-	32	40	-	-	-	-	425	2.5	-	4.4	
PJD40N04	N	Single	40	20	40	-	12	17	-	-	-	-	1040	2.5	-	10	
PJD50N04	N	Single	40	20	50	-	9.5	14	-	-	-	-	1258	2.5	22	-	
PJD60N04	N	Single	40	20	60	-	6.5	9	-	-	-	-	1759	2.5	-	17	
PJD80N04	N	Single	40	20	80	-	5.5	7.5	-	-	-	-	1258	2.5	-	25	
PJD16P04	P	Single	-40	20	-16	-	45	68	-	-	-	-	929	-2.5	-	8.3	
PJD45P04	P	Single	-40	20	-45	-	17	25	-	-	-	-	2030	-2.5	-	19	
PJD50P04	P	Single	-40	20	-50	-	12	17.5	-	-	-	-	2767	-2.5	-	23	

Medium Voltage MOSFET

Part Number	Ch.	Config.	V _{DS}	V _{GS}	I _D	ESD	R _{DS(on)} Max. (mΩ)			Ciss Typ.	V _{GS(th)} Max.	Q _g Typ. (nC)		Package	
			V	±V	A		10V	6V	4.5V	pF	V	10V	4.5V		
PJQ2460	N	Single	60	20	3.2	-	75	-	90	509	2.5	9.3	-	DFN2020B-6L	
PJQ2470A	N	Single	100	20	1.7	-	310	-	320	508	2.5	9.1	-		
PJQ2463A	P	Single	-60	20	-3.2	-	105	-	145	785	-2.5	10	-		
PJQ4460AP	N	Single	60	20	11	-	72	-	88	509	2.5	9.3	-	DFN3333-8L	
PJQ4464AP	N	Single	60	20	33	-	17	-	20	1574	2.5	-	13.5		
PJQ4466AP	N	Single	60	20	33	-	21	-	24	1680	2.5	28	-		
PJQ4468AP	N	Single	60	20	18	-	34	-	40	1173	2.5	20	-		
PJQ4476AP	N	Single	100	20	35	-	25	-	28.5	1519	2.5	31	-		
PJQ4463AP	P	Single	-60	20	-4.2	-	68	-	85	879	-2.5	17	-		
PJQ4465AP	P	Single	-60	20	-16	-	48	-	65	1256	-2.5	22	-		
PJQ4882AP	N/N	Dual	100	20	5.1	-	310	-	-	444	2.5	8.5	-	DFN3333B-8L	
PSMQC060N06LS1	N	Single	60	20	68	-	6	-	10	2057	3	37	19	DFN5060-8L	
PSMQC120N06LS1	N	Single	60	20	39	-	12	-	16	850	2.5	16	8.3		
PSMQC040N08NS2	N	Single	80	20	102	-	4	7	-	2300	3.8	36	-		
PSMQC042N10LS2	N	Single	100	20	112	-	4.2	-	6	3800	2.3	58	27		
PSMQC040N10NS2	N	Single	100	20	122	-	4.4	6.5	-	3010	3.8	40.5	-		
PSMQC074N10NS2	N	Single	100	20	67	-	7.4	12	-	1650	3.8	24	-		
PSMQC078N10LS2	N	Single	100	20	64	-	7.8	-	11.5	1970	2.3	30	14		
PSMQC094N10NS2	N	Single	100	20	61	-	9.4	15.4	-	1370	3.8	19	-		
PSMQC098N10LS2	N	Single	100	20	61	-	9.8	-	14	1610	2.3	25	11.6		
PSMQC280N10LS2	N	Single	100	20	21	-	28	-	39	525	2.3	9	4.4		
PSMQC076N12LS1	N	Single	115	20/-12	91.4	-	7.6	-	10.5	4740	4	77	-		
PJQ5468A	N	Single	60	20	25	-	34	-	40	1173	2.5	20	-		
PJQ5466A	N	Single	60	20	40	-	21	-	24	1680	2.5	28	-		
PJQ5466A1	N	Single	60	20	48	-	17	-	20	1574	2.5	-	13.5		
PJQ5462A	N	Single	60	20	42	-	12	-	15	2142	2.5	40	-		
PJQ5472A	N	Single	100	20	13	-	115	-	120	1413	2.5	20	-		
PJQ5474A	N	Single	100	20	18	-	50	-	55	3555	2.5	61	-		
PJQ5476AL	N	Single	100	20	42	-	25	-	28.5	1519	2.5	31	-		
PJQ5494	N	Single	150	20	40	-	35	-	-	2207	4	52	-		
PJQ5463A	P	Single	-60	20	-15	-	68	-	85	879	-2.5	17	-		
PJQ5465A	P	Single	-60	20	-16	-	48	-	65	1256	-2.5	22	-		
PJQ5866A	N/N	Dual	60	20	40	-	17	-	20	1574	2.5	-	13.5	DFN5060B-8L	
PJQ5882A	N/N	Dual	100	20	6.5	-	310	-	-	444	2.5	8.5	-		
PJW4N06A	N	Single	60	20	4	-	100	-	110	509	2.5	-	5.1	SOT-223	
PJW5N06A	N	Single	60	20	5	-	75	-	90	509	2.5	9.3	-		
PJW7N06A	N	Single	60	20	6.6	-	34	-	40	1173	2.5	20	-		
PJW3N10A	N	Single	100	20	2.2	-	310	-	320	508	2.5	9.1	-		
PJW5N10	N	Single	100	20	5	-	130	-	-	707	3.5	12	-		
PJW5N10A	N	Single	100	20	5	-	115	-	120	1413	2.5	20	-		
PJW3P06A	P	Single	-60	20	-3	-	190	-	240	430	-2.5	8.3	-		
PJW4P06A	P	Single	-60	20	-4	-	110	-	130	785	-2.5	10	-		
PJW5P06A	P	Single	-60	20	-5	-	68	-	85	879	-2.5	17	-		
PJW2P10A	P	Single	-100	20	-1.5	-	650	-	700	448	-2.5	8	-		
PJW3P10A	P	Single	-100	20	-2.6	-	210	-	230	1419	-3	20	-		
PJA3460	N	Single	60	20	2.5	-	75	-	90	509	2.5	9.3	-		SOT-23
PJA3470	N	Single	100	20	1.3	-	320	-	330	508	2.5	9.1	-		
PJA3461	P	Single	-60	20	-1.9	-	190	-	240	430	-2.5	8.3	-		
PJA3471	P	Single	-100	20	-1	-	650	-	700	448	-2.5	8	-		
PJS6461	P	Single	-60	20	-3.2	-	110	-	130	785	-2.5	10	-	SOT-23 6L	

Medium Voltage MOSFET

Part Number	Ch.	Config.	V _{DS}	V _{GS}	I _D	ESD	R _{DS(on)} Max. (mΩ)			Ciss Typ.	V _{GS(th)} Max.	Q _g Typ. (nC)		Package
			V	±V	A		10V	6V	4.5V	pF	V	10V	4.5V	
PSMD460N15NS1	N	Single	150	20	22	-	46	60	-	1315	3.2	20	-	TO-252AA
PJD11N06A	N	Single	60	20	11	-	75	-	90	509	2.5	9.3	-	
PJD16N06A	N	Single	60	20	16	-	50	-	60	815	2.5	14	-	
PJD25N06A	N	Single	60	20	25	-	34	-	40	1173	2.5	20	-	
PJD35N06A	N	Single	60	20	35	-	21	-	24	1680	2.5	28	-	
PJD40N06A	N	Single	60	20	40	-	17	-	20	1574	2.5	-	13.5	
PJD45N06A	N	Single	60	20	45	-	12	-	15	2256	2.5	39	-	
PJD6N10A	N	Single	100	20	6	-	310	-	320	508	2.5	9.1	-	
PJD9N10A	N	Single	100	20	9	-	152	-	158	1021	2.5	19	-	
PJD13N10A	N	Single	100	20	13	-	115	-	120	1413	2.5	20	-	
PJD25N10A	N	Single	100	20	25	-	50	-	55	3601	2.5	61	-	
PJD50N10AL	N	Single	100	20	42	-	25	-	28.5	1485	2.5	29	-	
PJD30N15	N	Single	150	25	25	-	65	-	-	1764	4	29.5	-	
PJD40N15	N	Single	150	20	40	-	35	-	-	2207	4	52	-	
PJD18N20	N	Single	200	20	18	-	160	-	-	1017	3	24	-	
PJD9P06A	P	Single	-60	20	-7	-	190	-	240	430	-2.5	8.3	-	
PJD12P06	P	Single	-60	20	-12	-	155	-	-	385	-4	10.9	-	
PJD14P06A	P	Single	-60	20	-14	-	110	-	130	785	-2.5	10	-	
PJD15P06A	P	Single	-60	20	-15	-	68	-	85	879	-2.5	17	-	
PJD16P06A	P	Single	-60	20	-16	-	48	-	65	1256	-2.5	22	-	
PJD10P10A	P	Single	-100	20	-10	-	210	-	230	1419	-3	20	-	
PJD14P10A	P	Single	-100	20	-14	-	140	-	170	2298	-3	40.7	-	
PSMN015N10NS2	N	Single	100	20	395	-	1.5	2	-	9640	3.8	128	-	TOLL
PSMN028N10NS2*	N	Single	100	20	240	-	2.8	4.2	-	4540	3.8	65	-	TO-263
PSMB033N10NS2*	N	Single	100	20	219	-	3.3	4.7	-	4710	3.8	65	-	
PSMB050N10NS2	N	Single	100	20	120	-	5	7	-	3010	3.8	40.5	-	TO-220AB-L
PSMP033N10NS2*	N	Single	100	20	219	-	3.3	4.7	-	4710	3.8	65	-	
PSMP050N10NS2	N	Single	100	20	120	-	5	7	-	3010	3.8	40.5	-	
PSMP110N10NS2*	N	Single	100	20	62	-	11	17	-	1230	3.8	18	-	TO-220AB
PSMP075N15NS1	N	Single	150	+20/-20	125	-	7.5	9	-	6511	4	97	-	
PJP18N20	N	Single	200	20	18	-	160	-	-	1017	3	24	-	ITO-220AB-F
PJF18N20	N	Single	200	20	18	-	160	-	-	1017	3	24	-	

*Under Development

Super Junction MOSFET

Part Number	Ch.	Config.	V _{DS}	V _{GS}	I _D	ESD	R _{DS(on)} Max. (Ω)	C _{iss} Typ.	V _{GS(th)} Max.	Q _g Typ. (nC)	Package
			V	±V	A		10V	pF	V	10V	
PJMD280N60E1	N	Single	600	30	13.8	-	0.28	926	4	27	TO-252AA
PJMD360N60EC	N	Single	600	30	11	-	0.36	735	4	18.7	
PJMD900N60EC	N	Single	600	30	5	-	0.9	310	4	8.8	
PJMD390N65EC	N	Single	650	30	10	-	0.39	726	4	19	
PJMD990N65EC	N	Single	650	30	4.7	-	0.99	306	4	9.7	
PJMB105N60FRC	N	Single	600	30	38	-	0.105	2995	5.8	60	TO-263
PJMB125N60FRC	N	Single	600	30	29	-	0.125	2490	5.8	49	
PJMB130N65EC	N	Single	650	30	29	-	0.13	1920	4	51	
PJMB210N65EC	N	Single	650	30	19	-	0.21	1412	4	34	
PJMB310N65EC	N	Single	650	30	13	-	0.31	940	4	24	
PJMB390N65EC	N	Single	650	30	10	-	0.39	726	4	19	ITO-220AB-F
PJMF099N60EC	N	Single	600	30	39	-	0.099	2568	4	60	
PJMF105N60FRC	N	Single	600	30	38	-	0.105	2995	5.8	60	
PJMF120N60EC	N	Single	600	30	30	-	0.12	1960	4	51	
PJMF125N60FRC	N	Single	600	30	29	-	0.125	2490	5.8	49	
PJMF190N60E1	N	Single	600	30	20	-	0.19	1336	4	36	
PJMF280N60E1	N	Single	600	30	15	-	0.28	941	4	25	
PJMF360N60EC	N	Single	600	30	11	-	0.36	735	4	18.7	
PJMF900N60E1	N	Single	600	30	4.5	-	0.9	337	4	9.6	
PJMF900N60EC	N	Single	600	30	5	-	0.9	310	4	8.8	
PJMF210N65EC	N	Single	650	30	19	-	0.21	1412	4	34	
PJMF130N65EC	N	Single	650	30	29	-	0.13	1920	4	51	
PJMF310N65EC	N	Single	650	30	13	-	0.31	940	4	24	
PJMF390N65EC	N	Single	650	30	10	-	0.39	726	4	19	
PJMF640N65EC	N	Single	650	30	7	-	0.64	462	4	13	
PJMF990N65EC	N	Single	650	30	4.7	-	0.99	306	4	9.7	TO-220AB-L
PJMP099N60EC	N	Single	600	30	39	-	0.099	2568	4	60	
PJMP105N60FRC	N	Single	600	30	38	-	0.105	2995	5.8	60	
PJMP120N60EC	N	Single	600	30	30	-	0.12	1960	4	51	
PJMP125N60FRC*	N	Single	600	30	29	-	0.125	2490	5.8	49	
PJMP190N60E1	N	Single	600	30	20.6	-	0.18	1410	3.8	40	
PJMP360N60EC	N	Single	600	30	11	-	0.36	735	4	18.7	
PJMP900N60EC	N	Single	600	30	5	-	0.9	310	4	8.8	
PJMP130N65EC	N	Single	650	30	29	-	0.13	1920	4	51	
PJMP210N65EC	N	Single	650	30	19	-	0.21	1412	4	34	
PJMP310N65EC	N	Single	650	30	13	-	0.31	940	4	24	
PJMP390N65EC	N	Single	650	30	10	-	0.39	726	4	19	
PJMP640N65EC	N	Single	650	30	7	-	0.64	462	4	13	
PJMP990N65EC	N	Single	650	30	4.7	-	0.99	306	4	9.7	
PJMH040N60EC	N	Single	600	30	74	-	0.04	6580	4	144	
PJMH042N60FRC*	N	Single	600	30	69	-	0.042	7400	5.8	145	
PJMH074N60FRCH	N	Single	600	30	53	-	0.074	3871	5.8	84	
PJMH099N60EC	N	Single	600	30	39	-	0.099	2568	4	60	
PJMH105N60FRC*	N	Single	600	30	38	-	0.105	2995	5.8	60	
PJMH120N60EC	N	Single	600	30	30	-	0.12	1960	4	51	
PJMH125N60FRC*	N	Single	600	30	29	-	0.125	2490	5.8	49	
PJMH190N60E1	N	Single	600	30	20.6	-	0.18	1410	3.8	40	

*Under Development

High Speed IGBT

Part Number	I_C	$V_{BR(CES)}$	$V_{ce(sat)}$ at I_F	E _{off}	IC pulse Max.	Diode I_F	Package
	A	V	V	mJ	A	A	
PTGH3065S1*	30	650	1.6	0.45	90	15	TO-247-3L
PTGH4065S1	40	650	1.65	0.39	120	20	
PTGH5065S1*	50	650	1.6	0.75	150	25	
PTGH6065S1*	60	650	1.6	0.92	180	30	
PTGH7565S1	75	650	1.65	1.27	225	37.5	
PTGH15120S1*	15	1200	2	1	45	8	
PTGH25120S1*	25	1200	2	1	75	15	
PTGH40120S1*	40	1200	2	1	120	30	

*Under Development

Medium Speed IGBT

Part Number	I_C	$V_{BR(CES)}$	$V_{ce(sat)}$ at I_F	E _{off}	IC pulse Max.	Diode I_F	Package
	A	V	V	mJ	A	A	
PTGH3065M1*	30	650	1.3	0.45	90	30	TO-247-3L
PTGH4065M1*	40	650	1.3	0.45	120	40	
PTGH5065M1*	50	650	1.3	0.45	150	50	
PTGH6065M1*	60	650	1.3	0.45	180	60	
PTGH7565M1*	75	650	1.3	0.45	225	75	
PTGH15120M1*	15	1200	1.6	0.675	45	15	
PTGH25120M1*	25	1200	1.6	0.675	75	25	
PTGH40120M1*	40	1200	1.6	0.675	120	40	

*Under Development

SiC Diodes

Part Number	V_{RRM}	I_F	$V_F@I_F$	$I_R@V_R$	P_D	Q_C	Package	
	V	A	V	μA	W	nC		
PCDD0465G1	650	4	1.5	40	46	6.4	TO-252AA	
PCDD0465GB	650	4	1.3	100	51	16		
PCDC0465G1	650	4	1.5	40	46	6.4		
PCDD0665G1	650	6	1.5	50	64.9	11.3		
PCDD0665GB	650	6	1.3	100	73	23		
PCDC0665G1	650	6	1.5	50	64.9	11.3		
PCDD0865G1	650	8	1.5	60	83.3	15.7		
PCDD0865GB	650	8	1.3	100	89	32		
PCDC0865G1	650	8	1.5	60	83.3	15.7		
PCDD1065G1	650	10	1.5	70	99.3	20		
PCDD1065GB	650	10	1.3	100	90	36		
PCDC1065G1	650	10	1.5	70	99.3	20		
PCDD05120G1	1200	5	1.5	50	120	17		
PCDC05120G1	1200	5	1.5	50	120	17		
PCDD08120G1	1200	8	1.5	60	156.3	32		
PCDC08120G1	1200	8	1.5	60	156.3	32		
PCDD10120G1	1200	10	1.5	100	200	42		
PCDC10120G1	1200	10	1.5	100	200	42		
PCDB0465G1	650	4	1.5	40	46	6.4		TO-263
PCDE0465G1	650	4	1.5	40	46	6.4		
PCDB0665G1	650	6	1.5	50	62.5	11.3		
PCDE0665G1	650	6	1.5	50	62.5	11.3		
PCDB0865G1	650	8	1.5	60	78.5	15.7		
PCDE0865G1	650	8	1.5	60	78.5	15.7		
PCDB1065G1	650	10	1.5	70	102.7	20		
PCDE1065G1	650	10	1.5	70	102.7	20		
PCDB10120G1	1200	10	1.5	100	164.8	42		
PCDE10120G1	1200	10	1.5	100	164.8	42		
PCDB20120G1	1200	20	1.5	180	267.9	87		
PCDE20120G1	1200	20	1.5	180	267.9	87		

SiC Diodes

Part Number	V_{RRM}	I_F	$V_F@I_F$	$I_R@V_R$	P_D	Q_C	Package
	V	A	V	μA	W	nC	
PCDP0465G1	650	4	1.5	40	56	6.4	TO-220AC
PCDP0465GB	650	4	1.3	40	50	17	
PCDP0665G1	650	6	1.5	50	57.7	11.3	
PCDP0665GB	650	6	1.3	50	65	24	
PCDP0865G1	650	8	1.5	60	71.1	15.7	
PCDP0865GB	650	8	1.3	60	79	32	
PCDP0865GC	650	8	1.5	40	50	17	
PCDP1065G1	650	10	1.5	70	83.3	20	
PCDP1065GB	650	10	1.3	70	94	39	
PCDP1065GC	650	10	1.5	50	65	24	
PCDP1265G1	650	12	1.5	80	102.7	25	
PCDP1265GB	650	12	1.3	80	107	47	
PCDP1265GC	650	12	1.5	60	79	32	
PCDP1665G1	650	16	1.5	100	136.4	34.9	
PCDP1665GB	650	16	1.3	100	125	61	
PCDP1665GC	650	16	1.5	70	94	39	
PCDP2065G1	650	20	1.5	120	153.1	43.5	
PCDP2065GB	650	20	1.3	120	150	77	
PCDP2065GC	650	20	1.5	80	107	47	
PCDP05120G1	1200	5	1.5	50	129.3	17	
PCDP08120G1	1200	8	1.5	60	135.1	32	
PCDP10120G1	1200	10	1.5	100	151.5	42	
PCDP15120G1	1200	15	1.5	140	223.9	67	
PCDP20120G1	1200	20	1.5	180	267.9	87	
PCDF0465G1	650	4	1.5	40	53.6	9.8	ITO-220AC
PCDF0665G1	650	6	1.5	50	70.8	14	
PCDF0865G1	650	8	1.5	60	78.1	18	
PCDF1065G1	650	10	1.5	70	104.2	22.4	TO-247AD-2LD
PCDH20120G1	1200	20	1.5	180	288.5	93.8	
PCDH2065CCG1	650	20	1.5	70	98	24	TO-247AD-3LD
PCDH2065CCGB	650	20	1.3	100	138	36	
PCDH2065CCGC	650	20	1.5	100	90	22	
PCDH3065CCG1	650	30	1.5	100	135.1	38	
PCDH3065CCGB	650	30	1.3	100	217	57	
PCDH3065CCGC	650	30	1.5	100	138	36	
PCDH4065CCG1	650	40	1.5	120	176.5	46.7	
PCDH4065CCGB	650	40	1.3	100	253	70	
PCDH4065CCGC	650	40	1.5	100	166	42	
PCDH20120CCG1	1200	20	1.5	100	164.8	47.6	
PCDH20120CCGB	1200	20	1.4	100	209	55	
PCDH30120CCG1	1200	30	1.5	140	230.8	72	
PCDH30120CCGB	1200	30	1.4	100	332	82	
PCDH40120CCG1	1200	40	1.5	180	294.1	90	
PCDH40120CCGB	1200	40	1.4	100	443	114	

Small Signal Schottky

Part Number	V _{RRM}	I _F	I _{FSM}	V _F @ I _F		I _R @V _R		C _J @V _R		Package
	V	A	A	V	mA	μA	V	pF	V	
SS0140Q	30	0.1	2	0.8	100	10	40	2	4	DFN0603-2L
SBA0520Q	20	0.5	2	0.48	500	100	20	25	4	DFN1006-2L
RB521S30FN2	30	0.2	2	0.51	200	30	30	15	0	
BAT54FN2	30	0.2	0.6	0.6	100	2	25	15	0	
SBA0530Q	30	0.5	2	0.52	500	100	30	20	4	
1SS417FN2	40	0.1	1	0.62	100	5	40	10	0	
SBA0540Q	40	0.5	2	0.6	500	50	40	15	4	
RB720M-30	30	0.1	1	0.35	10	0.5	10	15	0	SOD-923
BAT54TM	30	0.2	0.6	0.6	100	2	25	15	0	SOD-923
1SS417TM	45	0.1	1	0.62	50	5	40	15	0	
RB521S30	30	0.2	1	0.5	200	100	30	20	0	SOD-523
RB520S30	30	0.2	1	0.6	200	1	10	30	0	
BAT54TS	30	0.2	0.6	0.6	100	2	25	10	0	
RB751S40X	40	0.03	0.2	0.37	1	0.5	30	2.5	1	
BAS40TS	40	0.2	0.5	1	40	1	25	4	0	
RB520S40	40	0.25	1	0.6	200	5	30	50	0	
RB751S40	40	0.3	0.5	0.37	1	0.5	30	3	1	
1SS388	45	0.1	1	0.6	50	5	10	18	0	
MMBD717WS	20	0.2	-	0.37	1	1	10	3.5	0	SOD-323
SD103CWS	20	0.35	2	0.6	200	5	10	50	0	
SBA0820CS	20	0.8	2	0.55	800	100	20	25	4	
MMBD330WS	30	0.2	-	0.6	10	0.2	25	-	-	
SD107WS	30	0.2	0.75	0.8	100	1	25	3	10	
BAT54WS	30	0.2	1	0.6	100	2	25	10	0	
BAT42WS	30	0.2	4	1	200	0.5	30	4	0	
BAT43WS	30	0.2	4	1	200	0.5	30	-	-	
SD103BWS	30	0.35	2	0.6	200	5	20	50	0	
RB551V-30	30	0.5	5	0.47	500	100	20	60	0	
SBA0830CS	30	0.8	2	0.6	800	100	30	20	4	
RB751V-40X	40	0.03	0.2	0.37	1	0.5	30	2.5	1	
BAS40WS	40	0.2	4	1	40	10	40	4	0	
RB751V-40	40	0.3	0.6	0.37	1	0.5	30	3	1	
SD103AWS	40	0.35	2	0.6	200	5	30	50	0	
SBA0840CS	40	0.8	2	0.7	800	50	40	15	4	
SS0840WS	40	0.8	8	0.56	800	100	40	110	0	
RB500V-40	45	0.1	1	0.45	10	1	10	6	10	
RB501V-40	45	0.1	1	0.55	100	10	10	6	10	
BAS70WS	70	0.2	4	1	15	10	70	1.25	0	
BAS100CS	100	0.5	5.5	0.85	500	1	100	21	4	
SD103CW	20	0.35	2	0.6	200	5	10	50	0	SOD-123
SS0520	20	0.5	5.5	0.385	500	75	10	170	0	
SBA0820AS	20	0.8	2	0.55	800	100	20	25	4	
BAT42W	30	0.2	4	1	200	0.5	30	10	0	
BAT43W	30	0.2	4	1	200	0.5	30	10	0	
SD103BW	30	0.35	2	0.6	200	5	20	50	0	
SS0530	30	0.5	5.5	0.43	500	20	15	170	0	
SBA0830AS	30	0.8	2	0.6	800	100	30	20	4	
SD103AW	40	0.35	2	0.6	200	5	50	50	0	
SS0540	40	0.5	5.5	0.62	1000	10	20	170	0	
SBA0840AS	40	0.8	2	0.7	800	50	40	15	4	
BAS100AS	100	0.5	5.5	0.85	500	1	100	21	4	
BAT54RTB	30	0.2	0.6	0.6	100	2	25	10	0	SOT-523
BAT54TB	30	0.2	0.6	0.6	100	2	25	10	0	
BAT54ATB	30	0.2	0.6	0.6	100	2	25	10	0	
BAT54CTB	30	0.2	0.6	0.6	100	2	25	10	0	
BAT54STB	30	0.2	0.6	0.6	100	2	25	10	0	SOT-563
BAT54STB-TB6	30	0.2	0.6	0.6	100	2	25	10	0	
BAT54TB6	30	0.2	0.6	0.6	100	2	25	10	0	
BAT54CTB6	30	0.2	0.6	0.6	100	2	25	10	0	
SS0530TB6	30	0.5	6	0.5	500	5	15	132	0	
BAS100ATB6	100	0.4	5.5	0.81	400	1	100	21	4	

Small Signal Schottky

Part Number	V_{RRM}	I_F	I_{FSM}	$V_F @ I_F$ Max.		$I_R @ V_R$ Max.		$C_J @ V_R$ Typ.		Package
	V	A	A	V	mA	μA	V	pF	V	
MMBD717W	20	0.2	-	0.37	1	1	10	3.5	0	SOT-323
MMBD717AW	20	0.2	-	0.37	1	1	10	3.5	0	
MMBD717CW	20	0.2	-	0.37	1	1	10	3.5	0	
MMBD717SW	20	0.2	-	0.37	1	1	10	3.5	0	
PJRB461F	25	0.7	3	0.49	700	200	20	-	-	
MMBD330W	30	0.2	-	0.6	10	0.2	25	2.5	0	
BAT54W	30	0.2	0.6	0.6	100	2	25	10	0	
BAT54AW	30	0.2	0.6	0.6	100	2	25	10	0	
BAT54CW	30	0.2	0.6	0.6	100	2	25	10	0	
BAT54SW	30	0.2	0.6	0.6	100	2	25	10	0	
BAS40W	40	0.2	0.6	1	40	1	25	4	0	
BAS40AW	40	0.2	0.6	1	40	1	25	4	0	
BAS40CW	40	0.2	0.6	1	40	1	25	4	0	
BAS40SW	40	0.2	0.6	1	40	1	25	4	0	
BAS70W	70	0.2	0.6	1	15	10	70	1.25	0	
BAS70AW	70	0.2	0.6	1	15	10	70	1.25	0	
BAS70CW	70	0.2	0.6	1	15	10	70	1.25	0	
BAS70SW	70	0.2	0.6	1	15	10	70	1.25	0	
BAT54TW	30	0.2	0.6	0.6	100	2	25	10	0	
BAT54ADW	30	0.2	0.6	0.6	100	2	25	10	0	
BAT54CDW	30	0.2	0.6	0.6	100	2	25	10	0	
BAT54SDW	30	0.2	0.6	0.6	100	2	25	10	0	
BAT54DW	30	0.2	0.6	0.6	100	2	25	10	0	
BAT54BRW	30	0.2	0.6	0.6	100	2	25	10	0	
SS0115TW	15	0.1	1	0.5	100	20	10	40	0	
BAT54TWP	30	0.2	0.6	0.6	100	2	25	10	0	
RB731UTW	40	0.03	0.2	0.37	1	0.98	25	2	1	
BAS40TW	40	0.2	0.6	1	40	1	25	4	0	
BAS40ADW	40	0.2	0.6	1	40	1	25	4	0	
BAS40CDW	40	0.2	0.6	1	40	1	25	4	0	
BAS40SDW	40	0.2	0.6	1	40	1	25	4	0	
RB501V-40TW	45	0.1	1	0.55	100	10	10	20	0	
BAS70TW	70	0.2	0.6	1	15	0.1	50	1.25	0	
BAS70ADW	70	0.2	0.6	1	15	0.1	50	1.25	0	
BAS70CDW	70	0.2	0.6	1	15	0.1	50	1.25	0	
BAS70SDW	70	0.2	0.6	1	15	0.1	50	1.25	0	

Small Signal Schottky

Part Number	V_{RRM}	I_F	I_{FSM}	$V_F@ I_F$		$I_R@V_R$		$C_J@V_R$		Package	
	V	A	A	V	mA	μA	V	pF	V		
MMBD717	20	0.2	-	0.37	1	1	10	3.5	0	SOT-23	
MMBD717A	20	0.2	-	0.37	1	1	10	3.5	0		
MMBD717C	20	0.2	-	0.37	1	1	10	3.5	0		
MMBD717S	20	0.2	-	0.37	1	1	10	3.5	0		
SBA0520CA	20	0.5	2	0.48	500	100	20	30	4		
SBA0520SA	20	0.5	2	0.48	500	100	20	15	4		
RB551V-30TA	30	0.2	0.6	0.48	500	100	20	60	0		
RB551V-30TC	30	0.2	0.6	0.48	500	100	20	60	0		
MMBD301	30	0.2	-	0.6	10	0.2	25	3.5	0		
MMBD452	30	0.2	-	0.6	10	0.2	25	3.5	0		
BAT54	30	0.2	0.6	0.6	100	2	25	10	0		
BAT54A	30	0.2	0.6	0.6	100	2	25	10	0		
BAT54C	30	0.2	0.6	0.6	100	2	25	10	0		
BAT54S	30	0.2	0.6	0.6	100	2	25	10	0		
BAT30S	30	0.3	1	0.58	200	5	30	60	0		
SBA0530CA	30	0.5	2	0.52	500	100	30	20	4		
SBA0530SA	30	0.5	2	0.52	500	100	30	20	4		
BAT721C	40	0.2	1	0.55	200	15	30	40	0		
BAT721S	40	0.2	1	0.55	200	15	30	40	0		
SD103AW-TA	40	0.2	1	0.55	200	15	30	23	0		
BAS40	40	0.2	0.6	1	40	1	25	4	0		
BAS40A	40	0.2	0.6	1	40	1	25	4	0		
BAS40C	40	0.2	0.6	1	40	1	25	4	0		
BAS40S	40	0.2	0.6	1	40	1	25	4	0		
BAT721AC	40	0.4	1	0.65	400	50	40	7	4		
SBA0540CA	40	0.5	2	0.6	500	50	40	15	4		
SBA0540SA	40	0.5	2	0.6	500	50	40	25	4		
RB411D	40	0.5	3	0.5	500	30	10	16	10		
BAT400D	40	0.5	5.5	0.5	500	50	30	170	0		
BAT750	40	0.75	5.5	0.49	750	100	30	18	25		
BAS70	70	0.2	0.6	1	15	1	70	1.25	0		
BAS70A	70	0.2	0.6	1	15	1	70	1.25	0		
BAS70C	70	0.2	0.6	1	15	1	70	1.25	0		
BAS70S	70	0.2	0.6	1	15	1	70	1.25	0		
RB731U	40	0.03	0.2	0.37	1	0.98	25	2	1		SOT-23 6L
LMSD103C	20	0.35	15	0.7	200	5	10	50	0		ICRO-MELF
LMSD103B	30	0.35	15	0.7	200	5	20	50	0		
LMSD103A	40	0.35	15	0.7	200	5	30	50	0		
LLSD103C	20	0.35	15	0.7	200	5	10	50	0		MINI-MELF
LLSD103B	30	0.35	15	0.7	200	5	20	50	0		
LLSD103A	40	0.35	15	0.7	200	5	30	50	0		
LQSD103C	20	0.35	15	0.7	200	5	10	50	0	QUADRO-MELF	
LQSD103B	30	0.35	15	0.7	200	5	20	50	0		
LQSD103A	40	0.35	15	0.7	200	5	30	50	0		
SD103C	20	0.35	15	0.7	200	5	10	50	0	DO-35	
SD103B	30	0.35	15	0.7	200	5	20	50	0		
SD103A	40	0.35	15	0.7	200	5	30	50	0		

Power Schottky

Part Number	V_{RRM}	I_F	I_{FSM}	$V_F@I_F$		$I_R@V_R$		Package	
	V	A	A	Max.		Max.			
				V	A	μA	V		
SS1030HEWS	30	1	22	0.52	1	100	30	SOD-323HE	
SS1040HEWS	40	1	22	0.58	1	100	40		
MBR1040HEWS	40	1	22	0.58	1	50	40		
SB1A40CH	40	1.5	22	0.62	1.5	50	40		
SS1060VHEWS	60	1	22	0.6	1	100	60		
MBR1060HEWS	60	1	20	0.68	1	50	60		
SS2060HEWS	60	2	30	0.85	2	30	60		
MBR1020VL	20	1	45	0.34	1	600	20		
SS1020FL	20	1	40	0.55	1	30	20	SOD-123FL	
MBR1020LL	20	1	50	0.45	1	400	20		
SS2020FL	20	2	50	0.5	2	100	20		
SS1030FL	30	1	40	0.55	1	30	30		
SS2030FL	30	2	50	0.5	2	100	30		
MBR1040VL	40	1	40	0.36	1	450	40		
SS1040FL	40	1	40	0.55	1	30	40		
SS2040LL	40	2	50	0.45	2	500	40		
SS2040FL	40	2	50	0.5	2	100	40		
SS3040FL-F	40	2.4	80	0.55	3	500	40		
SS1060FL	60	1	40	0.7	1	30	60		
SS1060XFL	60	1	40	0.54	1	30	60		
SS2060FL	60	2	50	0.7	2	40	60		
MB2H60AL	60	2	50	0.75	2	3	60		
SS1090VFL	90	1	50	0.73	1	100	90		
SS10100FL	100	1	40	0.8	1	30	100		
SS20100FL	100	2	50	0.85	2	40	100		
SS10150FL	150	1	30	0.85	1	30	150		
SS10200FL	200	1	30	0.85	1	30	200		
SS3020HE	20	3	80	0.52	3	160	20		SOD-123HE
SS3030HE	30	3	80	0.52	3	160	30		
SS1040HE	40	1	30	0.55	1	30	40		
SS2040HE	40	2	50	0.55	2	100	40		
SS3040HE	40	3	80	0.52	3	160	40		
SS1060HE	60	1	30	0.7	1	30	60		
SS2060LHE	60	2	50	0.67	2	100	60		
SS3060HE	60	3	80	0.65	3	100	60		
SB3H60AH	60	3	80	0.7	3	5	60		
SS10100HE	100	1	30	0.8	1	30	100		
SS30100HE	100	3	80	0.8	3	20	100		
SS10150HE	150	1	30	0.85	1	30	150		
SS30150HE	150	3	80	0.86	3	20	150		
SB1200AH	200	1	30	0.85	1	1.8	200		
SS10200HE	200	1	30	0.85	1	30	200		
SS30200HE	200	3	80	0.86	3	20	200		
SB130AS	30	1	30	0.48	1	45	30	SOD-123	
SS1030	30	1	30	0.48	1	50	30		
SS1040	40	1	30	0.55	1	50	40		
SS1040L	40	1	25	0.45	1	220	40		
SS1060	60	1	30	0.7	1	30	60	SOT-23	
RB491D	25	1	3	0.45	1	200	20		

Power Schottky

Part Number	V_{RRM}	I_F	I_{FSM}	$V_F@I_F$ Max.		$I_R@V_R$ Max.		Package
	V	A	A	V	A	μA	V	
SB12AFC	20	1	30	0.5	1	200	20	SMAF-C
SB22AFC	20	2	50	0.5	2	100	20	
SB32AFC	20	3	80	0.5	3	100	20	
SB52AFC	20	5	100	0.54	5	100	20	
SB13AFC	30	1	30	0.5	1	200	30	
SB23AFC	30	2	50	0.5	2	100	30	
SB33AFC	30	3	80	0.5	3	100	30	
SB53AFC	30	5	100	0.54	5	100	30	
SB14AFC	40	1	30	0.5	1	200	40	
SB24AFC	40	2	50	0.5	2	100	40	
SB34AFC	40	3	80	0.5	3	100	40	
SB54AFC	40	5	100	0.54	5	100	40	
SB15AFC	50	1	30	0.7	1	100	50	
SB25UAFC	50	2	50	0.52	2	100	50	
SB25AFC	50	2	50	0.7	2	100	50	
SB35AFC	50	3	80	0.75	3	100	50	
SB16AFC	60	1	30	0.7	1	100	60	
SB26AFC	60	2	50	0.7	2	100	60	
MBR3H60AFC	60	3	80	0.7	3	5	60	
SB36AFC	60	3	80	0.75	3	100	60	
SB56AFC	60	5	100	0.66	5	100	60	
MBR5H60AFC	60	5	100	0.75	5	5	60	
MBR18AFC	80	1	30	0.8	1	50	80	
MBR28AFC	80	2	50	0.8	2	50	80	
MBR38AFC	80	3	80	0.8	3	50	80	
MBR19AFC	90	1	30	0.8	1	50	90	
MBR29AFC	90	2	50	0.8	2	50	90	
MBR39AFC	90	3	80	0.8	3	50	90	
MBR110AFC	100	1	30	0.8	1	50	100	
MBR210AFC	100	2	50	0.8	2	50	100	
MBR310AFC	100	3	80	0.8	3	50	100	
MBR115AFC	150	1	30	0.9	1	50	150	
MBR215AFC	150	2	50	0.9	2	50	150	
MBR315AFC	150	3	80	0.9	3	50	150	
MBR120AFC	200	1	30	0.9	1	50	200	
MBR220AFC	200	2	50	0.9	2	50	200	
MBR320AFC	200	3	80	0.9	3	50	200	

Power Schottky

Part Number	V_{RRM}	I_F	I_{FSM}	$V_F@I_F$		$I_R@V_R$		Package
	V			A	A	Max.	Max.	
SS12L	20	1	30	0.42	1	200	20	SMA
SS12	20	1	30	0.5	1	200	20	
SR22	20	2	50	0.5	2	200	20	
SX32	20	3	80	0.5	3	200	20	
SS13L	30	1	30	0.42	1	200	30	
SS13	30	1	30	0.5	1	200	30	
SR23	30	2	50	0.5	2	200	30	
SX33L	30	3	75	0.37	3	1000	30	
SX33	30	3	80	0.5	3	200	30	
SS14L	40	1	30	0.42	1	100	40	
SS14	40	1	30	0.5	1	200	40	
SR24	40	2	50	0.5	2	200	40	
BR24	40	2	50	0.7	2	50	40	
SX34	40	3	80	0.5	3	200	40	
BX34	40	3	80	0.7	3	50	40	
SS14AL	45	1	30	0.45	1	100	50	
BR24A	45	2	50	0.7	2	50	45	
BX34A	45	3	80	0.7	3	50	45	
SS15	50	1	30	0.7	1	100	50	
SR25U	50	2	50	0.52	2	100	50	
BR25	50	2	50	0.7	2	50	50	
BX35	50	3	80	0.74	3	50	50	
SX35	50	3	80	0.75	3	100	50	
SS16L	60	1	30	0.5	1	100	60	
SS16	60	1	30	0.7	1	100	60	
BR26	60	2	50	0.7	2	50	60	
BX36	60	3	80	0.74	3	50	60	
SX36	60	3	80	0.75	3	100	60	
MS18	80	1	30	0.8	1	1	80	
BR28	80	2	50	0.8	2	50	80	
BX38	80	3	80	0.8	3	50	80	
SS19L	90	1	40	0.68	1	80	90	
BR29	90	2	50	0.8	2	50	90	
BX39	90	3	80	0.8	3	50	90	
MS110	100	1	30	0.8	1	1	100	
BR210	100	2	50	0.8	2	50	100	
BX310	100	3	80	0.8	3	50	100	
SX1H15	150	1	30	0.85	1	0.5	150	
MS115	150	1	30	0.9	1	0.5	150	
BR215	150	2	50	0.9	2	50	150	
SX3H15	150	3	80	0.85	3	0.5	150	
BX315	150	3	80	0.9	3	50	150	
MS120	200	1	30	0.9	1	0.5	200	
BR220	200	2	50	0.9	2	50	200	
BX320	200	3	80	0.9	3	50	200	
SS12W	20	1	30	0.5	1	500	20	SMA(W)
SR22W	20	2	50	0.5	2	500	20	
SS13W	30	1	30	0.5	1	500	30	
SR23W	30	2	50	0.5	2	500	30	
SS14W	40	1	30	0.5	1	500	40	
SS15W	50	1	30	0.7	1	500	50	
SS16W	60	1	30	0.7	1	500	60	
SR26W	60	2	50	0.7	2	100	60	
SS18W	80	1	30	0.85	1	500	80	
SS19W	90	1	30	0.85	1	500	90	
S100W	100	1	30	0.85	1	500	100	
SK12F	20	1	30	0.5	1	100	20	SMBF
SK22F	20	2	50	0.5	2	100	20	
SR32F	20	3	80	0.5	3	100	20	
SK13F	30	1	30	0.5	1	100	30	
SK23F	30	2	50	0.5	2	100	30	
SR53F	30	5	100	0.55	5	100	30	

Power Schottky

Part Number	V_{RRM}	I_F	I_{FSM}	$V_F@I_F$ Max.		$I_R@V_R$ Max.		Package	
	V	A	A	V	A	μA	V		
SK14F	40	1	30	0.5	1	100	40	SMBF	
SK24F	40	2	50	0.5	2	100	40		
SR34LF	40	3	100	0.46	3	100	40		
SR34F	40	3	80	0.5	3	100	40		
SK54BLF	40	5	100	0.46	5	100	40		
SR54F	40	5	100	0.55	5	100	40		
SK15F	50	1	30	0.7	1	100	50		
SK25F	50	2	50	0.7	2	100	50		
SR55F	50	5	100	0.7	5	100	50		
SK16F	60	1	30	0.7	1	100	60		
SK26F	60	2	50	0.7	2	100	60		
SR36F	60	3	80	0.75	3	100	60		
SR56F	60	5	100	0.7	5	100	60		
MB18F	80	1	30	0.8	1	50	80		
MB28F	80	2	50	0.8	2	50	80		
BR38F	80	3	80	0.8	3	50	80		
MB19F	90	1	30	0.8	1	50	90		
MB29F	90	2	50	0.8	2	50	90		
BR39F	90	3	80	0.8	3	50	90		
MB110F	100	1	30	0.8	1	50	100		
MB210F	100	2	50	0.8	2	50	100		
BR310F	100	3	80	0.8	3	50	100		
MB115F	150	1	30	0.9	1	50	150		
MB215F	150	2	50	0.9	2	50	150		
BR315F	150	3	80	0.9	3	50	150		
MB120F	200	1	30	0.9	1	50	200		
MB220F	200	2	50	0.9	2	50	200		
BR320F	200	3	80	0.9	3	50	200		
SRC4200UF	200	4	100	0.84	4	1	200		
SK12	20	1	30	0.5	1	200	20		SMB
SK22	20	2	50	0.5	2	90	20		
SR32	20	3	80	0.5	3	200	20		
SK13	30	1	30	0.5	1	200	30		
SK23L	30	2	50	0.45	2	250	30		
SK23	30	2	50	0.5	2	90	30		
SR33	30	3	80	0.5	3	200	30		
SK14	40	1	30	0.5	1	200	40		
MB14	40	1	30	0.7	1	50	40		

Power Schottky

Part Number	V_{RRM}	I_F	I_{FSM}	$V_F@I_F$ Max.		$I_R@V_R$ Max.		Package	
	V	A	A	V	A	μA	V		
SK24L	40	2	50	0.45	2	250	40	SMB	
SK24	40	2	50	0.5	2	90	40		
MB24	40	2	50	0.7	2	50	40		
SR34	40	3	80	0.5	3	200	40		
BR34	40	3	80	0.7	3	50	40		
SK54BL	40	5	100	0.46	5	100	40		
MB14A	45	1	30	0.7	1	50	45		
MB24A	45	2	50	0.7	2	50	45		
BR34A	45	3	80	0.7	3	50	45		
SK15	50	1	30	0.7	1	100	50		
MB15	50	1	30	0.74	1	50	50		
SK25	50	2	50	0.7	2	90	50		
MB25	50	2	50	0.74	2	50	50		
BR35	50	3	80	0.74	3	50	50		
SK16	60	1	30	0.7	1	100	60		
MB16	60	1	30	0.74	1	50	60		
SK26L	60	2	50	0.52	2	150	60		
SK26	60	2	50	0.7	2	90	60		
MB26	60	2	50	0.74	2	50	60		
BR36	60	3	80	0.74	3	50	60		
MBR3H60MB	60	3	100	0.7	3	5	60		
MB18	80	1	30	0.8	1	50	80		
MB28	80	2	50	0.8	2	50	80		
BR38	80	3	80	0.8	3	50	80		
MB19	90	1	30	0.8	1	50	90		
MB29	90	2	50	0.8	2	50	90		
BR39	90	3	80	0.8	3	50	90		
MB110	100	1	30	0.8	1	50	100		
MB210	100	2	50	0.8	2	50	100		
BR310V	100	3	120	0.74	3	50	100		
BR310	100	3	80	0.8	3	50	100		
BR810	100	8	150	0.8	8	50	100		
MB115	150	1	30	0.9	1	50	150		
MB215	150	2	50	0.9	2	50	150		
BR315	150	3	80	0.9	3	50	150		
SR5H15	150	5	150	0.85	5	0.5	150		
BR515L	150	5	100	0.86	5	15	150		
MB120	200	1	30	0.9	1	50	200		
MB220	200	2	50	0.9	2	50	200		
BR320	200	3	80	0.9	3	50	200		
SK32	20	3	100	0.5	3	200	20		SMC
SK52	20	5	100	0.55	5	200	20		
SK33	30	3	100	0.5	3	200	30		
SK53	30	5	100	0.55	5	200	30		
SK34	40	3	100	0.5	3	200	40		
MB34	40	3	100	0.7	3	50	40		
SK44L	40	4	150	0.44	4	200	40		
SK54L	40	5	100	0.44	5	500	40		
SK54	40	5	100	0.55	5	200	40		
MB54	40	5	100	0.7	5	50	40		
SK84	40	8	150	0.55	8	500	40		
MB34A	45	3	100	0.7	3	50	45		
MB54A	45	5	100	0.7	5	50	45		
MB35	50	3	100	0.74	3	50	50		
SK35	50	3	100	0.75	3	100	50		
MB55	50	5	100	0.74	5	50	50		
SK55	50	5	100	0.75	5	100	50		
MB36	60	3	100	0.74	3	50	60		
SK36	60	3	100	0.75	3	100	60		

Power Schottky

Part Number	V_{RRM}	I_F	I_{FSM}	$V_F@I_F$ Max.		$I_R@V_R$ Max.		Package	
	V	A	A	V	A	μA	V		
SK56L	60	5	100	0.5	5	500	60	SMC	
MB56	60	5	100	0.74	5	50	60		
SK56	60	5	100	0.75	5	100	60		
MB38	80	3	100	0.8	3	50	80		
MB58	80	5	100	0.8	5	50	80		
MB39	90	3	100	0.8	3	50	90		
MB59	90	5	100	0.8	5	50	90		
MB310	100	3	100	0.8	3	50	100		
MB510	100	5	100	0.8	5	50	100		
S510L	100	5	250	0.7	5	50	100		
MB810	100	8	150	0.8	8	50	100		
MB315	150	3	100	0.9	3	50	150		
MB515	150	5	100	0.9	5	50	150		
MB320	200	3	100	0.9	3	50	200		
MB420L	200	4	100	0.86	4	5	200		
MB520	200	5	100	0.9	5	50	200		
SB340YD*	40	3	80	0.54	3	200	40		TO-252AA
SB640CD*	40	2 x 3	80	0.54	3	200	40		
SB1040CD*	40	2 x 5	120	0.55	5	200	40		
SB540YD*	40	5	120	0.55	5	200	40		
SB840YD*	40	8	170	0.55	8	200	40		
MBR1045CD*	45	2 x 5	130	0.6	5	50	45		
MBR1045YD*	45	10	185	0.6	10	50	45		
SB1060YD*	60	10	170	0.73	10	200	60		
MBR1060CD*	60	2 x 5	120	0.74	5	50	60		
MBR560YD*	60	5	120	0.74	5	50	60		
SB360YD*	60	3	80	0.68	3	100	60		
SB660CD*	60	2 x 3	80	0.68	3	100	60		
SB1060CD*	60	2 x 5	120	0.69	5	100	60		
SB560YD*	60	5	120	0.69	5	100	60		
MBR2060YD	60	20	150	0.77	20	50	60		
MBR6100CD*	100	2 x 3	80	0.8	3	50	100		
MBR10100CD*	100	2 x 5	120	0.8	5	50	100		
MBR5100YD*	100	5	120	0.8	5	50	100		
MBR8100YD*	100	8	145	0.8	8	50	100		
MBR10H150CD*	150	2 x 5	120	0.85	5	5	150		
MBR5H150YD*	150	5	120	0.85	5	5	150		
MBR20H150YD	150	20	275	0.9	20	0.8	150		
MBR6200CD*	200	2 x 3	80	0.87	3	50	200		
MBR10200CD*	200	2 x 5	120	0.87	5	50	200		
MBR5200YD*	200	5	120	0.87	5	50	200		
MBR8200YD*	200	8	150	0.87	8	50	200		
SV540B	40	5	150	0.52	5	250	40	TO-277B	
SV1580VB	80	15	250	0.72	15	100	80		
SV5100B	100	5	150	0.87	5	15	100		
SVC10120VB	120	10	200	0.79	10	100	120		
SVC12120VB	120	12	200	0.77	12	100	100		
SVC4200VB	200	4	100	0.84	4	1	200		
MBR8H120PC	120	8	160	0.87	8	1	120	TO-277C	
MBR15H120PC	120	15	210	0.87	15	1	120		
MBR5H150PC	150	5	150	0.85	5	0.5	150		
MBR10H150PC	150	10	200	0.85	10	0.55	150		
SV540	40	5	150	0.52	5	250	40	TO-277	
SV1040	40	10	300	0.51	10	700	40		
SV560L	60	5	120	0.67	5	150	60		
SV1580V	80	15	250	0.72	15	100	80		
SV5100	100	5	150	0.87	5	15	100		
SVC10120V	120	10	200	0.79	10	100	120		
SVC12120V	120	12	200	0.77	12	100	100		
SVC4200V	200	4	100	0.84	4	1	200		

*Under Development

Power Schottky

Part Number	V_{RRM}	I_F	I_{FSM}	$V_F@I_F$		$I_R@V_R$		Package
	V	A	A	Max.		Max.		
				V	A	μA	V	
SB1020DC	20	2 x 5	150	0.55	5	200	20	TO-263
SB1620DC	20	2 x 8	150	0.55	8	200	20	
SB820DC	20	2 x 4	150	0.55	4	200	20	
SB820D	20	8	150	0.55	8	200	20	
SB830DC	30	2 x 4	150	0.55	4	200	30	
SB830D	30	8	150	0.55	8	200	30	
SB1030DC	30	2 x 5	150	0.55	5	200	30	
SB1630DC	30	2 x 8	150	0.55	8	200	30	
SB840DC	40	2 x 4	150	0.55	4	200	40	
MBR840DC	40	2 x 4	150	0.7	4	50	40	
SB840D	40	8	150	0.55	8	200	40	
MBR840D	40	8	150	0.7	8	50	40	
SB1040DC	40	2 x 5	150	0.55	5	200	40	
MBR1040DC	40	2 x 5	150	0.7	5	50	40	
SB1640DC	40	2 x 8	150	0.55	8	200	40	
MBR1640DC	40	2 x 8	150	0.7	8	50	40	
MBR2040DC	40	2 x 10	200	0.7	10	50	40	
SB4040LDC	40	2 x 20	250	0.5	20	400	40	
MBR845DC	45	2 x 4	150	0.7	4	50	45	
MBR845D	45	8	150	0.7	8	50	45	
MBR1045DC	45	2 x 5	150	0.7	5	50	45	
MBR1645DC	45	2 x 8	150	0.7	8	50	45	
MBR2045DC	45	2 x 10	200	0.7	10	50	45	
MBR850DC	50	2 x 4	150	0.75	4	50	50	
MBR850D	50	8	150	0.75	8	50	50	
MBR1050DC	50	2 x 5	150	0.75	5	50	50	
MBR1650DC	50	2 x 8	150	0.75	8	50	50	
MBR2050DC	50	2 x 10	200	0.75	10	50	50	
MBR860DC	60	2 x 4	150	0.75	4	50	60	
MBR860D	60	8	150	0.75	8	50	60	
MBR1060DC	60	2 x 5	150	0.75	5	50	60	
MBR1660DC	60	2 x 8	150	0.75	8	50	60	
MBR2060DC	60	2 x 10	200	0.75	10	50	60	
MBR880DC	80	2 x 4	150	0.8	4	50	80	
MBR880D	80	8	150	0.8	8	50	80	
MBR1080DC	80	2 x 5	150	0.8	5	50	80	
MBR1680DC	80	2 x 8	150	0.8	8	50	80	
MBR2080DC	80	2 x 10	200	0.8	10	50	80	
MBR890DC	90	2 x 4	150	0.8	4	50	90	
MBR890D	90	8	150	0.8	8	50	90	
MBR1090DC	90	2 x 5	150	0.8	5	50	90	
MBR1690DC	90	2 x 8	150	0.8	8	50	90	
MBR2090DC	90	2 x 10	200	0.8	10	50	90	
MBR8100DC	100	2 x 4	150	0.8	4	50	100	
MBR8100D	100	8	150	0.8	8	50	100	
MBR10100DC	100	2 x 5	150	0.8	5	50	100	
MBR16100DC	100	2 x 8	150	0.8	8	50	100	
MBR20100DC	100	2 x 10	200	0.8	10	50	100	
MBR8150DC	150	2 x 4	150	0.9	4	50	150	
MBR8150D	150	8	150	0.9	8	50	150	
MBR10H150DC	150	2 x 5	120	0.85	5	0.5	150	
MBR10150DC	150	2 x 5	150	0.9	5	50	150	
MBR16150DC	150	2 x 8	150	0.9	8	50	150	
MBR20H150DC	150	2 x 10	200	0.85	10	0.55	150	
MBR20150DC	150	2 x 10	200	0.9	10	50	150	
MBR30H150DC	150	2 x 15	275	0.85	15	0.8	150	
MBR8200DC	200	2 x 4	150	0.9	4	50	200	
MBR8200D	200	8	150	0.9	8	50	200	
MBR10200DC	200	2 x 5	150	0.9	5	50	200	
MBR16200DC	200	2 x 8	150	0.9	8	50	200	
MBR20200DC	200	2 x 10	200	0.9	10	50	200	

Power Schottky

Part Number	V_{RRM}	I_F	I_{FSM}	$V_F@I_F$		$I_R@V_R$		Package
	V	A	A	Max.		Max.		
				V	A	μA	V	
SB620CT	20	2 x 3	75	0.55	3	200	20	TO-220AB
SB1020CT	20	2 x 5	150	0.55	5	200	20	
SB2020CT	20	2 x 10	200	0.55	10	200	20	
SB3020CT	20	2 x 15	275	0.55	15	200	20	
SB820CT	20	2 x 4	150	0.55	4	200	20	
SB1620CT	20	2 x 8	150	0.55	8	200	20	
SB2520CT	20	2 x 12.5	200	0.55	12.5	200	20	
SB630CT	30	2 x 3	75	0.55	3	200	30	
SB830CT	30	2 x 4	150	0.55	4	200	30	
SB1030CT	30	2 x 5	150	0.55	5	200	30	
SB1630CT	30	2 x 8	150	0.55	8	200	30	
SB2030CT	30	2 x 10	200	0.55	10	200	30	
SB2530CT	30	2 x 12.5	200	0.55	12.5	200	30	
SB3030CT	30	2 x 15	275	0.55	15	200	30	
SB640CT	40	2 x 3	75	0.55	3	200	40	
MBR640CT	40	2 x 3	75	0.7	3	50	40	
SB840CT	40	2 x 4	150	0.55	4	200	40	
MBR840CT	40	2 x 4	150	0.7	4	50	40	
SB1040CT	40	2 x 5	125	0.44	5	500	40	
SB1040CT	40	2 x 5	150	0.55	5	200	40	
MBR1040CT	40	2 x 5	150	0.7	5	50	40	
SB1640CT	40	2 x 8	150	0.55	8	200	40	
MBR1640CT	40	2 x 8	150	0.7	8	50	40	
SB2040CT	40	2 x 10	200	0.55	10	200	40	
MBR2040CT	40	2 x 10	200	0.7	10	50	40	
MBR2540CT	40	2 x 12.5	200	0.7	12.5	50	40	
SB2540CT	40	2 x 12.5	200	0.55	12.5	200	40	
SB3040CT	40	2 x 15	275	0.55	15	200	40	
MBR3040CT	40	2 x 15	275	0.7	15	100	40	
MBR645CT	45	2 x 3	75	0.7	3	50	45	
SB845CT	45	2 x 4	150	0.55	4	100	45	
MBR845CT	45	2 x 4	150	0.7	4	50	45	
MBR1045CT	45	2 x 5	150	0.7	5	50	45	
SB1645CT	45	2 x 8	150	0.55	8	100	45	
MBR1645CT	45	2 x 8	150	0.7	8	50	45	
SB2045CT	45	2 x 10	200	0.55	10	200	45	
MBR2045CT	45	2 x 10	200	0.7	10	50	45	
SB2545CT	45	2 x 12.5	200	0.55	12.5	200	45	
MBR2545CT	45	2 x 12.5	200	0.7	12.5	50	45	
SB3045CT	45	2 x 15	275	0.55	15	200	45	
MBR3045CT	45	2 x 15	275	0.7	15	100	45	
SB4045LCT	45	2 x 20	250	0.53	20	500	45	
MBR650CT	50	2 x 3	75	0.75	3	50	50	
SB650CT	50	2 x 3	75	0.7	3	100	50	
MBR850CT	50	2 x 4	150	0.75	4	50	50	
MBR1650CT	50	2 x 8	150	0.75	8	50	50	
MBR1050CT	50	2 x 5	150	0.75	5	50	50	
MBR2050CT	50	2 x 10	200	0.75	10	50	50	
MBR2550CT	50	2 x 12.5	200	0.75	12.5	50	50	
MBR3050CT	50	2 x 15	275	0.75	15	100	50	
SB660CT	60	2 x 3	75	0.7	3	100	60	
MBR660CT	60	2 x 3	75	0.75	3	50	60	
MBR860CT	60	2 x 4	150	0.75	4	50	60	
MBR1060CT	60	2 x 5	150	0.75	5	50	60	
MBR1660CT	60	2 x 8	150	0.75	8	50	60	
MBR2060CT	60	2 x 10	200	0.75	10	50	60	
MBR2560CT	60	2 x 12.5	200	0.75	12.5	50	60	
MBR3060CT	60	2 x 15	275	0.75	15	100	60	

Power Schottky

Part Number	V_{RRM}	I_F	I_{FSM}	$V_F@I_F$		$I_R@V_R$		Package
	V	A	A	Max.		Max.		
				V	A	μA	V	
MBR680CT	80	2 x 3	75	0.8	3	50	80	TO-220AB
MBR880CT	80	2 x 4	150	0.8	4	50	80	
MBR1080CT	80	2 x 5	150	0.8	5	50	80	
MBR1680CT	80	2 x 8	150	0.8	8	50	80	
MBR2080CT	80	2 x 10	200	0.8	10	50	80	
MBR2580CT	80	2 x 12.5	200	0.8	12.5	50	80	
MBR3080CT	80	2 x 15	275	0.8	15	100	80	
MBR690CT	90	2 x 3	75	0.8	3	50	90	
MBR890CT	90	2 x 4	150	0.8	4	50	90	
MBR1090CT	90	2 x 5	150	0.8	5	50	90	
MBR1690CT	90	2 x 8	150	0.8	8	50	90	
MBR2090CT	90	2 x 10	200	0.8	10	50	90	
MBR2590CT	90	2 x 12.5	200	0.8	12.5	50	90	
MBR3090CT	90	2 x 15	275	0.8	15	100	90	
MBR6100CT	100	2 x 3	75	0.8	3	50	100	
MBR8100CT	100	2 x 4	150	0.8	4	50	100	
MBR10100CT	100	2 x 5	150	0.8	5	50	100	
MBR16100CT	100	2 x 8	150	0.8	8	50	100	
MBR20100CT	100	2 x 10	200	0.8	10	50	100	
MBR25100CT	100	2 x 12.5	200	0.8	12.5	50	100	
MBR30100CT	100	2 x 15	275	0.8	15	50	100	
SB30100LYT	100	30	275	1	30	200	100	
MBRL10100CT*	100	2 x 5	150	0.8	5	50	100	
MBRL20100CT*	100	2 x 10	250	0.8	10	50	100	
MBRL30100CT*	100	2 x 15	275	0.8	15	50	100	
MBR6150CT	150	2 x 3	75	0.9	3	50	150	
MBR8150CT	150	2 x 4	150	0.9	4	50	150	
MBR10H150CT	150	2 x 5	120	0.85	5	0.5	150	
MBR10150CT	150	2 x 5	150	0.9	5	50	150	
MBR16150CT	150	2 x 8	150	0.9	8	50	150	
MBR20H150CT	150	2 x 10	200	0.85	10	0.55	150	
MBR20150CT	150	2 x 10	200	0.9	10	50	150	
MBR30H150CT	150	2 x 15	275	0.85	15	0.8	150	
MBR30150CT	150	2 x 15	275	0.9	15	50	150	
MBR25150CT	150	2 x 12.5	200	0.9	12.5	50	150	
MBRL10150CT*	150	2 x 5	150	0.9	5	50	150	
MBRL20150CT*	150	2 x 10	250	0.9	10	50	150	
MBRL30150CT*	150	2 x 15	275	0.9	15	50	150	
MBR6200CT	200	2 x 3	75	0.9	3	50	200	
MBR8200CT	200	2 x 4	150	0.9	4	50	200	
MBR10200CT	200	2 x 5	150	0.9	5	50	200	
MBR16200CT	200	2 x 8	150	0.9	8	50	200	
MBR20200CT	200	2 x 10	200	0.9	10	50	200	
MBR25200CT	200	2 x 12.5	200	0.9	12.5	50	200	
MBR30200CT	200	2 x 15	275	0.9	15	50	200	
MBRL10200CT*	200	2 x 5	150	0.9	5	50	200	
MBRL20200CT*	200	2 x 10	250	0.9	10	50	200	

*Under Development

Power Schottky

Part Number	V_{RRM}	I_F	I_{FSM}	$V_F@I_F$ Max.		$I_R@V_R$ Max.		Package
	V	A	A	V	A	μA	V	
SB620	20	6	75	0.55	6	200	20	TO-220AC
SB820	20	8	150	0.55	8	200	20	
SB1020	20	10	150	0.55	10	200	20	
SB630	30	6	75	0.55	6	200	30	
SB830	30	8	150	0.55	8	200	30	
SB1030	30	10	150	0.55	10	200	30	
SB640	40	6	75	0.55	6	200	40	
MBR640	40	6	75	0.7	6	50	40	
MBR840	40	8	150	0.7	8	50	40	
SB840	40	8	150	0.55	8	200	40	
SB1040	40	10	150	0.55	10	200	40	
MBR1040	40	10	150	0.7	10	50	40	
SB2040	40	20	275	0.55	20	100	40	
MBR645	45	6	75	0.7	6	50	45	
SB845	45	8	150	0.55	8	100	45	
MBR845	45	8	150	0.7	8	50	45	
SB1045	45	10	150	0.55	10	200	45	
MBR1045	45	10	150	0.7	10	50	45	
MBR1545	45	15	280	0.64	15	50	45	
MBR3045	45	30	250	0.7	30	100	45	
MBR650	50	6	75	0.75	6	50	50	
SB650	50	6	75	0.7	6	200	50	
MBR850	50	8	150	0.75	8	50	50	
MBR1050	50	10	150	0.75	10	50	50	
SB660	60	6	75	0.7	6	200	60	
MBR660	60	6	75	0.75	6	50	60	
MBR860	60	8	150	0.75	8	50	60	
MBR1060	60	10	150	0.75	10	50	60	
SBM1060L	60	10	150	0.57	10	220	60	
MBR1560	60	15	280	0.75	15	50	60	
MBR680	80	6	75	0.8	6	50	80	
MBR880	80	8	150	0.8	8	50	80	
MBR1080	80	10	150	0.8	10	50	80	
MBR690	90	6	75	0.8	6	50	90	
MBR890	90	8	150	0.8	8	50	90	
MBR1090	90	10	150	0.8	10	50	90	
MBR6100	100	6	75	0.8	6	50	100	
MBR8100	100	8	150	0.8	8	50	100	
MBR10100	100	10	150	0.8	10	50	100	
MBR6150	150	6	75	0.9	6	50	150	
MBR8150	150	8	150	0.9	8	50	150	
MBR10150	150	10	150	0.9	10	50	150	
MBR6200	200	6	75	0.9	6	50	200	
MBR8200	200	8	150	0.9	8	50	200	
MBR10200	200	10	150	0.9	10	50	200	

Power Schottky

Part Number	V_{RRM}	I_F	I_{FSM}	$V_F@I_F$		$I_R@V_R$		Package
	V	A	A	Max.		Max.		
				V	A	μA	V	
SB620FCT	20	2 x 3	75	0.55	3	200	20	ITO-220AB
SB1020FCT	20	2 x 5	150	0.55	5	200	20	
SB1620FCT	20	2 x 8	150	0.55	8	200	20	
SB2020FCT	20	2 x 10	200	0.55	10	200	20	
SB2520FCT	20	2 x 12.5	200	0.55	12.5	200	20	
SB3020FCT	20	2 x 15	275	0.55	15	200	20	
SB630FCT	30	2 x 3	75	0.55	3	200	30	
SB820FCT	20	2 x 4	150	0.55	4	200	20	
SB830FCT	30	2 x 4	150	0.55	4	200	30	
SB1030FCT	30	2 x 5	150	0.55	5	200	30	
SB1630FCT	30	2 x 8	150	0.55	8	200	30	
SB2030FCT	30	2 x 10	200	0.55	10	200	30	
SB2530FCT	30	2 x 12.5	200	0.55	12.5	200	30	
SB3030FCT	30	2 x 15	275	0.55	15	200	30	
SB640FCT	40	2 x 3	75	0.55	3	200	40	
MBR640FCT	40	2 x 3	75	0.7	3	50	40	
SB840FCT	40	8	150	0.55	4	200	40	
MBR840FCT	40	2 x 4	150	0.7	4	50	40	
SB1040LFCT	40	2 x 5	125	0.44	5	500	40	
SB1040FCT	40	2 x 5	150	0.55	5	200	40	
MBR1040FCT	40	2 x 5	150	0.7	5	50	40	
SB1640FCT	40	2 x 8	150	0.55	8	200	40	
MBR1640FCT	40	2 x 8	150	0.7	8	50	40	
SB2040FCT	40	2 x 10	200	0.55	10	200	40	
MBR2040FCT	40	2 x 10	200	0.7	10	50	40	
SB2540FCT	40	2 x 12.5	200	0.55	12.5	200	40	
MBR2540FCT	40	2 x 12.5	200	0.7	12.5	50	40	
SB3040FCT	40	2 x 15	275	0.55	15	200	40	
MBR3040FCT	40	2 x 15	275	0.7	15	100	40	
MBR645FCT	45	2 x 3	75	0.7	3	50	45	
SB845FCT	45	2 x 4	150	0.55	4	100	45	
MBR845FCT	45	2 x 4	150	0.7	4	50	45	
MBR1045FCT	45	2 x 5	150	0.7	5	50	45	
SB1645FCT	45	2 x 8	150	0.55	8	100	45	
MBR1645FCT	45	2 x 8	150	0.7	8	50	45	
SB2045FCT	45	2 x 10	200	0.55	10	200	45	
MBR2045FCT	45	2 x 10	200	0.7	10	50	45	
SB2545FCT	45	2 x 12.5	200	0.55	12.5	100	45	
MBR2545FCT	45	2 x 12.5	200	0.7	12.5	50	45	
SB3045LFCT	45	2 x 15	250	0.53	15	400	45	
SB3045FCT	45	2 x 15	275	0.55	15	200	45	
MBR3045FCT	45	2 x 15	275	0.7	15	100	45	
MBR650FCT	50	2 x 3	75	0.75	3	50	50	
SB650FCT	50	2 x 3	75	0.7	3	100	50	
MBR850FCT	50	2 x 4	150	0.75	4	50	50	
MBR1050FCT	50	2 x 5	150	0.75	5	50	50	
MBR1650FCT	50	2 x 8	150	0.75	8	50	50	
MBR2050FCT	50	2 x 10	200	0.75	10	50	50	
MBR2550FCT	50	2 x 12.5	200	0.75	12.5	50	50	
MBR3050FCT	50	2 x 15	275	0.75	15	100	50	

Power Schottky

Part Number	V _{RRM}	I _F	I _{FSM}	V _F @I _F Max.		I _R @V _R Max.		Package
	V	A	A	V	A	μA	V	
SB660FCT	60	2 x 3	75	0.7	3	100	60	ITO-220AB
MBR660FCT	60	2 x 3	75	0.75	3	50	60	
MBR860FCT	60	2 x 4	150	0.75	4	50	60	
MBR1060FCT	60	2 x 5	150	0.75	5	50	60	
MBR1660FCT	60	2 x 8	150	0.75	8	50	60	
MBR2060FCT	60	2 x 10	200	0.75	10	50	60	
MBR2560FCT	60	2 x 12.5	200	0.75	12.5	50	60	
MBR3060FCT	60	2 x 15	275	0.75	15	100	60	
MBR680FCT	80	2 x 3	75	0.8	3	50	80	
MBR880FCT	80	2 x 4	150	0.8	4	50	80	
MBR1080FCT	80	2 x 5	150	0.8	5	50	80	
MBR1680FCT	80	2 x 8	150	0.8	8	50	80	
MBR2080FCT	80	2 x 10	200	0.8	10	50	80	
MBR2580FCT	80	2 x 12.5	200	0.8	12.5	50	80	
MBR3080FCT	80	2 x 15	275	0.8	15	100	80	
MBR690FCT	90	2 x 3	75	0.8	3	50	90	
MBR890FCT	90	2 x 4	150	0.8	4	50	90	
MBR1090FCT	90	2 x 5	150	0.8	5	50	90	
MBR1690FCT	90	2 x 8	150	0.8	8	50	90	
MBR2090FCT	90	2 x 10	200	0.8	10	50	90	
MBR2590FCT	90	2 x 12.5	200	0.8	12.5	50	90	
MBR3090FCT	90	2 x 15	275	0.8	15	100	90	
MBR6100FCT	100	2 x 3	75	0.8	3	50	100	
MBR8100FCT	100	2 x 4	150	0.8	4	50	100	
MBR10100FCT	100	2 x 5	150	0.8	5	50	100	
MBR16100FCT	100	2 x 8	150	0.8	8	50	100	
MBR20100FCT	100	2 x 10	200	0.8	10	50	100	
MBR25100FCT	100	2 x 12.5	200	0.8	12.5	50	100	
MBR30100FCT	100	2 x 15	275	0.8	15	50	100	
SB30100LFYT	100	30	275	1	30	200	100	
MBRL10100FCT*	100	2 x 5	150	0.8	5	50	100	
MBRL20100FCT*	100	2 x 10	250	0.8	10	50	100	
MBRL30100FCT*	100	2 x 15	275	0.8	15	50	100	
MBR6150FCT	150	2 x 3	75	0.9	3	50	150	
MBR8150FCT	150	2 x 4	150	0.9	4	50	150	
MBR10H150FCT	150	2 x 5	120	0.85	5	0.5	150	
MBR10150FCT	150	2 x 5	150	0.9	5	50	150	
MBR16150FCT	150	2 x 8	150	0.9	8	50	150	
MBR20H150FCT	150	2 x 10	200	0.85	10	0.55	150	
MBR20150FCT	150	2 x 10	200	0.9	10	50	150	
MBR25150FCT	150	2 x 12.5	200	0.9	12.5	50	150	
MBR30H150FCT	150	2 x 15	275	0.85	15	0.8	150	
MBR30150FCT	150	2 x 15	275	0.9	15	50	150	
MBRL10150FCT*	150	2 x 5	150	0.9	5	50	100	
MBRL20150FCT*	150	2 x 10	250	0.9	10	50	100	
MBRL30150FCT*	150	2 x 15	275	0.9	15	50	100	
MBR6200FCT	200	2 x 3	75	0.9	3	50	200	
MBR8200FCT	200	2 x 4	150	0.9	4	50	200	
MBR10200FCT	200	2 x 5	150	0.9	5	50	200	
MBR16200FCT	200	2 x 8	150	0.9	8	50	200	
MBR20200FCT	200	2 x 10	200	0.9	10	50	200	
MBR25200FCT	200	2 x 12.5	200	0.9	12.5	50	200	
MBR30200FCT	200	2 x 15	275	0.9	15	50	200	
MBRL10200FCT*	200	2 x 5	150	0.9	5	50	200	
MBRL20200FCT*	200	2 x 10	250	0.9	10	50	200	

*Under Development

Power Schottky

Part Number	V_{RRM}	I_F	I_{FSM}	$V_F@I_F$ Max.		$I_R@V_R$ Max.		Package
	V	A	A	V	A	μA	V	
SB620F	20	6	75	0.55	6	200	20	ITO-220AC
SB820F	20	8	150	0.55	8	200	20	
SB1020F	20	10	150	0.55	10	200	20	
SB630F	30	6	75	0.55	6	200	30	
SB830F	30	8	150	0.55	8	200	30	
SB1030F	30	10	150	0.55	10	200	30	
SB640F	40	6	75	0.55	6	200	40	
MBR640F	40	6	75	0.7	6	50	40	
MBR840F	40	8	150	0.7	8	50	40	
SB840F	40	8	150	0.55	8	200	40	
SB1040F	40	10	150	0.55	10	200	40	
MBR1040F	40	10	150	0.7	10	50	40	
MBR645F	45	6	75	0.7	6	50	45	
MBR845F	45	8	150	0.7	8	50	45	
SB845F	45	8	150	0.55	8	200	45	
SB1045F	45	10	150	0.55	10	100	45	
MBR1045F	45	10	150	0.7	10	50	45	
SB650F	50	6	75	0.7	6	100	50	
MBR650F	50	6	75	0.75	6	50	50	
MBR850F	50	8	150	0.75	8	50	50	
MBR1050F	50	10	150	0.75	10	50	50	
SB660F	60	6	75	0.7	6	100	60	
MBR660F	60	6	75	0.75	6	50	60	
MBR860F	60	8	150	0.75	8	50	60	
MBR1060F	60	10	150	0.75	10	50	60	
MBR680F	80	6	75	0.8	6	50	80	
MBR880F	80	8	150	0.8	8	50	80	
MBR1080F	80	10	150	0.8	10	50	80	
MBR690F	90	6	75	0.8	6	50	90	
MBR890F	90	8	150	0.8	8	50	90	
MBR1090F	90	10	150	0.8	10	50	90	
MBR6100F	100	6	75	0.8	6	50	100	
MBR8100F	100	8	150	0.8	8	50	100	
MBR10100F	100	10	150	0.8	10	50	100	
MBR6150F	150	6	75	0.9	6	50	150	
MBR8150F	150	8	150	0.9	8	50	150	
MBR10150F	150	10	150	0.9	10	50	150	
MBR6200F	200	6	75	0.9	6	50	200	
MBR8200F	200	8	150	0.9	8	50	200	
MBR10200F	200	10	150	0.9	10	50	200	

Power Schottky

Part Number	V_{RRM}	I_F	I_{FSM}	$V_F@I_F$ Max.		$I_R@V_R$ Max.		Package
	V	A	A	V	A	μA	V	
SB3020PT	20	2 x 15	275	0.55	15	200	20	TO-3P/TO-247AD
SB4020PT	20	2 x 20	350	0.55	20	200	20	
SB3030PT	30	2 x 15	275	0.55	15	200	30	
SB4030PT	30	2 x 20	350	0.55	20	200	30	
SB3040PT	40	2 x 15	275	0.55	15	200	40	
MBR3040PT	40	2 x 15	275	0.7	15	100	40	
SB4040PT	40	2 x 20	350	0.55	20	200	40	
MBR4040PT	40	2 x 20	350	0.7	20	100	40	
MBR6040PT	40	2 x 30	400	0.7	30	100	40	
SB3045PT	45	2 x 15	275	0.55	15	200	45	
MBR3045PT	45	2 x 15	275	0.7	15	100	45	
SB4045PT	45	2 x 20	350	0.55	20	200	45	
MBR4045PT	45	2 x 20	350	0.7	20	100	45	
SB6045PT	45	2 x 30	500	0.55	30	250	45	
MBR6045PT	45	2 x 30	400	0.7	30	100	45	
SB3050PT	50	2 x 15	275	0.7	15	200	50	
MBR3050PT	50	2 x 15	275	0.75	15	100	50	
SB4050PT	50	2 x 20	350	0.7	20	200	50	
MBR4050PT	50	2 x 20	350	0.79	20	100	50	
MBR6050PT	50	2 x 30	400	0.79	30	100	50	
MBR3060PT	60	2 x 15	275	0.75	15	100	60	
SB3060PT	60	2 x 15	275	0.7	15	200	50	
SB4060PT	60	2 x 20	350	0.7	20	200	60	
MBR4060PT	60	2 x 20	350	0.79	20	100	60	
MBR6060PT	60	2 x 30	400	0.79	30	100	60	
MBR3080PT	80	2 x 15	275	0.8	15	100	80	
MBR4080PT	80	2 x 20	350	0.8	20	100	80	
MBR6080PT	80	2 x 30	400	0.8	30	100	80	
MBR3090PT	90	2 x 15	275	0.8	15	100	90	
MBR4090PT	90	2 x 20	350	0.8	20	100	90	
MBR6090PT	90	2 x 30	400	0.8	30	100	90	
MBR30100PT	100	2 x 15	275	0.8	15	50	100	
MBR40100PT	100	2 x 20	350	0.8	20	50	100	
MBR60100PT	100	2 x 30	400	0.8	30	50	100	
MBR30150PT	150	2 x 15	275	0.9	15	50	150	
MBR40150PT	150	2 x 20	350	0.9	20	50	150	
MBR60150PT	150	2 x 30	400	0.9	30	50	150	
MBR30200PT	200	2 x 15	275	0.9	15	50	200	
MBR40200PT	200	2 x 20	350	0.9	20	50	200	
MBR60200PT	200	2 x 30	400	0.9	30	50	200	

Power Schottky

Part Number	V_{RRM}	I_F	I_{FSM}	$V_F@I_F$ Max.		$I_R@V_R$ Max.		Package	
	V	A	A	V	A	μA	V		
SB220	20	2	50	0.5	2	200	20	DO-15	
SB230	30	2	50	0.5	2	200	30		
SB240	40	2	50	0.5	2	200	40		
MBR240	40	2	50	0.7	2	50	40		
SB340LS	40	3	150	0.46	3	60	40		
MBR245	45	2	50	0.7	2	50	45		
SB250	50	2	50	0.7	2	100	50		
MBR250	50	2	50	0.74	2	50	50		
SB260	60	2	50	0.7	2	100	60		
MBR260	60	2	50	0.74	2	50	60		
MBR280	80	2	50	0.8	2	50	80		
MBR290	90	2	50	0.8	2	50	90		
MBR2100	100	2	50	0.8	2	50	100		
MBR2150	150	2	50	0.9	2	50	150		
MBR2200	200	2	50	0.9	2	50	200		
1N5817	20	1	25	0.47	1	200	20		DO-41
SB120	20	1	30	0.5	1	200	20		
SB220S	20	2	50	0.5	2	500	20		
1N5818	30	1	25	0.55	1	200	30		
SB130	30	1	30	0.5	1	200	30		
SB230S	30	2	50	0.5	2	500	30		
1N5819	40	1	25	0.6	1	200	40		
SB140	40	1	30	0.5	1	200	40		
SB140L	40	1	90	0.45	1	100	40		
SB240S	40	2	50	0.5	2	500	40		
SB145L	45	1	90	0.45	1	100	50		
SB150	50	1	30	0.7	1	100	50		
SB250S	50	2	50	0.7	2	500	50		
SB160	60	1	30	0.7	1	100	60		
SB160L	60	1	90	0.5	1	100	60		
SB260S	60	2	50	0.7	2	500	60		
MBR180	80	1	30	0.8	1	50	80		
SB280S	80	2	50	0.85	2	500	80		
MBR190	90	1	30	0.8	1	50	90		
MBR1100	100	1	30	0.8	1	50	100		
SB2100S	100	2	50	0.85	2	500	100		
MBR1H150	150	1	30	0.85	1	0.5	150		
MBR1150	150	1	30	0.9	1	50	150		
MBR1200	200	1	30	0.9	1	50	200		
SB320	20	3	80	0.5	3	200	20	DO-201AD	
SB520	20	5	150	0.55	5	200	20		
SB330	30	3	80	0.5	3	200	30		
SB530	30	5	150	0.55	5	200	30		
SB340	40	3	80	0.5	3	200	40		
MBR340	40	3	80	0.7	3	50	40		
MBR540	40	5	150	0.7	5	50	40		

Power Schottky

Part Number	V_{RRM}	I_F	I_{FSM}	$V_F@I_F$ Max.		$I_R@V_R$ Max.		Package	
	V	A	A	V	A	μA	V		
SB540L	40	5	150	0.49	5	200	40	DO-201AD	
MBR345	45	3	80	0.7	3	50	45		
MBR545	45	5	150	0.7	5	50	45		
MBR350	50	3	80	0.74	3	50	50		
SB350	50	3	80	0.75	3	100	50		
MBR550	50	5	150	0.74	5	50	50		
MBR360	60	3	80	0.74	3	50	60		
SB360	60	3	80	0.75	3	100	60		
MBR560	60	5	150	0.74	5	50	60		
SB560L	60	5	150	0.49	5	500	60		
MBR380	80	3	80	0.8	3	50	80		
MBR580	80	5	150	0.8	5	50	80		
MBR390	90	3	80	0.8	3	50	90		
MBR590	90	5	150	0.8	5	50	90		
MBR3100	100	3	80	0.8	3	50	100		
SB3100L	100	3	200	0.74	3	50	100		
MBR5100	100	5	150	0.8	5	50	100		
SB5100L	100	5	250	0.7	5	50	100		
MBR3150	150	3	80	0.9	3	50	150		
MBR3H150SS	150	3	80	0.85	3	0.5	150		
MBR5150	150	5	150	0.9	5	50	150		
MBR5H150SS	150	5	150	0.85	5	0.5	150		
MBR3200	200	3	80	0.9	3	50	200		
MBR5200	200	5	150	0.9	5	50	200		
SB1545S	45	15	275	0.5	15	200	45		P-600

Super Schottky

Part Number	V_{RRM}	I_F	I_{FSM}	$V_F@I_F$ Max.		$I_R@V_R$ Max.		Package
	V	A	A	V	A	μA	V	
SBA130Q	30	1	10	0.47	1	100	30	DFN1610-2L
SBA140Q	40	1	10	0.51	1	100	40	
SBA120CH	20	1	10	0.45	1	100	20	SOD-323HE
SBA220CH	20	2	20	0.46	2	100	20	
SBA130CH	30	1	10	0.47	1	100	30	
SBA230CH	30	2	20	0.48	2	100	30	
SBA140CH	40	1	10	0.51	1	100	40	
SBA240CH	40	2	20	0.53	2	100	40	
SBA120CS	20	1	8	0.45	1	100	20	SOD-323
SBA130CS	30	1	8	0.47	1	100	30	
SBA140CS	40	1	8	0.51	1	100	40	
SBA220AL	20	2	30	0.46	2	100	20	SOD-123FL
SBA320AL	20	3	50	0.44	3	200	20	
SBA230AL	30	2	30	0.49	2	100	30	
SBA330AL	30	3	50	0.46	3	200	30	
SBA240AL	40	2	30	0.53	2	100	40	
SBA340AL	40	3	50	0.48	3	150	40	
SBM260VAL	60	2	50	0.54	2	50	60	SOD-123
SBA120AS	20	1	10	0.45	1	100	20	
SBA130AS	30	1	10	0.47	1	100	30	
SBA140AS	40	1	10	0.51	1	100	40	
SBA220AH	20	2	30	0.46	2	100	20	
SBA320AH	20	3	50	0.44	3	200	20	
SBA230AH	30	2	30	0.49	2	100	30	SOD-123HE
SBA330AH	30	3	50	0.46	3	200	30	
SBA240AH	40	2	30	0.53	2	100	40	
SBA340AH	40	3	50	0.48	3	150	40	
SSM3060VHE	60	3	80	0.5	3	220	60	SMAF-C
SBA320AFC	20	3	50	0.44	3	200	20	
SBA520AFC	20	5	80	0.45	5	300	20	
SBA330AFC	30	3	50	0.46	3	200	30	
SBA530AFC	30	5	80	0.46	5	300	30	
SBA340AFC	40	3	50	0.48	3	150	40	
SBA540AFC	40	5	80	0.49	5	250	40	
SBM34AVAF	45	3	80	0.47	3	210	45	
SBM54ALAF	45	5	80	0.54	5	210	45	
SBT55LAF	50	5	80	0.5	5	100	50	
SBM36VAF	60	3	80	0.5	3	220	60	
SBM56LAF	60	5	80	0.6	5	220	60	
SXM345AV	45	3	80	0.47	3	60	45	SMA
SXM36V	60	3	80	0.5	3	220	60	
SRM54AVF	45	5	150	0.43	5	210	45	SMBF
SRM54ALF	45	5	120	0.49	5	210	45	
SRM84ALF	45	8	150	0.49	8	210	45	
SBM360VBF	60	3	80	0.5	3	220	60	
SRM560VF	60	5	120	0.52	5	220	60	
SRM860VF	60	8	150	0.55	8	220	60	
SRT8100UF	100	8	150	0.66	8	80	100	
SRM54AV	45	5	120	0.49	5	210	45	SMB

Super Schottky

Part Number	V _{RRM}	I _F	I _{FSM}	V _F @I _F Max.		I _R @V _R Max.		Package	
	V	A	A	V	A	μA	V		
SVM1045VA	45	10	275	0.47	10	250	45	TO-277A	
SVM1550UA	50	15	275	0.49	15	320	50		
SVM845LB	45	8	150	0.5	8	250	45	TO-277B	
SVM1045V2B	45	10	275	0.44	10	220	45		
SVM1045VB	45	10	275	0.47	10	250	45		
SVM1545LB	45	15	275	0.49	15	320	45		
SVM1550UB	50	15	275	0.49	15	320	50		
SVM1550VB	50	15	280	0.51	15	320	50		
SVM860UB	60	8	200	0.53	8	250	60		
SVM860VB	60	8	150	0.55	8	220	60		
SVM1060UB	60	10	250	0.52	10	220	60		
SVM1060XB	60	10	275	0.49	10	360	60		
SVT1560VB	60	15	300	0.51	15	250	60		
SVM1560UB	60	15	300	0.56	15	320	60		
SVM1560VB	60	15	250	0.59	15	200	60		
SVT2060LB	60	20	300	0.55	20	150	60		
SVT8100VB	100	8	150	0.67	8	50	100		
SVT10100UB	100	10	150	0.67	10	60	100		
SVT12100VB	100	12	200	0.67	12	100	100		
SVT15100UB	100	15	250	0.66	15	80	100		
SVT20100UB	100	20	250	0.66	20	80	100		
SVT10120VB	120	10	150	0.8	10	25	120		
SVT15120UB	120	15	250	0.79	15	35	120		
SVT20120UB	120	20	250	0.79	20	35	120		
SVT12120UB	120	12	200	0.79	12	25	120		
SVM845L	45	8	150	0.5	8	250	45		TO-277
SVM1045V2	45	10	275	0.44	10	220	45		
SVM1045V	45	10	275	0.47	10	250	45		
SVM1545L	45	15	275	0.49	15	320	45		
SVM1550U	50	15	275	0.49	15	320	50		
SVM1550V	50	15	280	0.51	15	320	50		
SVM860U	60	8	200	0.53	8	250	60		
SVM860V	60	8	150	0.55	8	220	60		
SVM1060X	60	10	275	0.49	10	360	60		
SVM1060U	60	10	250	0.52	10	220	60		
SVT1560V	60	15	300	0.51	15	250	60		
SVM1560U	60	15	300	0.56	15	320	60		
SVM1560V	60	15	250	0.59	15	200	60		
SVT2060L	60	20	300	0.55	20	150	60		
SVT8100V	100	8	150	0.67	8	50	100		
SVT10100U	100	10	150	0.67	10	60	100		
SVT12100V	100	12	200	0.67	12	100	100		
SVT15100U	100	15	250	0.66	15	80	100		
SVT20100U	100	20	250	0.66	20	80	100		
SVT10120V	120	10	150	0.8	10	25	120		
SVT12120U	120	12	200	0.79	12	25	120		
SVT15120U	120	15	250	0.79	15	35	120		
SVT20120U	120	20	250	0.79	20	35	120		
SBM1045VDC	45	2 x 5	150	0.46	5	250	45	TO-263	
SBM2045VDC	45	2 x 10	280	0.45	10	320	45		
SBM3045VDC	45	2 x 15	300	0.48	15	320	45		
SBM4045LDC	45	2 x 20	300	0.51	20	320	45		
SBM1060VDC	60	2 x 5	120	0.52	5	220	60		
SBM1660VDC	60	2 x 8	150	0.55	8	220	60		
SBM2060VDC	60	2 x 10	150	0.57	10	220	60		
SBM3060VDC	60	2 x 15	250	0.59	15	220	60		

Super Schottky

Part Number	V_{RRM}	I_F	I_{FSM}	$V_F@I_F$ Max.		$I_R@V_R$ Max.		Package
	V	A	A	V	A	μA	V	
SBM1045VCT	45	2 x 5	150	0.46	5	250	45	TO-220AB
SBM2045VCT	45	2 x 10	280	0.45	10	320	45	
SBM3045VCT	45	2 x 15	300	0.48	15	320	45	
SBM1060VCT	60	2 x 5	120	0.52	5	220	60	
SBM1660VCT	60	2 x 8	150	0.55	8	220	60	
SBM2060VCT	60	2 x 10	150	0.57	10	220	60	
SBM3060UCT	60	2 x 15	250	0.56	15	500	60	
SBM3060VCT	60	2 x 15	250	0.59	15	220	60	
SBM4060CT	60	2 x 20	250	0.7	20	220	60	
SBT10120LCT	120	2 x 5	80	0.83	5	20	120	
SBT20120LCT	120	2 x 10	150	0.82	10	20	120	
SBT30120LCT	120	2 x 15	200	0.84	15	30	120	
SBM1045VFCT	45	2 x 5	150	0.46	5	250	45	ITO-220AB
SBM2045VFCT	45	2 x 10	280	0.45	10	320	45	
SBM1060VFCT	60	2 x 5	120	0.52	5	220	60	
SBM1660VFCT	60	2 x 8	150	0.55	8	220	60	
SBM2060VFCT	60	2 x 10	150	0.57	10	220	60	
SBM3060VFCT	60	2 x 15	250	0.59	15	220	60	
SBT10120UFCT	120	2 x 5	150	0.75	5	20	120	
SBT10120LFCT	120	2 x 5	80	0.83	5	20	120	
SBT20120LFCT	120	2 x 10	150	0.82	10	20	120	
SBT30120LFCT	120	2 x 15	200	0.84	15	30	120	
SBM3060VPT	60	2 x 15	250	0.59	15	220	60	TO-3P/TO-247AD
SBM345VMS	45	3	80	0.47	3	60	45	DO-15
SBM245L	45	2	50	0.47	2	40	45	DO-41
SBM250L	50	2	50	0.5	2	40	50	
SBM545LSS	45	5	120	0.49	5	210	45	DO-201AD
SBM845LSS	45	8	150	0.5	8	250	45	
SBM1045VSS	45	10	200	0.47	10	300	45	
SBT1545LSS	45	15	275	0.46	15	310	45	
SBM1550USS	50	15	300	0.49	15	320	50	
SBM560VSS	60	5	120	0.52	5	220	60	
SBM860VSS	60	8	150	0.55	8	220	60	
SBM1060LSS	60	10	120	0.54	10	220	60	
SBM1560LSS	60	15	150	0.57	15	220	60	
SBT3100XSS	100	3	50	0.6	3	100	20	
SBT5100LSS	100	5	80	0.7	5	20	100	
SBT1045LS	45	10	275	0.51	10	50	45	P-600
SBT1545LS	45	15	275	0.46	15	310	45	
SBT1550VS	50	15	275	0.51	15	50	50	
SBT1560VS	60	15	300	0.53	15	50	60	

Small Signal Switching Diodes

Part Number	V_{RRM}	P_{TO}	t_{rr} Max.	$I_{FSM}@t_p$		$V_F@I_F$ Max.		$I_R@V_R$ Max.		C_j Max.	Package
	V	mW	ns	A	ms	V	mA	μA	V	pF	
1SS387FN2	85	300	1.6 typ.	2.3	10	1.2	100	0.5	80	0.5 typ.	DFN1006-2L
1SS400	90	200	4	4	0.001	1.2	100	0.1	80	3	SOD-523
MMBD914TS	100	200	4	4	0.001	1	10	5	75	4	
MMBD4148TS	100	200	4	4	0.001	1.25	150	2.5	75	1.5	
BAS16TS	100	200	6	4	0.001	0.855	10	1	75	2	
BAS116WS	100	200	3000	4	0.001	1.25	150	0.005	75	2	SOD-323
1N4148WS	100	250	4	4	0.001	1.25	150	2.5	75	1.5	
BAS316	100	400	4	4	0.001	1.25	150	0.5	100	1.5	
BAV19WS	120	200	50	4	0.001	1	100	0.1	100	5	
BAV20WS	200	200	50	4	0.001	1	100	0.1	150	5	
BAV21WS	250	200	50	4	0.001	1	100	0.1	200	5	
1N4148WSG	100	410	4	4	0.001	1.25	150	2.5	75	1.5	SOD-323S
BAV16W	100	350	6	4	0.001	0.855	10	1	75	2	SOD-123
1N4148W	100	410	4	4	0.001	1.25	150	2.5	75	1.5	
1N4448W	100	500	4	4	0.001	1	100	2.5	75	4	
BAV19W	120	410	50	4	1	1	100	0.1	100	5	
BAV20W	200	410	50	4	1	1	100	0.1	150	5	
BAV21W	250	410	50	4	1	1	100	0.1	200	5	
BAV3004W	350	410	50	1	1000	1.25	200	0.1	240	5	
BAL99TB	100	200	4	4	0.001	1.25	150	2.5	75	1.5	SOT-523
BAV70TB	100	200	4	4	0.001	1.25	150	2.5	75	1.5	
BAV99TB	100	200	4	4	0.001	1.25	150	2.5	75	1.5	
BAW56TB	100	200	4	4	0.001	1.25	150	2.5	75	1.5	
BAV170TB	100	250	3000	4	0.001	1	10	0.005	75	2	
BAV199TB	100	250	3000	4	0.001	1	10	0.005	75	2	
BAW156TB	100	250	3000	4	0.001	1	10	0.005	75	2	
BAS116TB	100	250	3000	4	0.001	1	10	0.005	75	2	SOT-563
BAS16VTB6	100	200	4	4	0.001	1.25	150	2.5	75	1.5	
BAV99STB6	100	200	4	4	0.001	1.25	150	2.5	75	1.5	
BAW56E6	100	200	4	4	0.001	1.25	150	0.5	100	1.5	
BAV199STB6	100	200	3000	2	0.001	1.25	150	0.005	75	2	SOT-323
MMBD6100W	80	200	4	4	0.001	1.1	100	0.1	50	2.5	
BAL99W	100	200	4	4	0.001	1.25	150	2.5	75	1.5	
BAV70W	100	200	4	4	0.001	1.25	150	2.5	75	1.5	
BAV99W	100	200	4	4	0.001	1.25	150	2.5	75	1.5	
BAW56W	100	200	4	4	0.001	1.25	150	2.5	75	1.5	
BAS16W	100	200	6	4	0.001	0.855	10	1	75	2	
MMBD4148W	100	200	4	4	0.001	1.25	150	2.5	75	1.5	
MMBD4448W	100	200	4	4	0.001	1	100	2.5	75	4	
MMBD7000W	100	200	4	4	0.001	1.1	100	3	100	2	
BAS19W	120	200	50	4	0.001	1	100	0.1	100	5	
BAS20W	200	200	50	4	0.001	1	100	0.1	150	5	
BAS21W	250	200	50	4	0.001	1	100	0.1	200	5	
BAV170W	100	200	3000	4	0.001	1.25	150	0.005	75	2	
BAV199W	100	200	3000	4	0.001	1.25	150	0.005	75	2	

Small Signal Switching Diodes

Part Number	V_{RRM}	P_{TO}	t_{rr} Max.	$I_{FSM}@t_p$		$V_F@I_F$ Max.		$I_R@V_R$ Max.		C_j Max.	Package
	V	mW	ns	A	ms	V	mA	μA	V	pF	
BAV99BRW	75	200	4	4	0.001	1.25	150	2.5	75	2	SOT-363
BAS16TW	100	200	4	4	0.001	1.25	150	2.5	75	1.5	
BAV70DW	100	200	4	4	0.001	1.25	150	2.5	75	1.5	
BAV99S	100	200	4	4	0.001	1.25	150	2.5	75	1.5	
BAW56DW	100	200	4	4	0.001	1.25	150	2.5	75	1.5	
MMBD4448TW	100	200	4	4	0.001	1	100	2.5	75	4	
BAS116TW	100	200	3000	4	0.001	1.25	150	0.005	75	2	
BAV199S	100	200	3000	4	0.001	1.25	150	0.005	75	2	
MMBD6050	80	225	4	4	0.001	1.1	100	0.1	50	2.5	
MMBD6100	80	225	4	4	0.001	1.1	100	0.1	50	2.5	
MMBD7000	100	225	4	4	0.001	1.1	100	3	100	2	
MMBD914	100	225	4	4	0.001	1	10	5	75	4	
BAL99	100	250	4	4	0.001	1.25	150	2.5	75	1.5	
BAV70	100	250	4	4	0.001	1.25	150	2.5	75	1.5	
BAV99	100	250	4	4	0.001	1.25	150	2.5	75	1.5	
BAW56	100	250	4	4	0.001	1.25	150	2.5	75	1.5	
MMBD4148	100	250	4	4	0.001	1.25	150	2.5	75	1.5	
MMBD4448	100	250	4	4	0.001	1	100	2.5	75	4	
BAS116	100	250	3000	4	0.001	1.25	150	0.005	75	2	
BAV170	100	250	3000	4	0.001	1.25	150	0.005	75	2	
BAV199	100	250	3000	4	0.001	1.25	150	0.005	75	2	
BAW156	100	250	3000	4	0.001	1.25	150	0.005	75	2	
BAS16	100	350	6	2	0.001	0.855	10	1	75	2	
BAS19	120	350	50	2.5	0.001	1	100	0.1	100	1.5	
BAS20	200	350	50	2.5	0.001	1	100	0.1	150	1.5	
BAS21	250	350	50	2.5	0.001	1	100	0.1	200	1.5	
BAS21A	250	250	50	4	0.001	1	100	0.1	200	5	
BAS21C	250	250	50	4	0.001	1	100	0.1	200	5	
BAS21S	250	250	50	4	0.001	1	100	0.1	200	5	
MMBD3004A	350	410	50	1	1000	1.25	200	0.1	350	5	
MMBD3004C	350	410	50	1	1000	1.25	200	0.1	350	5	
MMBD3004S	350	410	50	1	1000	1.25	200	0.1	350	5	
1N4148GW6	100	410	4	4	0.001	1	50	2.5	75	1.5	
BAS21GW6	250	250	50	4	0.001	1	100	0.1	200	5	
MMBD3004BRM	350	350	50	1	1000	1.25	200	0.1	240	5	
MCL4150	50	500	4	0.5	1000	1	200	0.1	50	4	
MCL914	100	500	4	0.5	1000	1	10	5	75	4	
BAV301	120	300	75	1	1000	1	100	0.1	100	3	
BAV302	200	300	75	1	1000	1	100	0.1	150	3	
BAV303	250	300	75	1	1000	1	100	0.1	200	3	
LL914	100	500	4	0.5	1000	1	10	5	75	4	
BAV101	120	300	75	1	1000	1	100	0.1	100	3	
BAV102	200	300	75	1	1000	1	100	0.1	150	3	
LS4150	50	500	4	0.5	1000	1	200	0.1	50	4	
LS4448	100	500	4	0.5	1000	1	100	5	75	4	
LS914	100	500	4	0.5	1000	1	10	5	75	4	
BAV201	120	300	75	1	1000	1	100	0.1	100	3	
BAV202	200	300	75	1	1000	1	100	0.1	150	3	
1N4148	100	500	4	0.5	1000	1	10	5	75	4	
1N4150	50	500	4	0.5	1000	1	200	0.1	50	4	
1N914	100	500	4	0.5	1000	1	10	5	75	4	
BAV19	120	500	50	1	1000	1	100	0.1	100	3	
BAV20	200	500	50	1	1000	1	100	0.1	150	3	
BAV21	250	500	50	1	1000	1	100	0.1	200	3	

General Purpose Rectifiers

Part Number	I_F	V_{RRM}	I_{FSM}	$V_F@I_F$	$I_R@V_{RRM}$	Package
	A	V	A	V	μA	
GS1000FL	1	50	30	1.1	1	SOD-123FL
GS1001FL	1	100	30	1.1	1	
GS1002FL	1	200	30	1.1	1	
GS1004FL	1	400	30	1.1	1	
GS1006FL	1	600	30	1.1	1	
GS1008FL	1	800	30	1.1	1	
GS1010FL	1	1000	30	1.1	1	
GS1504FL	1.5	400	50	1.1	1	
GS1506FL	1.5	600	50	1.1	1	
GS1508FL	1.5	800	50	1.1	1	
GS1510FL	1.5	1000	50	1.1	1	
GS1004HE	1	400	30	1.1	1	SOD-123HE
GS1006HE	1	600	30	1.1	1	
GS1008HE	1	800	30	1.1	1	
GS1010HE	1	1000	30	1.1	1	
GS2004HE	2	400	50	1.1	1	
GS2006HE	2	600	50	1.1	1	
GS2008HE	2	800	50	1.1	1	
GS1GAFC	1	400	30	1.1	1	SMAF-C
GS1JAFC	1	600	30	1.1	1	
GS1KAFC	1	800	30	1.1	1	
GS1MAFC	1	1000	30	1.1	1	
GS2GAFC	2	400	70	1.1	1	
GS2JAFC	2	600	70	1.1	1	
GS2KAFC	2	800	70	1.1	1	
GS2MAFC	2	1000	70	1.1	1	
GS1A	1	50	35	1.1	1	SMA
GS1B	1	100	35	1.1	1	
GS1D	1	200	35	1.1	1	
GS1G	1	400	35	1.1	1	
GS1J	1	600	35	1.1	1	
GS1K	1	800	35	1.1	1	
GS1M	1	1000	35	1.1	1	
GT1MMA	1	1000	35	1.1	1	
GS1N	1	1200	35	1.1	1	
GA15Y	1.5	1600	30	1.15	1	
GS1AWG	1	50	30	1.1	1	SMA(W)
GS1B WG	1	100	30	1.1	1	
GS1D WG	1	200	30	1.1	1	
GS1G WG	1	400	30	1.1	1	
GS1J WG	1	600	30	1.1	1	
GS1K WG	1	800	30	1.1	1	
GS1M WG	1	1000	30	1.1	1	
GS1A DWG	1	50	30	1.1	1	
GS1B DWG	1	100	30	1.1	1	
GS1D DWG	1	200	30	1.1	1	
GS1G DWG	1	400	30	1.1	1	
GS1J DWG	1	600	30	1.1	1	
GS1K DWG	1	800	30	1.1	1	
GS1M DWG	1	1000	30	1.1	1	

General Purpose Rectifiers

Part Number	I_F	V_{RRM}	I_{FSM}	$V_F@I_F$	$I_R@V_{RRM}$	Package	
	A	V	A	V	μA		
S1GF	1	400	30	1.1	1	SMBF	
S1JF	1	600	30	1.1	1		
S1KF	1	800	30	1.1	1		
S1MF	1	1000	30	1.1	1		
S2GF	2	400	60	1.1	1		
S2JF	2	600	60	1.1	1		
S2KF	2	800	60	1.1	1		
S2MF	2	1000	60	1.1	1		
S2GGF	2	400	70	1.1	1		
S2JGF	2	600	70	1.1	1		
S2KGF	2	800	70	1.1	1		
S2MGF	2	1000	70	1.1	1		
S1A	1	50	30	1.1	1		SMB
S1B	1	100	30	1.1	1		
S1D	1	200	30	1.1	1		
S1G	1	400	30	1.1	1		
S1J	1	600	30	1.1	1		
S1K	1	800	30	1.1	1		
S1M	1	1000	30	1.1	1		
S2A	2	50	60	1.1	1		
S2B	2	100	60	1.1	1		
S2D	2	200	60	1.1	1		
S2G	2	400	60	1.1	1		
S2J	2	600	60	1.1	1		
S2K	2	800	60	1.1	1		
S2M	2	1000	60	1.1	1		
S3DA	3	200	200	1.1	1		
S3GA	3	400	200	1.1	1		
S3JA	3	600	200	1.1	1		
S3KA	3	800	200	1.1	1		
S3MA	3	1000	200	1.1	1		
S5JB	5	600	200	1.1	1		
S5KB	5	800	200	1.1	1		
S5MB	5	1000	200	1.1	1		
S3A	3	50	200	1.2	1	SMC	
S3B	3	100	200	1.2	1		
S3D	3	200	200	1.2	1		
S3G	3	400	200	1.2	1		
S3J	3	600	200	1.2	1		
S3K	3	800	200	1.2	1		
S3M	3	1000	200	1.2	1		
S5A	5	50	275	1.1	10		
S5B	5	100	275	1.1	10		
S5D	5	200	275	1.1	10		
S5G	5	400	275	1.1	10		
S5J	5	600	275	1.1	10		
S5K	5	800	275	1.1	10		
S5M	5	1000	275	1.1	10		
S8K	8	800	400	0.985	10		
S8M	8	1000	400	0.985	10		
S10KC	10	800	300	1.1	10		
S10MC	10	1000	300	1.1	10		

General Purpose Rectifiers

Part Number	I_F	V_{RRM}	I_{FSM}	$V_F@I_F$	$I_R@V_{RRM}$	Package	
	A	V	A	Max. V	Max. μA		
GV804B	8	400	200	1.1	5	TO-277B	
GV806B	8	600	200	1.1	5		
GV808B	8	800	200	1.1	5		
GV810B	8	1000	200	1.1	5		
GV804	8	400	200	1.1	5	TO-277	
GV806	8	600	200	1.1	5		
GV808	8	800	200	1.1	5		
GV810	8	1000	200	1.1	5		
PGR6016PT	60	1600	800	1.2	5	TO-247AD-2LM	
PGR9016PT	90	1600	915	1.2	5		
PG150	1.5	50	50	1.1	1	DO-15	
PG151	1.5	100	50	1.1	1		
PG152	1.5	200	50	1.1	1		
PG154	1.5	400	50	1.1	1		
PG156	1.5	600	50	1.1	1		
PG158	1.5	800	50	1.1	1		
PG1510	1.5	1000	50	1.1	1		
PG5391	1.5	50	50	1.4	1		
PG5392	1.5	100	50	1.4	1		
PG5393	1.5	200	50	1.4	1		
PG5394	1.5	300	50	1.4	1		
PG5395	1.5	400	50	1.4	1		
PG5396	1.5	500	50	1.4	1		
PG5397	1.5	600	50	1.4	1		
PG5398	1.5	800	50	1.4	1		
PG5399	1.5	1000	50	1.4	1		
PG200	2	50	70	1.1	1		DO-41
PG201	2	100	70	1.1	1		
PG202	2	200	70	1.1	1		
PG204	2	400	70	1.1	1		
PG206	2	600	70	1.1	1		
PG208	2	800	70	1.1	1		
PG2010	2	1000	70	1.1	1		
PG4001	1	50	30	1.1	1		
PG4002	1	100	30	1.1	1		
PG4003	1	200	30	1.1	1		
PG4004	1	400	30	1.1	1		
PG4005	1	600	30	1.1	1		
PG4006	1	800	30	1.1	1		
PG4007	1	1000	30	1.1	1		
PG1517S	1.5	1700	50	2.1	1	DO-201AD	
PG5400	3	50	150	1.2	1		
PG5401	3	100	150	1.2	1		
PG5402	3	200	150	1.2	1		
PG5403	3	300	150	1.2	1		
PG5404	3	400	150	1.2	1		
PG5405	3	500	150	1.2	1		
PG5406	3	600	150	1.2	1		
PG5407	3	800	150	1.2	1		
PG5408	3	1000	150	1.2	1	P-600	
PG600A	6	50	300	1	1		
PG600B	6	100	300	1	1		
PG600D	6	200	300	1	1		
PG600G	6	400	300	1	1		
PG600J	6	600	300	1	1		
PG600K	6	800	300	1	1		
PG600M	6	1000	300	1	1		

Fast Recovery Rectifiers

Part Number	I_F	V_{RRM}	t_{rr}	I_{FSM}	$V_F@I_F$	$I_R@V_{RRM}$	Package	
	A	V	ns	A	V	μA		
RS1001FL	1	100	150	30	1.3	1	SOD-123FL	
RS1002FL	1	200	150	30	1.3	1		
RS1004FL	1	400	150	30	1.3	1		
RS1006FL	1	600	250	30	1.3	1		
RS1008FL	1	800	500	30	1.3	1		
RS1010FL	1	1000	500	30	1.3	1		
FR1AAFC	1	50	150	30	1.3	1	SMAF-C	
FR1BAFC	1	100	150	30	1.3	1		
FR1DAFC	1	200	150	30	1.3	1		
FR1GAFC	1	400	150	30	1.3	1		
FR1JAFC	1	600	250	30	1.3	1		
FR1KAFC	1	800	500	30	1.3	1		
FR1MAFC	1	1000	500	30	1.3	1		
FR2AAFC	2	50	150	50	1.3	1		
FR2BAFC	2	100	150	50	1.3	1		
FR2DAFC	2	200	150	50	1.3	1		
FR2GAFC	2	400	150	50	1.3	1		
FR2JAFC	2	600	250	50	1.3	1		
RS1A	1	50	150	30	1.3	1		SMA
RS1B	1	100	150	30	1.3	1		
RS1D	1	200	150	30	1.3	1		
RS1G	1	400	150	30	1.3	1		
RS1J	1	600	250	30	1.3	1		
RS1K	1	800	500	30	1.3	1		
FR1AF	1	50	150	30	1.3	1	SMBF	
FR1BF	1	100	150	30	1.3	1		
FR1DF	1	200	150	30	1.3	1		
FR1GF	1	400	150	30	1.3	1		
FR1JF	1	600	250	30	1.3	1		
FR2AF	2	50	150	50	1.3	1		
FR2BF	2	100	150	50	1.3	1		
FR2DF	2	200	150	50	1.3	1		
FR2GF	2	400	150	50	1.3	1		
FR2JF	2	600	250	50	1.3	1	SMB	
FR1A	1	50	150	30	1.3	1		
FR1B	1	100	150	30	1.3	1		
FR1D	1	200	150	30	1.3	1		
FR1G	1	400	150	30	1.3	1		
FR1J	1	600	250	30	1.3	1		
FR1K	1	800	500	30	1.3	1		
FR1M	1	1000	500	30	1.3	1		
FR2A	2	50	150	50	1.3	1		
FR2B	2	100	150	50	1.3	1		
FR2D	2	200	150	50	1.3	1		
FR2G	2	400	150	50	1.3	1		
FR2J	2	600	250	50	1.3	1		
FR2K	2	800	500	50	1.3	1		
FR2M	2	1000	500	50	1.3	1		
FR3A	3	50	150	100	1.3	1	SMC	
FR3B	3	100	150	100	1.3	1		
FR3D	3	200	150	100	1.3	1		
FR3G	3	400	150	100	1.3	1		
FR3J	3	600	250	100	1.3	1		
FR3K	3	800	500	100	1.3	1		
FR3M	3	1000	500	100	1.3	1		

Fast Recovery Rectifiers

Part Number	I_F	V_{RRM}	t_{rr}	I_{FSM}	$V_F@I_F$ Max.	$I_R@V_{RRM}$ Max.	Package	
	A	V	ns	A	V	μA		
PG150R	1.5	50	150	50	1.3	1	DO-15	
PG151R	1.5	100	150	50	1.3	1		
PG152R	1.5	200	150	50	1.3	1		
PG154R	1.5	400	150	50	1.3	1		
PG156R	1.5	600	250	50	1.3	1		
PG158R	1.5	800	500	50	1.3	1		
PG1510R	1.5	1000	500	50	1.3	1		
PG200R	2	50	150	70	1.3	1		
PG201R	2	100	150	70	1.3	1		
PG202R	2	200	150	70	1.3	1		
PG204R	2	400	150	70	1.3	1		
PG206R	2	600	250	70	1.3	1		
PG208R	2	800	500	70	1.3	1		
PG2010R	2	1000	500	70	1.3	1		
PG100R	1	50	150	30	1.3	1	DO-41	
PG101R	1	100	150	30	1.3	1		
PG102R	1	200	150	30	1.3	1		
PG104R	1	400	150	30	1.3	1		
PG106R	1	600	250	30	1.3	1		
PG108R	1	800	500	30	1.3	1		
PG1010R	1	1000	500	30	1.3	1		
PG4933	1	50	200	30	1.2	1		
PG4934	1	100	200	30	1.2	1		
PG4935	1	200	200	30	1.2	1		
PG4936	1	400	200	30	1.2	1		
PG4937	1	600	200	30	1.2	1		
PG300R	3	50	150	125	1.3	1		DO-201AD
PG301R	3	100	150	125	1.3	1		
PG302R	3	200	150	125	1.3	1		
PG304R	3	400	150	125	1.3	1		
PG306R	3	600	250	125	1.3	1		
PG308R	3	800	500	125	1.3	1		
PG3010R	3	1000	500	125	1.3	1		
PG600R	6	50	150	250	1.3	1	P-600	
PG601R	6	100	150	250	1.3	1		
PG602R	6	200	150	250	1.3	1		
PG604R	6	400	150	250	1.3	1		
PG606R	6	600	250	250	1.3	1		

Ultra Fast Recovery Rectifiers

Part Number	I_F	V_{RRM}	t_{rr}	I_{FSM}	$V_F@I_F$	$I_R@V_{RRM}$	Package
	A	V	ns	A	V	μA	
US1001FL	1	100	50	30	1	1	SOD-123FL
US1002FL	1	200	50	30	1	1	
US1004FL	1	400	50	30	1.4	1	
US1006FL	1	600	100	30	1.7	1	
US1008FL	1	800	100	30	1.7	1	
US1AAFC	1	50	50	30	1	1	SMAF-C
US1BAFC	1	100	50	30	1	1	
US1DAFC	1	200	50	30	1	1	
US1GAFC	1	400	50	30	1.4	1	
US1JAFC	1	600	100	30	1.7	1	
US1KAFC	1	800	100	30	1.7	1	
US1MAFC	1	1000	100	30	1.7	1	SMA
US1A	1	50	50	30	1	1	
US1B	1	100	50	30	1	1	
US1D	1	200	50	30	1	1	
US1G	1	400	50	30	1.3	1	
US1J	1	600	100	30	1.7	1	
US1K	1	800	100	30	1.7	1	
US1M	1	1000	100	30	1.7	1	
US1R	1	1300	75	30	1.9	1	
UFA15M	1.5	1000	100	50	1.7	1	
UF1AF	1	50	50	30	1	1	SMBF
UF1BF	1	100	50	30	1	1	
UF1DF	1	200	50	30	1	1	
UF1GF	1	400	50	30	1.4	1	
UF1JF	1	600	100	30	1.7	1	
UF2AF	2	50	50	50	1	1	
UF2BF	2	100	50	50	1	1	
UF2DF	2	200	50	50	1	1	
UF2GF	2	400	50	50	1.4	1	
UF2JF	2	600	100	50	1.7	1	
UF1A	1	50	50	30	1	1	SMB
UF1B	1	100	50	30	1	1	
UF1D	1	200	50	30	1	1	
UF1G	1	400	50	30	1.3	1	
UF1J	1	600	100	30	1.7	1	
UF1K	1	800	100	30	1.7	1	
UF1M	1	1000	100	30	1.7	1	
UF2A	2	50	50	50	1	1	
UF2B	2	100	50	50	1	1	
UF2D	2	200	50	50	1	1	
UF2G	2	400	50	50	1.3	1	
UF2J	2	600	100	50	1.7	1	
UF2K	2	800	100	50	1.7	1	
UF2M	2	1000	100	50	1.7	1	
UF3A	3	50	50	100	1	1	
UF3B	3	100	50	100	1	1	
UF3D	3	200	50	100	1	1	
UF3G	3	400	50	100	1.3	1	
UF3J	3	600	100	100	1.7	1	
UF3K	3	800	100	100	1.7	1	
UF3M	3	1000	100	100	1.7	1	

Ultra Fast Recovery Rectifiers

Part Number	I_F	V_{RRM}	t_{rr}	I_{FSM}	$V_F@I_F$	$I_R@V_{RRM}$	Package
	A	V	ns	A	Max. V	Max. μA	
UF1000CT	2 x 5	50	50	125	1	1	TO-220AB
UF1001CT	2 x 5	100	50	125	1	1	
UF1002CT	2 x 5	200	50	125	1	1	
UF1003CT	2 x 5	300	50	125	1.3	1	
UF1004CT	2 x 5	400	50	125	1.3	1	
UF1006CT	2 x 5	600	100	125	1.7	1	
UF1600CT	2 x 8	50	50	125	1	1	
UF1601CT	2 x 8	100	50	125	1	1	
UF1602CT	2 x 8	200	50	125	1	1	
UF1603CT	2 x 8	300	50	125	1.3	1	
UF1604CT	2 x 8	400	50	125	1.3	1	
UF1606CT	2 x 8	600	100	125	1.7	1	
UF1608CT	2 x 8	800	100	125	1.7	1	
UF2000CT	2 x 10	50	50	150	1	1	
UF2001CT	2 x 10	100	50	150	1	1	
UF2002CT	2 x 10	200	50	150	1	1	
UF2003CT	2 x 10	300	50	150	1.3	1	
UF2004CT	2 x 10	400	50	150	1.3	1	
UF2006CT	2 x 10	600	100	150	1.7	1	
UF800	8	50	50	125	1	1	
UF801	8	100	50	125	1	1	
UF802	8	200	50	125	1	1	
UF803	8	300	50	125	1.3	1	
UF804	8	400	50	125	1.3	1	
UF806	8	600	100	125	1.7	1	
UF808	8	800	100	125	1.7	1	
UF1000	10	50	50	150	1	1	
UF1001	10	100	50	150	1	1	
UF1002	10	200	50	150	1	1	
UF1003	10	300	50	150	1.3	1	
UF1004	10	400	50	150	1.3	1	
UF1006	10	600	100	150	1.7	1	
UF1008	10	800	100	150	1.7	1	
UF1000FCT	2 x 5	50	50	125	1	1	ITO-220AB
UF1001FCT	2 x 5	100	50	125	1	1	
UF1002FCT	2 x 5	200	50	125	1	1	
UF1003FCT	2 x 5	300	50	125	1.3	1	
UF1004FCT	2 x 5	400	50	125	1.3	1	
UF1006FCT	2 x 5	600	100	125	1.7	1	
UF1600FCT	2 x 8	50	50	125	1	1	
UF1601FCT	2 x 8	100	50	125	1	1	
UF1602FCT	2 x 8	200	50	125	1	1	
UF1603FCT	2 x 8	300	50	125	1.3	1	
UF1604FCT	2 x 8	400	50	125	1.3	1	
UF1606FCT	2 x 8	600	100	125	1.7	1	
UF2002FCT	2 x 10	200	50	150	1	1	
UF2003FCT	2 x 10	300	50	150	1.3	1	
UF2004FCT	2 x 10	400	50	150	1.3	1	
UF2006FCT	2 x 10	600	100	150	1.7	1	
UF800F	8	50	50	125	1	1	ITO-220AC
UF801F	8	100	50	125	1	1	
UF802F	8	200	50	125	1	1	
UF803F	8	300	50	125	1.3	1	
UF804F	8	400	50	125	1.3	1	
UF806F	8	600	100	125	1.7	1	
UF808F	8	800	100	125	1.7	1	

Ultra Fast Recovery Rectifiers

Part Number	I_F	V_{RRM}	t_{rr}	I_{FSM}	$V_F@I_F$ Max.	$I_R@V_{RRM}$ Max.	Package
	A	V	ns	A	V	μA	
UF1000F	10	50	50	150	1	1	ITO-220AC
UF1001F	10	100	50	150	1	1	
UF1002F	10	200	50	150	1	1	
UF1003F	10	300	50	150	1.3	1	
UF1004F	10	400	50	150	1.3	1	
UF1006F	10	600	100	150	1.7	1	
UF1008F	10	800	100	150	1.7	1	
UF150G	1.5	50	50	50	1	1	
UF151G	1.5	100	50	50	1	1	
UF152G	1.5	200	50	50	1	1	
UF154G	1.5	400	50	50	1.3	1	
UF156G	1.5	600	100	50	1.7	1	
UF158G	1.5	800	100	50	1.7	1	
UF1510G	1.5	1000	100	50	1.7	1	
UF200G	2	50	50	60	1	1	
UF201G	2	100	50	60	1	1	
UF202G	2	200	50	60	1	1	
UF204G	2	400	50	60	1.3	1	
UF206G	2	600	100	60	1.7	1	
UF208G	2	800	100	60	1.7	1	
UF2010G	2	1000	100	60	1.7	1	
UF100G	1	50	50	30	1	1	DO-41
UF101G	1	100	50	30	1	1	
UF102G	1	200	50	30	1	1	
UF104G	1	400	50	30	1.3	1	
UF106G	1	600	100	30	1.7	1	
UF108G	1	800	100	30	1.7	1	
UF1010G	1	1000	100	30	1.7	1	
UF300G	3	50	50	150	1	1	DO-201AD
UF301G	3	100	50	150	1	1	
UF302G	3	200	50	150	1	1	
UF304G	3	400	50	150	1.3	1	
UF306G	3	600	100	150	1.7	1	
UF308G	3	800	100	150	1.7	1	
UF3010G	3	1000	100	150	1.7	1	
UF408G	4	800	75	150	1.85	10	
UF4010G	4	1000	75	150	1.85	10	
UF504IG	5	400	50	80	1.25	1	

Super Fast Recovery Rectifiers

Part Number	I_F	V_{RRM}	t_{rr}	I_{FSM}	$V_F@I_F$ Max.	$I_R@V_{RRM}$ Max.	Package
	A	V	ns	A	V	μA	
ES1001FL	1	100	35	30	0.95	1	SOD-123FL
ES1002FL	1	200	35	30	0.95	1	
ES1004FL	1	400	35	30	1.25	1	
ES1006FL	1	600	35	30	1.7	1	
ERT1AAFC	1	50	25	30	0.95	1	SMAF-C
ERT1BAFC	1	100	25	30	0.95	1	
ERT1CAFC	1	150	25	30	0.95	1	
ERT1DAFC	1	200	25	30	0.95	1	
ERT1EAFC	1	300	25	30	1.25	1	
ERT1GAFC	1	400	25	30	1.25	1	
ER1AAFC	1	50	35	30	0.95	1	
ER1BAFC	1	100	35	30	0.95	1	
ER1CAFC	1	150	35	30	0.95	1	
ER1DAFC	1	200	35	30	0.95	1	
ER1EAFC	1	300	35	30	1.25	1	
ER1GAFC	1	400	35	30	1.25	1	
ER1JAFC	1	600	35	30	1.7	1	
ERT2AAFC	2	50	25	50	0.95	1	
ERT2BAFC	2	100	25	50	0.95	1	
ERT2CAFC	2	150	25	50	0.95	1	
ERT2DAFC	2	200	25	50	0.95	1	
ERT2EAFC	2	300	25	50	1.25	1	
ERT2GAFC	2	400	25	50	1.25	1	
ES1A	1	50	35	30	0.95	1	
ES1B	1	100	35	30	0.95	1	
ES1C	1	150	35	30	0.95	1	
ES1D	1	200	35	30	0.95	1	
ES1E	1	300	35	30	1.25	1	
ES1G	1	400	35	30	1.25	1	
ES1J	1	600	35	30	1.7	1	
MURA1J	1	600	50	30	1.25	5	
ES2A	2	50	35	50	0.95	1	
ES2B	2	100	35	50	0.95	1	
ES2C	2	150	35	50	0.95	1	
ES2D	2	200	35	50	0.95	1	
ES2E	2	300	35	50	1.25	1	
ES2G	2	400	35	50	1.25	1	
ES2J	2	600	35	50	1.7	1	
MURA2J	2	600	50	30	1.35	5	
ES1AWG	1	50	35	30	0.95	1	SMA(W)
ES1BWG	1	100	35	30	0.95	1	
ES1CWG	1	150	35	30	0.95	1	
ES1DWG	1	200	35	30	0.95	1	
ES1EWG	1	300	35	30	1.25	1	
ES1GWG	1	400	35	30	1.25	1	
ES1JWG	1	600	35	30	1.7	1	

Super Fast Recovery Rectifiers

Part Number	I_F	V_{RRM}	t_{rr}	I_{FSM}	$V_F@I_F$ Max.	$I_R@V_{RRM}$ Max.	Package	
	A	V	ns	A	V	μA		
ER1AF	1	50	35	30	0.95	1	SMBF	
ER1BF	1	100	35	30	0.95	1		
ER1CF	1	150	35	30	0.95	1		
ER1DF	1	200	35	30	0.95	1		
ER1EF	1	300	35	30	1.25	1		
ER1GF	1	400	35	30	1.25	1		
ER1JF	1	600	35	30	1.7	1		
ERT2AF	2	50	25	50	0.95	1		
ERT2BF	2	100	25	50	0.95	1		
ERT2CF	2	150	25	50	0.95	1		
ERT2DF	2	200	25	50	0.95	1		
ERT2EF	2	300	25	50	1.25	1		
ERT2GF	2	400	25	50	1.25	1		
ERT2JF	2	600	25	50	1.7	1		
ER2AF	2	50	35	50	0.95	1		
ER2BF	2	100	35	50	0.95	1		
ER2CF	2	150	35	50	0.95	1		
ER2DF	2	200	35	50	0.95	1		
ER2EF	2	300	35	50	1.25	1		
ER2GF	2	400	35	50	1.25	1		
ER2JF	2	600	35	50	1.7	1		
ERT3AAF	3	50	25	75	0.95	1		
ERT3BAF	3	100	25	75	0.95	1		
ERT3CAF	3	150	25	75	0.95	1		
ERT3DAF	3	200	25	75	0.95	1		
ERT3EAF	3	300	25	75	1.25	1		
ERT3GAF	3	400	25	75	1.25	1		
ER3EAF	3	300	35	80	1.25	1		
ER3GAF	3	400	35	80	1.25	1		
ER1A	1	50	35	30	0.95	1		SMB
ER1B	1	100	35	30	0.95	1		
ER1C	1	150	35	30	0.95	1		
ER1D	1	200	35	30	0.95	1		
ER1E	1	300	35	30	1.25	1		
ER1G	1	400	35	30	1.25	1		
ER1J	1	600	35	30	1.7	1		
MURB1J	1	600	50	30	1.25	5		
ER2A	2	50	35	50	0.95	1		
ER2B	2	100	35	50	0.95	1		
ER2C	2	150	35	50	0.95	1		
ER2D	2	200	35	50	0.95	1		
ER2E	2	300	35	50	1.25	1		
ER2G	2	400	35	50	1.25	1		
ER2J	2	600	35	50	1.7	1		
MURB2J	2	600	50	30	1.35	5		
ER3AA	3	50	35	80	0.95	1		
ER3BA	3	100	35	80	0.95	1		
ER3CA	3	150	35	80	0.95	1		
ER3DA	3	200	35	80	0.95	1		
ER3EA	3	300	35	80	1.25	1		
ER3GA	3	400	35	80	1.25	1		
ER3JA	3	600	35	80	1.7	1		
MURB3J	3	600	50	80	1.25	5		
MURB3JG	3	600	50	100	1.25	5		

Super Fast Recovery Rectifiers

Part Number	I_F	V_{RRM}	t_{rr}	I_{FSM}	$V_F@I_F$ Max.	$I_R@V_{RRM}$ Max.	Package
	A	V	ns	A	V	μA	
ER3A	3	50	35	100	0.95	1	SMC
ER3B	3	100	35	100	0.95	1	
ER3C	3	150	35	100	0.95	1	
ER3D	3	200	35	100	0.95	1	
ER3E	3	300	35	100	1.25	1	
ER3G	3	400	35	100	1.25	1	
ER3J	3	600	35	100	1.7	1	
MURC3J	3	600	50	80	1.25	5	
MURC4JI	4	600	50	80	1.28	5	
MURC4J	4	600	50	110	1.28	5	
MURC5J	5	600	50	110	1.3	5	
ED302D	3	200	35	75	0.95	1	TO-252AA
ED303D	3	300	35	75	1.3	1	
ED304D	3	400	35	75	1.3	1	
ED306D	3	600	35	75	1.7	1	
ED502D	5	200	35	75	0.95	1	
ED503D	5	300	35	75	1.25	1	
ED504D	5	400	35	75	1.25	1	
ED506D	5	600	35	75	1.7	1	
ED602CD	2 x 3	200	35	75	0.95	1	
ED603CD	2 x 3	300	35	75	1.3	1	
ED604CD	2 x 3	400	35	75	1.3	1	
ED606CD	2 x 3	600	35	75	1.7	1	
ED802CD	2 x 4	200	35	70	0.95	5	
ED803CD	2 x 4	300	50	70	1.3	5	
ED804CD	2 x 4	400	50	70	1.3	5	
ED806CD	2 x 4	600	50	70	1.7	5	
ED1002CD	2 x 5	200	35	100	0.95	5	
ED1003CD	2 x 5	300	50	100	1.3	5	
ED1004CD	2 x 5	400	50	100	1.3	5	
ED1006CD	2 x 5	600	50	100	1.7	5	
ER1604DY	2 x 8	400	35	300	1.3	1	
ER1000CT	2 x 5	50	35	150	0.95	1	TO-220AB
ER1001CT	2 x 5	100	35	150	0.95	1	
ER1001ACT	2 x 5	150	35	150	0.95	1	
ER1002CT	2 x 5	200	35	150	0.95	1	
ER1003CT	2 x 5	300	35	150	1.3	1	
ER1004CT	2 x 5	400	35	150	1.3	1	
ER1006CT	2 x 5	600	35	150	1.7	1	
ER1600CT	2 x 8	50	35	125	0.95	1	
ER1601CT	2 x 8	100	35	125	0.95	1	
ER1601ACT	2 x 8	150	35	125	0.95	1	
ER1602CT	2 x 8	200	35	125	0.95	1	
ER1603CT	2 x 8	300	35	125	1.3	1	
ER1604CT	2 x 8	400	35	125	1.3	1	
ER1606CT	2 x 8	600	35	125	1.7	1	
ER2000CT	2 x 10	50	35	150	0.95	1	
ER2001CT	2 x 10	100	35	150	0.95	1	
ER2001ACT	2 x 10	150	35	150	0.95	1	
ER2002CT	2 x 10	200	35	150	0.95	1	
ER2003CT	2 x 10	300	50	150	1.3	1	
ER2004CT	2 x 10	400	50	150	1.3	1	
ER2006CT	2 x 10	600	50	150	1.7	1	

Super Fast Recovery Rectifiers

Part Number	I_F	V_{RRM}	trr	I_{FSM}	$V_F@I_F$ Max.	$I_R@V_{RRM}$ Max.	Package
	A	V	ns	A	V	μA	
ER800	8	50	35	125	0.95	1	TO-220AC
ER801	8	100	35	125	0.95	1	
ER801A	8	150	35	125	0.95	1	
ER802	8	200	35	125	0.95	1	
ER803	8	300	35	125	1.3	1	
ER804	8	400	35	125	1.3	1	
ER806	8	600	35	125	1.7	1	
ER1000	10	50	35	150	0.95	1	
ER1001	10	100	35	150	0.95	1	
ER1001A	10	150	35	150	0.95	1	
ER1002	10	200	35	150	0.95	1	
ER1003	10	300	50	150	1.3	1	
ER1004	10	400	50	150	1.3	1	
ER1006	10	600	50	150	1.7	1	
ER1000FCT	2 x 5	50	35	150	0.95	1	
ER1001FCT	2 x 5	100	35	150	0.95	1	
ER1001AFCT	2 x 5	150	35	150	0.95	1	
ER1002FCT	2 x 5	200	35	150	0.95	1	
ER1003FCT	2 x 5	300	35	150	1.3	1	
ER1004FCT	2 x 5	400	35	150	1.3	1	
ER1006FCT	2 x 5	600	35	150	1.7	1	
ER1600FCT	2 x 8	50	35	125	0.95	1	
ER1601FCT	2 x 8	100	35	125	0.95	1	
ER1601AFCT	2 x 8	150	35	125	0.95	1	
ER1602FCT	2 x 8	200	35	125	0.95	1	
ER1603FCT	2 x 8	300	35	125	1.3	1	
ER1604FCT	2 x 8	400	35	125	1.3	1	
ER1606FCT	2 x 8	600	35	125	1.7	1	
ER2000FCT	2 x 10	50	35	150	0.95	1	
ER2001FCT	2 x 10	100	35	150	0.95	1	
ER2001AFCT	2 x 10	150	35	150	0.95	1	
ER2002FCT	2 x 10	200	35	150	0.95	1	
ER2003FCT	2 x 10	300	50	150	1.3	1	
ER2004FCT	2 x 10	400	50	150	1.3	1	
ER2006FCT	2 x 10	600	50	150	1.7	1	
ER1000F	10	50	35	150	0.95	1	ITO-220AC
ER1001F	10	100	35	150	0.95	1	
ER1001AF	10	150	35	150	0.95	1	
ER1002F	10	200	35	150	0.95	1	
ER1003F	10	300	50	150	1.3	1	
ER1004F	10	400	50	150	1.3	1	
ER1006F	10	600	50	150	1.7	1	
ER800F	8	50	35	125	0.95	1	
ER801F	8	100	35	125	0.95	1	
ER801AF	8	150	35	125	0.95	1	
ER802F	8	200	35	125	0.95	1	
ER803F	8	300	35	125	1.3	1	
ER804F	8	400	35	125	1.3	1	

Super Fast Recovery Rectifiers

Part Number	I_F	V_{RRM}	trr	I_{FSM}	$V_F@I_F$ Max.	$I_R@V_{RRM}$ Max.	Package
	A	V	ns	A	V	μA	
ER3002PT	2 x 15	200	35	300	0.95	1	TO-3P/TO-247AD
ER3004PT	2 x 15	400	35	300	1.3	1	
ER200	2	50	35	50	0.95	1	DO-15
ER201	2	100	35	50	0.95	1	
ER201A	2	150	35	50	0.95	1	
ER202	2	200	35	50	0.95	1	
ER203	2	300	35	50	1.25	1	
ER204	2	400	35	50	1.25	1	
ER206	2	600	35	50	1.7	1	
ER100	1	50	35	30	0.95	1	
ER101	1	100	35	30	0.95	1	
ER101A	1	150	35	30	0.95	1	
ER102	1	200	35	30	0.95	1	
ER103	1	300	35	30	1.25	1	
ER104	1	400	35	30	1.25	1	
ER106	1	600	35	30	1.7	1	
ER108	1	800	35	30	2.5	1	
MUR160K	1	600	50	30	1.25	5	
MUR260K	2	600	50	30	1.35	5	
ER300	3	50	35	125	0.95	1	DO-201AD
ER301	3	100	35	125	0.95	1	
ER301A	3	150	35	125	0.95	1	
ER302	3	200	35	125	0.95	1	
ER303	3	300	35	125	1.25	1	
ER304	3	400	35	125	1.25	1	
ER306	3	600	35	125	1.7	1	
ER306A	3	700	35	125	2	1	
ER308	3	800	35	125	2.5	1	
MUR360M	3	600	50	80	1.25	5	
MUR460IM	4	600	50	80	1.28	5	
MUR460M	4	600	50	110	1.28	5	
ER500	5	50	35	150	0.95	1	
ER501	5	100	35	150	0.95	1	
ER501A	5	150	35	150	0.95	1	
ER502	5	200	35	150	0.95	1	
ER503	5	300	35	150	1.25	1	
ER504	5	400	35	150	1.25	1	
ER506	5	600	35	150	1.7	1	
MUR560M	5	600	50	110	1.3	5	

Hyper Fast Recovery Rectifiers

Part Number	I_F	V_{RRM}	t_{rr}	I_{FSM}	$V_F@I_F$ Max.	$I_R@V_{RRM}$ Max.	Package
	A	V	ns	A	V	μA	
MER2DAH	2	200	35	60	0.95	1	SOD-123HE
MER3DAH	3	200	35	75	0.95	1	
MSR1DAL	1	200	20	40	0.95	1	
MER2DAL	2	200	35	60	0.95	1	SOD-123FL
MSR2DAL	2	200	20	50	0.95	1	
MER2DAFC	2	200	35	60	0.95	1	
MSR2DAFC	2	200	20	60	0.95	1	SMAF-C
MER3DAFC	3	200	35	75	0.95	1	
MER1DMA	1	200	35	35	0.95	1	
MER2DMA	2	200	35	60	0.95	1	SMA
MER3DMA	3	200	35	75	0.95	1	
MER2DBF	2	200	35	60	0.95	1	
MER3DBF	3	200	35	75	0.95	1	SMBF
MER1DMB	1	200	35	35	0.95	1	SMB
MER2DMB	2	200	35	60	0.95	1	
MER3DMB	3	200	35	75	0.95	1	
MER1002CT	10	200	25	100	0.95	1	TO-220AB
MER1602CT	16	200	35	120	0.95	1	
MER2002CT	20	200	35	170	0.95	1	
MER502T	5	200	25	100	0.95	1	TO-220AC
MER802T	8	200	35	120	0.95	1	
MER1002T	10	200	35	170	0.95	1	
MER1002FCT	10	200	35	100	0.95	1	ITO-220AB
MER1602FCT	16	200	35	120	0.95	1	
MER2002FCT	20	200	35	170	0.95	1	
MER502FT	5	200	35	100	0.95	1	ITO-220AC
MER802FT	8	200	35	120	0.95	1	
MER1002FT	10	200	35	170	0.95	1	

FRED

Part Number	I_F	V_{RRM}	trr^*	I_{FSM}	$V_F@I_F$ Typ.	$I_R@V_{RRM}$ Max.	Package
	A	V	ns	A	V	μA	
PSDD0860S1	8	600	35	75	1.8	100	TO-252AA
PSDD0860L1	8	600	60	85	1.3	100	
PSDC0860S1	8	600	35	75	1.8	100	
PSDC0860L1	8	600	40	85	1.3	100	
PSDB0860S1	8	600	35	75	1.8	100	TO-263
PSDB0860L1	8	600	60	85	1.3	100	
PSDB1560S1	15	600	42	140	1.8	100	
PSDB1560L1	15	600	70	180	1.3	100	
PSDB3060S1	30	600	45	175	1.8	250	
PSDB3060L1	30	600	75	230	1.3	250	
PSDP0860S1	8	600	35	85	1.8	100	TO-220AC
PSDP0860L1	8	600	60	95	1.3	100	
PSDP1560S1	15	600	42	140	1.8	100	
PSDP1560L1	15	600	70	180	1.3	100	
PSDP3060S1	30	600	45	175	1.8	250	
PSDP3060L1	30	600	75	230	1.3	250	
PSDF0860S1	8	600	35	75	1.8	100	ITO-220AC
PSDF0860L1	8	600	60	85	1.3	100	
PSDF1560S1	15	600	42	140	1.8	100	
PSDF1560L1	15	600	70	180	1.3	100	
PSDF3060S1	30	600	45	175	1.8	250	
PSDF3060L1	30	600	75	230	1.3	250	
PSDH3060S1	30	600	45	250	1.8	250	TO-247AD-2LD
PSDH3060L1	30	600	75	270	1.3	250	
PSDH6060S1	60	600	55	400	1.65	250	
PSDH6060L1	60	600	135	430	1.25	250	
PSDH3060CCS1	30	600	42	140	1.8	100	TO-247AD-3LD
PSDH3060CCL1	30	600	70	180	1.3	100	
PSDH6060CCS1	60	600	45	175	1.8	250	
PSDH6060CCL1	60	600	75	230	1.3	250	

*Ditt testing condition follow datasheet specification

Bridge Rectifiers

Part Number	I_F	V_{RRM}	I_{FSM}	$V_F@I_F$	$I_R@V_{RRM}$	Package	
	A	V	A	V	μA		
DXK210	2	1000	75	1.05	5	DXK	
DXK310	3	1000	90	1.05	5		
DXK410	4	1000	135	1.05	5		
DXK610	6	1000	150	1.05	5		
DXK810	8	1000	170	1.05	5		
KBP2MI	2	1000	75	1.1	5	KBP	
GBL410	4	1000	150	1.05	5	GBL-2	
GBL610	6	1000	160	1.05	5		
GBL810	8	1000	200	1.05	5		
GBU410	4	1000	160	1.05	5	GBU-2	
GBU610	6	1000	175	1.05	5		
GBU810	8	1000	220	1.05	5		
GBU1008LV	10	800	240	0.94	5		
GBU1010	10	1000	240	1.05	5		
GBU1506ULV	15	600	220	0.92	1		
GBU1506LV	15	600	240	0.98	5		
GBU1508LL	15	800	240	0.95	5		
GBU1508LV	15	800	240	0.98	5		
GBU15KULV*	15	800	250	0.92	1		
GBU1510	15	1000	200	1.05	5		
GBU2008LV	20	800	400	0.92	5		
GBU2506ULV	25	600	350	0.92	1		
GBU2506HULV	25	600	380	0.92	1		
GBU2506LV	25	600	400	0.98	5		
GBU2508LV	25	800	400	0.95	5		
GBU2508LL	25	800	400	0.95	5		
GBU25KULV*	25	800	400	0.92	1		
GBU2510	25	1000	350	1.05	5		
GBU2510H	25	1000	350	1.05	5		
GBU3008	30	800	350	1.05	5		
GBU3510	35	1000	400	1.1	5		
GBU3510H	35	1000	400	1.1	5		
KBJ410	4	1000	135	1.05	5		KBJ-2
KBJ610	6	1000	170	1.05	5		
KBJ1010	10	1000	170	1.05	5		
KBJ1510	15	1000	180	1.05	5		
KBJ2010	20	1000	200	1.05	5		
KBJ2510	25	1000	240	1.05	5		
KBJ3510	35	1000	350	1.05	5		

*Under Development

Bridge Rectifiers

Part Number	I_F	V_{RRM}	I_{FSM}	$V_F@I_F$	$I_R@V_{RRM}$	Package
	A	V	A	Max. V	Max. μA	
GBJ1010	10	1000	220	1.05	5	GBJ-2
GBJ1506ULV	15	600	220	0.92	1	
GBJ15KULV*	15	800	250	0.92	1	
GBJ1510	15	1000	240	1.05	5	
GBJ2010	20	1000	260	1.05	5	
GBJ2506ULV	25	600	350	0.92	1	
GBJ25KULV*	25	800	400	0.92	1	
GBJ2508LV	25	800	500	0.94	5	
GBJ2510H	25	1000	350	1.05	5	
GBJ2510	25	1000	350	1.05	5	
GBJ3506ULV	35	600	400	0.92	1	
GBJ3510	35	1000	400	1.1	5	
GBJ3510H	35	1000	400	1.1	5	
GBJ5010	50	1000	500	1.1	5	
GBJA1506*	15	600	240	1	5	
GBJA1508*	15	800	240	1	5	
GBJA1510*	15	1000	240	1	5	
GBJA2506*	25	600	300	1	5	
GBJA2508*	25	800	300	1	5	
GBJA2510*	25	1000	300	1	5	
GBJA3506*	35	600	360	1	5	
GBJA3508*	35	800	360	1	5	
GBJA3510*	35	1000	360	1	5	
KBJB1006*	10	600	175	1	5	KBJB
KBJB1008*	10	800	175	1	5	
KBJB1010*	10	1000	175	1	5	
KBJB1506*	15	600	220	1	5	
KBJB1508*	15	800	220	1	5	
KBJB1510*	15	1000	200	1	5	
PMS210	2	1000	70	1.05	5	M4
PMS308LL	3	800	110	0.95	5	
PMS310	3	1000	110	1.05	5	
PMS408LL	4	800	120	0.95	5	
PMS410	4	1000	120	1.05	5	
PM510	5	1000	130	1.05	5	M8
PM808LL*	8	800	170	0.95	5	
PM8KULV*	8	800	200	0.92	1	
PM810	8	1000	170	1.05	5	
PM1008LL*	10	800	190	0.95	5	
PM1010	10	1000	190	1.05	5	

*Under Development

Bridge Rectifiers

Part Number	I_F	V_{RRM}	I_{FSM}	$V_F@I_F$	$I_R@V_{RRM}$	Package
	A	V	A	Max. V	Max. μA	
R8S	0.5	800	30	1.15	5	MDI
B1S	0.8	100	35	1	5	
B2S	0.8	200	35	1	5	
B4S	0.8	400	35	1	5	
B6S	0.8	600	35	1	5	
B8S	0.8	800	35	1	5	
B10S	0.8	1000	35	1	5	
B1005S	1	50	30	1.1	5	
B101S	1	100	30	1.1	5	
B102S	1	200	30	1.1	5	
B104S	1	400	30	1.1	5	
B106S	1	600	30	1.1	5	
B108S	1	800	30	1.1	5	
B1010S	1	1000	30	1.1	5	
ABS1M	1	1000	35	1.1	5	
ABS2M	2	1000	60	1	5	
ABS2MS	2	1000	70	1.1	5	
MSB2M	2	1000	70	1.1	5	MSBL
MSB3M	3	1000	110	1.1	5	
MSB4M	4	1000	120	1.1	5	
DI100	1	50	30	1.1	5	DIP
DI101	1	100	30	1.1	5	
DI102	1	200	30	1.1	5	
DI104	1	400	30	1.1	5	
DI106	1	600	30	1.1	5	
DI108	1	800	30	1.1	5	
DI1010	1	1000	30	1.1	5	
DI150	1.5	50	50	1.1	5	
DI151	1.5	100	50	1.1	5	
DI152	1.5	200	50	1.1	5	
DI154	1.5	400	50	1.1	5	
DI156	1.5	600	50	1.1	5	
DI158	1.5	800	50	1.1	5	
DI1510	1.5	1000	50	1.1	5	
DI100S	1	50	30	1.1	5	
DI101S	1	100	30	1.1	5	
DI102S	1	200	30	1.1	5	
DI104S	1	400	30	1.1	5	
DI106S	1	600	30	1.1	5	
DI108S	1	800	30	1.1	5	
DI1010S	1	1000	30	1.1	5	
DI150S	1.5	50	50	1.1	5	
DI151S	1.5	100	50	1.1	5	
DI152S	1.5	200	50	1.1	5	
DI154S	1.5	400	50	1.1	5	
DI156S	1.5	600	50	1.1	5	
DI158S	1.5	800	50	1.1	5	
DI1510S	1.5	1000	50	1.1	5	
DI200S	2	50	50	1.1	5	
DI201S	2	100	50	1.1	5	
DI202S	2	200	50	1.1	5	
DI204S	2	400	50	1.1	5	
DI206S	2	600	50	1.1	5	
DI208S	2	800	50	1.1	5	
DI2010S	2	1000	50	1.1	5	

*Under Development

Schottky Bridge Rectifiers

Part Number	I_F	V_{RRM}	I_{FSM}	$V_F@I_F$ Max.		$I_R@V_R$ Max.		Package
	A	V	A	V	A	μA	V	
TS140S	1	40	30	0.5	1	100	40	MICRO DIP
TS240S	2	40	50	0.5	2	50	40	
TSM340IS	3	40	60	0.56	3	140	40	
TS340IS	3	40	60	0.53	3	100	40	
TS260S	2	60	50	0.7	2	50	60	
TS360ILS	3	60	60	0.66	3	65	60	
TS1100S	1	100	30	0.75	1	10	100	
TS2100S	2	100	50	0.84	2	4	100	

Fast Bridges Rectifiers

Part Number	I_F	V_{RRM}	I_{FSM}	$V_F@I_F$ Max.	$I_R@V_{RRM}$ Max.	Package
	A	V	A	V	μA	
RDXK210	2	1000	100	1.3	5	DXK
RDXK410	4	1000	120	1.3	5	
RDXK610	6	1000	130	1.3	5	
RDXK810	8	1000	150	1.3	5	
RPMS210	2	1000	100	1.3	5	M4
RPMS310	3	1000	110	1.3	5	
RPMS410	4	1000	120	1.3	5	
RPMS510	5	1000	130	1.3	5	
RPM610	6	1000	150	1.3	5	M8
RPM810	8	1000	160	1.3	5	
RABS2M	2	1000	50	1.3	5	ABS
RMSB3M	3	1000	90	1.3	5	MSBL
RMSB4M	4	1000	95	1.3	5	

Zener Diodes

Part Number	P _D	V _Z	V _Z @ I _{ZT} (V)			Z _{VT} @ I _{ZT} Max.	I _{ZT}	Z _{ZK} @ I _{ZK} Max.	I _{ZK}	I _R @ V _R Max.		Package
	mW	%	Nom.	Min.	Max.	Ω	mA	Ω	mA	μA	V	
PZS52C3V9M1Q	250	5	3.9	3.705	4.095	90	5	500	1	3	1	DFN1006-2L
PZS52C4V3M1Q	250	5	4.3	4.085	4.515	90	5	600	1	3	1	
PZS52C4V7M1Q	250	5	4.7	4.465	4.935	80	5	500	1	3	2	
PZS52C5V1M1Q	250	5	5.1	4.845	5.355	60	5	480	1	2	2	
PZS52C5V6M1Q	250	5	5.6	5.32	5.88	40	5	400	1	1	2	
PZS52C6V2M1Q	250	5	6.2	5.89	6.51	10	5	150	1	3	4	
PZS52C6V8M1Q	250	5	6.8	6.46	7.14	15	5	80	1	2	4	
PZS52C7V5M1Q	250	5	7.5	7.125	7.875	15	5	80	1	1	5	
PZS52C8V2M1Q	250	5	8.2	7.79	8.61	15	5	80	1	0.7	5	
PZS52C9V1M1Q	250	5	9.1	8.645	9.555	15	5	100	1	0.5	6	
PZS52C10M1Q	250	5	10	9.5	10.5	20	5	150	1	0.2	7	
PZS52C11M1Q	250	5	11	10.45	11.55	20	5	150	1	0.1	8	
PZS52C12M1Q	250	5	12	11.4	12.6	25	5	150	1	0.1	8	
PZS52C13M1Q	250	5	13	12.35	13.65	30	5	170	1	0.1	8	
PZS52C15M1Q	250	5	15	14.25	15.75	30	5	200	1	0.05	10.5	
PZS52C16M1Q	250	5	16	15.2	16.8	40	5	200	1	0.05	11.2	
PZS52C18M1Q	250	5	18	17.1	18.9	45	5	225	1	0.05	12.6	
PZS52C20M1Q	250	5	20	19	21	55	5	225	1	0.05	14	
PZS52C22M1Q	250	5	22	20.9	23.1	55	5	250	1	0.05	15.4	
PZS52C24M1Q	250	5	24	22.8	25.2	70	5	250	1	0.05	16.8	
PZS52C27M1Q	250	5	27	25.65	28.35	80	2	300	0.5	0.05	18.9	
PZS52C30M1Q	250	5	30	28.5	31.5	80	2	300	0.5	0.05	21	
PZS52C33M1Q	250	5	33	31.35	34.65	80	2	325	0.5	0.05	23.1	
PZS52C36M1Q	250	5	36	34.2	37.8	90	2	350	0.5	0.05	25.2	
PZS52C39M1Q	250	5	39	37.05	40.95	90	2	350	0.5	0.05	27.3	
PZS52C43M1Q	250	5	43	40.85	45.15	100	2	375	0.5	0.05	30.1	
PZS52C47M1Q	250	5	47	44.65	49.35	170	2	375	0.5	0.05	32.9	
PZS113V9BES	150	5	3.9	3.71	4.1	-	0.05	-	-	5	2	SOD-523
PZS114V3BES	150	5	4.3	4.09	4.52	-	0.05	-	-	4	2	
PZS114V7BES	150	5	4.7	4.47	4.94	-	0.05	-	-	10	3	
PZS115V1BES	150	5	5.1	4.85	5.36	-	0.05	-	-	10	3	
PZS115V3BES	150	5	5.3	5.03	5.57	-	0.05	-	-	10	4	
PZS115V6BES	150	5	5.6	5.32	5.88	-	0.05	-	-	10	4	
PZS116V2BES	150	5	6.2	5.89	6.51	-	0.05	-	-	10	5	
PZS116V8BES	150	5	6.8	6.46	7.14	-	0.05	-	-	10	5.1	
PZS117V5BES	150	5	7.5	7.13	7.88	-	0.05	-	-	0.8	5.7	
PZS118V2BES	150	5	8.2	7.79	8.61	-	0.05	-	-	1	6.2	
PZS118V7BES	150	5	8.7	8.27	9.14	-	0.05	-	-	1	6.6	
PZS119V1BES	150	5	9.1	8.65	9.56	-	0.05	-	-	1	6.9	
PZS1110BES	150	5	10	9.5	10.5	-	0.05	-	-	1	7.6	SOD-523
PZS1111BES	150	5	11	10.5	11.6	-	0.05	-	-	0.05	8.4	
PZS1112BES	150	5	12	11.4	12.6	-	0.05	-	-	0.05	9.1	
PZS1113BES	150	5	13	12.4	13.7	-	0.05	-	-	0.05	9.8	
PZS1114BES	150	5	14	13.3	14.7	-	0.05	-	-	0.05	10.6	
PZS1115BES	150	5	15	14.3	15.8	-	0.05	-	-	0.05	11.4	
PZS1116BES	150	5	16	15.2	16.8	-	0.05	-	-	0.05	12.1	
PZS1117BES	150	5	17	16.2	17.9	-	0.05	-	-	0.05	12.9	
PZS1118BES	150	5	18	17.1	18.9	-	0.05	-	-	0.05	13.6	
PZS1119BES	150	5	19	18.1	20	-	0.05	-	-	0.05	14.4	
PZS1120BES	150	5	20	19	21	-	0.05	-	-	0.01	15.2	
PZS1122BES	150	5	22	20.9	23.1	-	0.05	-	-	0.01	16.7	
PZS1124BES	150	5	24	22.8	25.2	-	0.05	-	-	0.01	18.2	
PZS1125BES	150	5	25	23.8	26.3	-	0.05	-	-	0.01	19	
PZS1127BES	150	5	27	25.7	28.4	-	0.05	-	-	0.01	20.4	
PZS1128BES	150	5	28	26.6	29.4	-	0.05	-	-	0.01	21.2	
PZS1130BES	150	5	30	28.5	31.5	-	0.05	-	-	0.01	22.8	
PZS1133BES	150	5	33	31.4	34.7	-	0.05	-	-	0.01	25	
PZS1136BES	150	5	36	34.2	37.8	-	0.05	-	-	0.01	27.3	
PZS1139BES	150	5	39	37.1	41	-	0.05	-	-	0.01	29.6	
PZS1143BES	150	5	43	40.9	45.2	-	0.05	-	-	0.01	32.6	

Zener Diodes

Part Number	P _D	V _Z	V _Z @ I _{ZT} (V)			Z _{ZT} @ I _{ZT} Max.	I _{ZT}	Z _{ZK} @ I _{ZK} Max.	I _{ZK}	I _R @ V _R Max.		Package
	mW	%	Nom.	Min.	Max.	Ω	mA	Ω	mA	μA	V	
BZX584C2V4	200	5	2.4	2.28	2.52	100	5	600	1	50	1	SOD-523
MMBZ5221BV	200	5	2.4	2.28	2.52	30	20	1200	0.25	100	1	
MMBZ5222BV	200	5	2.5	2.375	2.625	30	20	1250	0.25	100	1	
BZX584C2V7	200	5	2.7	2.565	2.835	100	5	600	1	20	1	
MMBZ5223BV	200	5	2.7	2.565	2.835	30	20	1300	0.25	75	1	
BZX584C3	200	5	3	2.85	3.15	95	5	600	1	10	1	
MMBZ5225BV	200	5	3	2.85	3.15	30	20	1600	0.25	50	1	
BZX584C3V3	200	5	3.3	3.135	3.465	95	5	600	1	5	1	
MMBZ5226BV	200	5	3.3	3.135	3.465	28	20	1600	0.25	25	1	
BZX584C3V6	200	5	3.6	3.42	3.78	90	5	600	1	5	1	
MMBZ5227BV	200	5	3.6	3.42	3.78	24	20	1700	0.25	15	1	
BZX584C3V9	200	5	3.9	3.705	4.095	90	5	600	1	3	1	
MMBZ5228BV	200	5	3.9	3.705	4.095	23	20	1900	0.25	10	1	
BZX584C4V3	200	5	4.3	4.085	4.515	90	5	600	1	3	1	
MMBZ5229BV	200	5	4.3	4.085	4.515	22	20	2000	0.25	5	1	
BZX584C4V7	200	5	4.7	4.465	4.935	80	5	500	1	3	2	
MMBZ5230BV	200	5	4.7	4.465	4.935	19	20	1900	0.25	5	2	
BZX584B5V1	200	2	5.1	5	5.2	60	5	480	1	2	2	
BZX584C5V1	200	5	5.1	4.845	5.355	60	5	480	1	2	2	
MMBZ5231BV	200	5	5.1	4.845	5.355	17	20	1600	0.25	5	2	
BZX584B5V6	200	2	5.6	5.49	5.71	40	5	400	1	1	2	
BZX584C5V6	200	5	5.6	5.32	5.88	40	5	400	1	1	2	
MMBZ5232BV	200	5	5.6	5.32	5.88	11	20	1600	0.25	5	3	
BZX584C6V2	200	5	6.2	5.89	6.51	10	5	150	1	3	4	
MMBZ5234BV	200	5	6.2	5.89	6.51	7	20	1000	0.25	5	4	
BZX584C6V8	200	5	6.8	6.46	7.14	15	5	80	1	2	4	
MMBZ5235BV	200	5	6.8	6.46	7.14	5	20	750	0.25	3	5	
BZX584C7V5	200	5	7.5	7.125	7.875	15	5	80	1	1	5	
MMBZ5236BV	200	5	7.5	7.125	7.875	6	20	500	0.25	3	6	
BZX584B8V2	200	2	8.2	8.04	8.36	15	5	80	1	0.7	5	
BZX584C8V2	200	5	8.2	7.79	8.61	15	5	80	1	0.7	5	
MMBZ5237BV	200	5	8.2	7.79	8.61	8	20	500	0.25	3	6.5	
BZX584C8V7	200	5	8.7	8.265	9.135	15	5	100	1	0.7	5	
MMBZ5238BV	200	5	8.7	8.265	9.135	8	20	600	0.25	3	6.5	
BZX584C9V1	200	5	9.1	8.645	9.555	15	5	100	1	0.5	6	
MMBZ5239BV	200	5	9.1	8.645	9.555	10	20	600	0.25	3	7	
BZX584C10	200	5	10	9.5	10.5	20	5	150	1	0.2	7	
MMBZ5240BV	200	5	10	9.5	10.5	17	20	600	0.25	3	8	
BZX584C11	200	5	11	10.45	11.55	20	5	150	1	0.1	8	
MMBZ5241BV	200	5	11	10.45	11.55	22	20	600	0.25	2	8.4	
BZX584C12	200	5	12	11.4	12.6	25	5	150	1	0.1	8	

Zener Diodes

Part Number	P _D	V _Z	V _Z @ I _{ZT} (V)			Z _{ZT} @ I _{ZT} Max.	I _{ZT}	Z _{ZK} @ I _{ZK} Max.	I _{ZK}	I _R @ V _R Max.		Package
	mW	%	Nom.	Min.	Max.	Ω	mA	Ω	mA	μA	V	
MMBZ5242BV	200	5	12	11.4	12.6	30	20	600	0.25	1	9.1	SOD-523
BZX584C13	200	5	13	12.35	13.65	30	5	170	1	0.1	8	
MMBZ5243BV	200	5	13	12.35	13.65	13	9.5	600	0.25	0.5	9.9	
BZX584C14	200	5	14	13.3	14.7	30	5	170	1	0.05	10	
MMBZ5244BV	200	5	14	13.3	14.7	15	9	600	0.25	0.1	10.5	
BZX584C15	200	5	15	14.25	15.75	30	5	200	1	0.05	10.5	
MMBZ5245BV	200	5	15	14.25	15.75	16	8.5	600	0.25	0.1	11	
BZX584C16	200	5	16	15.2	16.8	40	5	200	1	0.05	11.2	
MMBZ5246BV	200	5	16	15.2	16.8	17	7.8	600	0.25	0.1	12	
BZX584C17	200	5	17	16.15	17.85	40	5	200	1	0.05	12.2	
MMBZ5247BV	200	5	17	16.15	17.85	19	7.5	600	0.25	0.1	13	
BZX584C18	200	5	18	17.1	18.9	45	5	225	1	0.05	12.6	
MMBZ5248BV	200	5	18	17.1	18.9	21	7	600	0.25	0.1	14	
BZX584C20	200	5	20	19	21	55	5	225	1	0.05	14	
MMBZ5250BV	200	5	20	19	21	25	6.2	600	0.25	0.1	15	
BZX584C22	200	5	22	20.9	23.1	55	5	250	1	0.05	15.4	
MMBZ5251BV	200	5	22	20.9	23.1	29	5.6	600	0.25	0.1	17	
BZX584C24	200	5	24	22.8	25.2	70	5	250	1	0.1	16.8	
MMBZ5252BV	200	5	24	22.8	25.2	33	5.2	600	0.25	0.1	18	
BZX584C27	200	5	27	25.65	28.35	80	5	300	1	0.1	18.9	
MMBZ5254BV	200	5	27	25.65	28.35	41	5	600	0.25	0.1	21	
BZX584C28	200	5	28	26.6	29.4	80	5	300	1	0.1	20.5	
MMBZ5255BV	200	5	28	26.6	29.4	44	4.5	600	0.25	0.1	21	
BZX584C30	200	5	30	28.5	31.5	80	5	300	1	0.1	21	
MMBZ5256BV	200	5	30	28.5	31.5	49	4.2	600	0.25	0.1	23	
BZX584C33	200	5	33	31.35	34.65	80	5	325	1	0.1	23.1	
MMBZ5257BV	200	5	33	31.35	34.65	58	3.8	700	0.25	0.1	25	
BZX584C36	200	5	36	34.2	37.8	90	5	350	1	0.1	25.2	
MMBZ5258BV	200	5	36	34.2	37.8	70	3.4	700	0.25	0.1	27	
BZX584C39	200	5	39	37.05	40.95	130	5	350	1	0.1	27.3	
MMBZ5259BV	200	5	39	37.05	40.95	80	3.2	800	0.25	0.1	30	
BZX584C43	200	5	43	40.85	45.15	150	5	375	1	0.1	30.1	
MMBZ5260BV	200	5	43	40.85	45.15	93	3	900	0.25	0.1	33	
BZX584C47	200	5	47	44.65	49.35	170	5	375	1	0.1	32.9	
MMBZ5261BV	200	5	47	44.65	49.35	105	2.7	1000	0.25	0.1	36	
BZX584C51	200	5	51	48.45	53.55	100	5	400	1	0.1	38	
MMBZ5262BV	200	5	51	48.45	53.55	125	2.5	1100	0.25	0.1	39	
BZX584C56	200	5	56	53.2	58.8	135	2.5	1000	1	0.1	42	
BZX584C62	200	5	62	58.9	65.1	150	2.5	1000	1	0.1	46	
BZX584C68	200	5	68	64.6	71.4	200	2.5	1000	1	0.1	51	
BZX584C75	200	5	75	71.25	78.75	250	2.5	1000	1	0.1	56	

Zener Diodes

Part Number	P _D	V _Z	V _Z @ I _{ZT} (V)			Z _{ZT} @ I _{ZT} Max.	I _{ZT}	Z _{ZK} @ I _{ZK} Max.	I _{ZK}	I _R @ V _R Max.		Package
	mW	%	Nom.	Min.	Max.	Ω	mA	Ω	mA	μA	V	
BZT52-B2V4S	200	2	2.4	2.352	2.448	85	5	600	1	0.1	1	SOD-323
BZT52-C2V4S	200	5	2.4	2.28	2.52	85	5	600	1	0.1	1	
MMSZ5221BS	200	5	2.4	2.28	2.52	30	20	1200	0.25	0.1	1	
MMSZ5222BS	200	5	2.5	2.38	2.63	30	20	1250	0.25	0.1	1	
BZT52-B2V7S	200	2	2.7	2.64	2.754	83	5	600	1	0.1	1	
BZT52-C2V7S	200	5	2.7	2.57	2.84	83	5	600	1	0.1	1	
MMSZ5223BS	200	5	2.7	2.57	2.84	30	20	1300	0.25	0.1	1	
BZT52-B3S	200	2	3	2.94	3.06	95	5	600	1	0.1	1	
BZT52-C3S	200	5	3	2.85	3.15	95	5	600	1	0.1	1	
MMSZ5225BS	200	5	3	2.85	3.15	30	20	1600	0.25	0.1	1	
BZT52-B3V3S	200	2	3.3	3.234	3.366	95	5	600	1	25	1	
BZT52-C3V3S	200	5	3.3	3.14	3.47	95	5	600	1	25	1	
MMSZ5226BS	200	5	3.3	3.14	3.47	28	20	1600	0.25	25	1	
BZT52-B3V6S	200	2	3.6	3.52	3.672	95	5	600	1	15	1	
BZT52-C3V6S	200	5	3.6	3.42	3.78	95	5	600	1	15	1	
MMSZ5227BS	200	5	3.6	3.42	3.78	24	20	1700	0.25	15	1	
BZT52-B3V9S	200	2	3.9	3.822	3.978	95	5	600	1	10	1	
BZT52-C3V9S	200	5	3.9	3.71	4.1	95	5	600	1	10	1	
MMSZ5228BS	200	5	3.9	3.71	4.1	23	20	1900	0.25	10	1	
PZS51A3V9CS	200	2	3.9	3.82	3.98	-	0.05	-	-	5	2	
BZT52-B4V3S	200	2	4.3	4.21	4.39	95	5	600	1	5	1	
BZT52-C4V3S	200	5	4.3	4.09	4.52	95	5	600	1	5	1	
MMSZ5229AS	200	2	4.3	4.21	4.39	22	20	2000	0.25	5	1	
MMSZ5229BS	200	5	4.3	4.09	4.52	22	20	2000	0.25	5	1	
PZS51A4V3CS	200	2	4.3	4.21	4.39	-	0.05	-	-	4	2	
BZT52-B4V7S	200	2	4.7	4.61	4.79	78	5	500	1	5	1	
BZT52-C4V7S	200	5	4.7	4.47	4.94	78	5	500	1	5	1	
MMSZ5230AS	200	2	4.7	4.61	4.79	19	20	1900	0.25	5	2	
MMSZ5230BS	200	5	4.7	4.47	4.94	19	20	1900	0.25	5	2	
PZS51A4V7CS	200	2	4.7	4.61	4.79	-	0.05	-	-	10	3	
BZT52-B5V1S	200	2	5.1	5	5.2	60	5	480	1	0.1	0.8	
BZT52-C5V1S	200	5	5.1	4.85	5.36	60	5	480	1	0.1	0.8	
MMSZ5231AS	200	2	5.1	5	5.2	17	20	1600	0.25	5	2	
MMSZ5231BS	200	5	5.1	4.85	5.36	17	20	1600	0.25	5	2	
PZS51A5V1CS	200	2	5.1	5	5.2	-	0.05	-	-	10	3	
PZS51A5V3CS	200	2	5.3	5.19	5.41	-	0.05	-	-	10	4	
BZT52-B5V6S	200	2	5.6	5.49	5.71	40	5	400	1	0.1	1	
BZT52-C5V6S	200	5	5.6	5.32	5.88	40	5	400	1	0.1	1	
MMSZ5232AS	200	2	5.6	5.49	5.71	11	20	1600	0.25	5	3	
MMSZ5232BS	200	5	5.6	5.32	5.88	11	20	1600	0.25	5	3	
PZS51A5V6CS	200	2	5.6	5.49	5.71	-	0.05	-	-	7	4.2	
BZT52-B5V8S	200	2	5.8	5.68	5.92	30	5	300	1	0.1	1.5	
BZT52-B6V2S	200	2	6.2	6.08	6.32	10	5	150	1	0.1	2	
BZT52-C6V2S	200	5	6.2	5.89	6.51	10	5	150	1	0.1	2	
MMSZ4691WS	200	5	6.2	5.89	6.61	-	0.05	-	-	10	5	
MMSZ5234AS	200	2	6.2	6.08	6.32	7	20	1000	0.25	5	4	
MMSZ5234BS	200	5	6.2	5.89	6.51	7	20	1000	0.25	5	4	
PZS51A6V2CS	200	2	6.2	6.08	6.32	-	0.05	-	-	10	5	
BZT52-B6V8S	200	2	6.8	6.66	6.94	8	5	80	1	0.1	3	
BZT52-C6V8S	200	5	6.8	6.46	7.14	8	5	80	1	0.1	3	
MMSZ4692WS	200	5	6.8	6.46	7.14	-	0.05	-	-	10	5.1	
MMSZ5235AS	200	2	6.8	6.66	6.94	5	20	750	0.25	3	5	
MMSZ5235BS	200	5	6.8	6.46	7.14	5	20	750	0.25	3	5	
PZS51A6V8CS	200	2	6.8	6.66	6.94	-	0.05	-	-	10	5.1	
BZT52-B7V5S	200	2	7.5	7.35	7.65	7	5	80	1	0.1	5	

Zener Diodes

Part Number	P _D	V _Z	V _Z @ I _{ZT} (V)			Z _{VT} @ I _{ZT} Max.	I _{ZT}	Z _{ZK} @ I _{ZK} Max.	I _{ZK}	I _R @ V _R Max.		Package
	mW	%	Nom.	Min.	Max.	Ω	mA	Ω	mA	μA	V	
BZT52-C7V5S	200	5	7.5	7.13	7.88	7	5	80	1	0.1	5	SOD-323
MMSZ5236AS	200	2	7.5	7.35	7.65	6	20	500	0.25	3	6	
MMSZ5236BS	200	5	7.5	7.13	7.88	6	20	500	0.25	3	6	
PZS51A7V5CS	200	2	7.5	7.35	7.65	-	0.05	-	-	10	5.7	
BZT52-B8V2S	200	2	8.2	8.04	8.36	7	5	80	1	0.1	6	
BZT52-C8V2S	200	5	8.2	7.79	8.61	7	5	80	1	0.1	6	
MMSZ5237AS	200	2	8.2	8.04	8.36	8	20	500	0.25	3	6	
MMSZ5237BS	200	5	8.2	7.79	8.61	8	20	500	0.25	3	6	
PZS51A8V2CS	200	2	8.2	8.04	8.36	-	0.05	-	-	1	6.2	
BZT52-B8V7S	200	2	8.7	8.53	8.87	7	5	100	1	0.1	6.5	
BZT52-C8V7S	200	5	8.7	8.27	9.14	7	5	100	1	0.1	6.5	
MMSZ5238AS	200	2	8.7	8.53	8.87	8	20	600	0.25	3	6.5	
MMSZ5238BS	200	5	8.7	8.27	9.14	8	20	600	0.25	3	6.5	
PZS51A8V7CS	200	2	8.7	8.53	8.87	-	0.05	-	-	1	6.6	
BZT52-B9V1S	200	2	9.1	8.92	9.28	10	5	100	1	0.1	7	
BZT52-C9V1S	200	5	9.1	8.65	9.56	10	5	100	1	0.1	7	
MMSZ5239AS	200	2	9.1	8.92	9.28	10	20	600	0.25	3	6.5	
MMSZ5239BS	200	5	9.1	8.65	9.56	10	20	600	0.25	3	6.5	
PZS51A9V1CS	200	2	9.1	8.92	9.28	-	0.05	-	-	1	6.9	
BZT52-B10S	200	2	10	9.8	10.2	15	5	150	1	0.1	7.5	
BZT52-C10S	200	5	10	9.5	10.5	15	5	150	1	0.1	7.5	
MMSZ5240AS	200	2	10	9.8	10.2	17	20	600	0.25	3	8	
MMSZ5240BS	200	5	10	9.5	10.5	17	20	600	0.25	3	8	
PZS51A10CS	200	2	10	9.8	10.2	-	0.05	-	-	1	7.6	
BZT52-B11S	200	2	11	10.78	11.22	20	5	150	1	0.1	8.5	
BZT52-C11S	200	5	11	10.45	11.55	20	5	150	1	0.1	8.5	
MMSZ5241AS	200	2	11	10.78	11.22	22	20	600	0.25	2	8.4	
MMSZ5241BS	200	5	11	10.45	11.55	22	20	600	0.25	2	8.4	
PZS51A11CS	200	2	11	10.78	11.22	-	0.05	-	-	0.05	8.4	
BZT52-B12S	200	2	12	11.76	12.24	20	5	150	1	0.1	9	
BZT52-C12S	200	5	12	11.4	12.6	20	5	150	1	0.1	9	
MMSZ5242AS	200	2	12	11.76	12.24	30	20	600	0.25	1	9.1	
MMSZ5242BS	200	5	12	11.4	12.6	30	20	600	0.25	1	9.1	
PZS51A12CS	200	2	12	11.76	12.24	-	0.05	-	-	0.05	9.1	
BZT52-B13S	200	2	13	12.74	13.26	25	5	170	1	0.1	10	
BZT52-C13S	200	5	13	12.35	13.65	25	5	170	1	0.1	10	
MMSZ5243AS	200	2	13	12.74	13.26	13	9.5	600	0.25	0.5	9.9	
MMSZ5243BS	200	5	13	12.35	13.65	13	9.5	600	0.25	0.5	9.9	
PZS51A13CS	200	2	13	12.74	13.26	-	0.05	-	-	0.05	9.8	
BZT52-B14S	200	2	14	13.72	14.28	25	5	170	1	0.1	10.5	
BZT52-C14S	200	5	14	13.3	14.7	25	5	170	1	0.1	10.5	
MMSZ5244AS	200	2	14	13.72	14.28	15	9	600	0.25	0.1	10.5	
MMSZ5244BS	200	5	14	13.3	14.7	15	9	600	0.25	0.1	10.5	
PZS51A14CS	200	2	14	13.72	14.28	-	0.05	-	-	0.05	10.6	
BZT52-B15S	200	2	15	14.7	15.3	30	5	200	1	0.1	11	
BZT52-C15S	200	5	15	14.25	15.75	30	5	200	1	0.1	11	
MMSZ4702WS	200	5	15	14.25	15.75	-	0.05	-	-	0.05	11.4	
MMSZ5245AS	200	2	15	14.7	15.3	16	8.5	600	0.25	0.1	11	
MMSZ5245BS	200	5	15	14.25	15.75	16	8.5	600	0.25	0.1	11	
PZS51A15CS	200	2	15	14.7	15.3	-	0.05	-	-	0.05	11.4	
BZT52-B16S	200	2	16	15.68	16.32	40	5	200	1	0.1	12	
BZT52-C16S	200	5	16	15.2	16.8	40	5	200	1	0.1	12	
MMSZ5246AS	200	2	16	15.68	16.32	17	7.8	600	0.25	0.1	12	
MMSZ5246BS	200	5	16	15.2	16.8	17	7.8	600	0.25	0.1	12	
PZS51A16CS	200	2	16	15.68	16.32	-	0.05	-	-	0.05	12.1	

Zener Diodes

Part Number	P _D	V _Z	V _Z @ I _{ZT} (V)			Z _{ZT} @ I _{ZT} Max.	I _{ZT}	Z _{ZK} @ I _{ZK} Max.	I _{ZK}	I _R @ V _R Max.		Package
	mW	%	Nom.	Min.	Max.	Ω	mA	Ω	mA	μA	V	
BZT52-B17S	200	2	17	16.66	17.34	40	5	200	1	0.1	13	SOD-323
BZT52-C17S	200	5	17	16.15	17.85	40	5	200	1	0.1	13	
MMSZ5247AS	200	2	17	16.66	17.34	19	7.5	600	0.25	0.1	13	
MMSZ5247BS	200	5	17	16.15	17.85	19	7.5	600	0.25	0.1	13	
PZS51A17CS	200	2	17	16.66	17.34	-	0.05	-	-	0.05	12.9	
BZT52-B18S	200	2	18	17.64	18.36	50	5	225	1	0.1	14	
BZT52-C18S	200	5	18	17.1	18.9	50	5	225	1	0.1	14	
MMSZ5248AS	200	2	18	17.64	18.36	21	7	600	0.25	0.1	14	
MMSZ5248BS	200	5	18	17.1	18.9	21	7	600	0.25	0.1	14	
PZS51A18CS	200	2	18	17.64	18.36	-	0.05	-	-	0.05	13.6	
PZS51A19CS	200	2	19	18.62	19.38	-	0.05	-	-	0.05	14.4	
BZT52-B20S	200	2	20	19.6	20.4	50	5	225	1	0.1	15	
BZT52-C20S	200	5	20	19	21	50	5	225	1	0.1	15	
MMSZ5250AS	200	2	20	19.6	20.4	25	6.2	600	0.25	0.1	15	
MMSZ5250BS	200	5	20	19	21	25	6.2	600	0.25	0.1	15	
PZS51A20CS	200	2	20	19.6	20.4	-	0.05	-	-	0.01	15.2	
BZT52-B22S	200	2	22	21.56	22.44	55	5	250	1	0.1	17	
BZT52-C22S	200	5	22	20.9	23.1	55	5	250	1	0.1	17	
MMSZ5251AS	200	2	22	21.56	22.44	29	5.6	600	0.25	0.1	17	
MMSZ5251BS	200	5	22	20.9	23.1	29	5.6	600	0.25	0.1	17	
PZS51A22CS	200	2	22	21.56	22.44	-	0.05	-	-	0.01	16.7	
BZT52-B24S	200	2	24	23.52	24.48	80	5	250	1	0.1	18	
BZT52-C24S	200	5	24	22.8	25.2	80	5	250	1	0.1	18	
MMSZ5252AS	200	2	24	23.52	24.48	33	5.2	600	0.25	0.1	18	
MMSZ5252BS	200	5	24	22.8	25.2	33	5.2	600	0.25	0.1	18	
PZS51A24CS	200	2	24	23.52	24.48	-	0.05	-	-	0.01	18.2	
PZS51A25CS	200	2	25	24.5	25.5	-	0.05	-	-	0.01	19	
BZT52-B27S	200	2	27	26.46	27.54	80	5	300	1	0.1	20	
BZT52-C27S	200	5	27	25.65	28.35	80	5	300	1	0.1	20	
MMSZ5254AS	200	2	27	26.46	27.54	41	5	600	0.25	0.1	21	
MMSZ5254BS	200	5	27	25.65	28.35	41	5	600	0.25	0.1	21	
PZS51A27CS	200	2	27	26.46	27.54	-	0.05	-	-	0.01	20.4	
BZT52-B28S	200	2	28	27.44	28.56	80	5	300	1	0.1	22	
BZT52-C28S	200	5	28	26.6	29.4	80	5	300	1	0.1	22	
MMSZ5255AS	200	2	28	27.44	28.56	44	4.5	600	0.25	0.1	21	
MMSZ5255BS	200	5	28	26.6	29.4	44	4.5	600	0.25	0.1	21	
PZS51A28CS	200	2	28	27.44	28.56	-	0.05	-	-	0.01	21.2	
BZT52-B30S	200	2	30	29.4	30.6	80	5	300	1	0.1	22.5	
BZT52-C30S	200	5	30	28.5	31.5	80	5	300	1	0.1	22.5	
MMSZ5256AS	200	2	30	29.4	30.6	49	4.2	600	0.25	0.1	23	
MMSZ5256BS	200	5	30	28.5	31.5	49	4.2	600	0.25	0.1	23	
PZS51A30CS	200	2	30	29.4	30.6	-	0.05	-	-	0.01	22.8	
BZT52-B33S	200	2	33	32.34	33.66	80	5	325	1	0.1	25	
BZT52-C33S	200	5	33	31.35	34.65	80	5	325	1	0.1	25	
MMSZ5257AS	200	2	33	32.34	33.66	58	3.8	700	0.25	0.1	25	
MMSZ5257BS	200	5	33	31.35	34.65	58	3.8	700	0.25	0.1	25	
PZS51A33CS	200	2	33	32.34	33.66	-	0.05	-	-	0.01	25	
BZT52-B36S	200	2	36	35.28	36.72	90	5	350	1	0.1	27	
BZT52-C36S	200	5	36	34.2	37.8	90	5	350	1	0.1	27	
MMSZ5258AS	200	2	36	35.28	36.72	70	3.4	700	0.25	0.1	27	

Zener Diodes

Part Number	P _D	V _Z	V _Z @ I _{ZT} (V)			Z _{ZT} @ I _{ZT} Max.	I _{ZT}	Z _{ZK} @ I _{ZK} Max.	I _{ZK}	I _R @ V _R Max.		Package
	mW	%	Nom.	Min.	Max.	Ω	mA	Ω	mA	μA	V	
MMSZ5258BS	200	5	36	34.2	37.8	70	3.4	700	0.25	0.1	27	SOD-323
PZS51A36CS	200	2	36	35.28	36.72	-	0.05	-	-	0.01	27.3	
BZT52-B39S	200	2	39	38.22	39.78	90	5	350	1	0.1	29	
BZT52-C39S	200	5	39	37.05	40.95	90	5	350	1	0.1	29	
MMSZ5259AS	200	2	39	38.22	39.78	80	3.2	800	0.25	0.1	30	
MMSZ5259BS	200	5	39	37.05	40.95	80	3.2	800	0.25	0.1	30	
PZS51A39CS	200	2	39	38.22	39.78	-	0.05	-	-	0.01	29.6	
BZT52-B43S	200	2	43	42.14	43.86	100	5	375	1	0.1	32	
BZT52-C43S	200	5	43	40.85	45.15	100	5	375	1	0.1	32	
MMSZ5260AS	200	2	43	42.14	43.86	93	3	900	0.25	0.1	33	
MMSZ5260BS	200	5	43	40.85	45.15	93	3	900	0.25	0.1	33	
PZS51A43CS	200	2	43	42.14	43.86	-	0.05	-	-	0.01	32.6	
BZT52-B47S	200	2	47	46.06	47.94	100	5	375	1	0.1	35	
BZT52-C47S	200	5	47	44.65	49.35	100	5	375	1	0.1	35	
MMSZ5261AS	200	2	47	46.06	47.94	105	2.7	1000	0.25	0.1	36	
MMSZ5261BS	200	5	47	44.65	49.35	105	2.7	1000	0.25	0.1	36	
BZT52-B51S	200	2	51	49.98	52.02	100	5	400	1	0.1	38	
BZT52-C51S	200	5	51	48.45	53.55	100	5	400	1	0.1	38	
MMSZ5262AS	200	2	51	49.98	52.02	125	2.5	1100	0.25	0.1	39	
MMSZ5262BS	200	5	51	48.45	53.55	125	2.5	1100	0.25	0.1	39	
BZT52-B56S	200	2	56	54.88	57.12	135	2.5	1000	1	0.1	42	
BZT52-C56S	200	5	56	53.2	58.8	135	2.5	1000	1	0.1	42	
BZT52-B62S	200	2	62	60.76	63.24	150	2.5	1000	1	0.1	46	
BZT52-C62S	200	5	62	58.9	65.1	150	2.5	1000	1	0.1	46	
BZT52-B68S	200	2	68	66.64	69.36	200	2.5	1000	1	0.1	51	
BZT52-C68S	200	5	68	64.6	71.4	200	2.5	1000	1	0.1	51	
BZT52-B75S	200	2	75	73.5	76.5	250	2.5	1000	1	0.1	56	
BZT52-C75S	200	5	75	71.25	78.75	250	2.5	1000	1	0.1	56	
PDZ4.7B	400	2	4.7	4.55	4.75	90	5	600	1	0.75	1.5	
PDZ5.1B	400	2	5.1	4.96	5.2	60	5	800	0.5	0.75	1.5	
PDZ5.6B	400	2	5.6	5.48	5.73	50	5	400	0.5	0.5	3	
PDZ6.2B	400	2	6.2	6.06	6.33	50	5	80	0.5	0.5	3	
PDZ6.8B	400	2	6.8	6.65	6.93	40	5	60	0.5	0.5	3.5	
PDZ7.5B	400	2	7.4	7.28	7.6	10	5	60	0.5	0.5	4	
PDZ8.2B	400	2	8.2	8.02	8.36	10	5	60	0.5	0.5	5	
PDZ9.1B	400	2	9	8.85	9.23	10	5	60	0.5	0.5	6	
PDZ10B	400	2	10	9.77	10.21	10	5	60	0.5	0.1	7	
PDZ11B	400	2	11	10.78	11.22	10	5	60	0.5	0.1	8	
PDZ12B	400	2	12	11.74	12.24	10	5	80	0.5	0.1	9	
PDZ13B	400	2	13.2	12.91	13.49	10	5	80	0.5	0.1	10	
PDZ15B	400	2	14.7	14.34	14.98	15	5	80	0.5	0.05	11	
PDZ16B	400	2	16.2	15.85	16.51	20	5	80	0.5	0.05	12	
PDZ18B	400	2	18	17.56	18.35	20	5	80	0.5	0.05	13	
PDZ20B	400	2	20	19.52	20.39	20	5	100	0.5	0.05	15	
PDZ22B	400	2	22	21.54	22.47	25	5	100	0.5	0.05	17	
PDZ24B	400	2	24.3	23.72	24.78	30	5	120	0.5	0.05	19	
PDZ27B	400	2	26.9	26.19	27.53	40	5	150	0.5	0.05	21	
PDZ30B	400	2	29.9	29.19	30.69	40	5	200	0.5	0.05	23	
PDZ33B	400	2	33	32.15	33.79	40	5	250	0.5	0.05	25	
PDZ36B	400	2	36	35.07	36.87	60	5	300	0.5	0.05	27	

Zener Diodes

Part Number	P _D	V _Z	V _Z @ I _{ZT} (V)			Z _{VT} @ I _{ZT} Max.	I _{ZT}	Z _{ZK} @ I _{ZK} Max.	I _{ZK}	I _R @ V _R Max.		Package
	mW	%	Nom.	Min.	Max.	Ω	mA	Ω	mA	μA	V	
PZS513V9BCH	500	5	3.9	3.71	4.1	-	0.05	-	-	5	2	SOD-323HE
PZS514V3BCH	500	5	4.3	4.09	4.52	-	0.05	-	-	4	2	
PZS524V3BCH	500	5	4.3	4.08	4.52	95	5	600	1	5	1	
PZS514V7BCH	500	5	4.7	4.47	4.94	-	0.05	-	-	10	3	
PZS524V7BCH	500	5	4.7	4.46	4.94	78	5	500	1	5	1	
PZS515V1BCH	500	5	5.1	4.85	5.36	-	0.05	-	-	10	3	
PZS525V1BCH	500	5	5.1	4.84	5.36	60	5	480	1	0.1	0.8	
PZS515V3BCH	500	5	5.3	5.03	5.57	-	0.05	-	-	10	4	
PZS515V6BCH	500	5	5.6	5.32	5.88	-	0.05	-	-	7	4.2	
PZS525V6BCH	500	5	5.6	5.32	5.88	40	5	400	1	0.1	1	
PZS516V2BCH	500	5	6.2	5.89	6.51	-	0.05	-	-	10	5	
PZS526V2BCH	500	5	6.2	5.89	6.51	10	5	150	1	0.1	2	
PZS516V8BCH	500	5	6.8	6.46	7.14	-	0.05	-	-	10	5.1	
PZS526V8BCH	500	5	6.8	6.46	7.14	8	5	80	1	0.1	3	
PZS517V5BCH	500	5	7.5	7.13	7.88	-	0.05	-	-	10	5.7	
PZS527V5BCH	500	5	7.5	7.12	7.88	7	5	80	1	0.1	5	
PZS518V2BCH	500	5	8.2	7.79	8.61	-	0.05	-	-	1	6.2	
PZS528V2BCH	500	5	8.2	7.79	8.61	7	5	80	1	0.1	6	
PZS518V7BCH	500	5	8.7	8.27	9.14	-	0.05	-	-	1	6.6	
PZS528V7BCH	500	5	8.7	8.26	9.14	7	5	100	1	0.1	6.5	
PZS519V1BCH	500	5	9.1	8.65	9.56	-	0.05	-	-	1	6.9	
PZS529V1BCH	500	5	9.1	8.64	9.56	10	5	100	1	0.1	7	
PZS5110BCH	500	5	10	9.5	10.5	-	0.05	-	-	1	7.6	
PZS5210BCH	500	5	10	9.5	10.5	15	5	150	1	0.1	7.5	
PZS5111BCH	500	5	11	10.5	11.6	-	0.05	-	-	0.05	8.4	
PZS5211BCH	500	5	11	10.45	11.55	20	5	150	1	0.1	8.5	
PZS5112BCH	500	5	12	11.4	12.6	-	0.05	-	-	0.05	9.1	
PZS5212BCH	500	5	12	11.4	12.6	20	5	150	1	0.1	9	
PZS5113BCH	500	5	13	12.4	13.7	-	0.05	-	-	0.05	9.8	
PZS5213BCH	500	5	13	12.35	13.65	25	5	170	1	0.1	10	
PZS5114BCH	500	5	14	13.3	14.7	-	0.05	-	-	0.05	10.6	
PZS5214BCH	500	5	14	13.3	14.7	25	5	170	1	0.1	10.5	
PZS5115BCH	500	5	15	14.3	15.8	-	0.05	-	-	0.05	11.4	
PZS5215BCH	500	5	15	14.25	15.75	30	5	200	1	0.1	11	
PZS5116BCH	500	5	16	15.2	16.8	-	0.05	-	-	0.05	12.1	
PZS5216BCH	500	5	16	15.2	16.8	40	5	200	1	0.1	12	
PZS5117BCH	500	5	17	16.2	17.9	-	0.05	-	-	0.05	12.9	
PZS5217BCH	500	5	17	16.15	17.85	40	5	200	1	0.1	13	
PZS5118BCH	500	5	18	17.1	18.9	-	0.05	-	-	0.05	13.6	
PZS5218BCH	500	5	18	17.1	18.9	50	5	225	1	0.1	14	
PZS5119BCH	500	5	19	18.1	20	-	0.05	-	-	0.05	14.4	
PZS5120BCH	500	5	20	19	21	-	0.05	-	-	0.01	15.2	
PZS5220BCH	500	5	20	19	21	50	5	220	1	0.1	15	
PZS5122BCH	500	5	22	20.9	23.1	-	0.05	-	-	0.01	16.7	
PZS5222BCH	500	5	22	20.9	23.1	55	5	250	1	0.1	17	
PZS5124BCH	500	5	24	22.8	25.2	-	0.05	-	-	0.01	18.2	
PZS5224BCH	500	5	24	22.8	25.2	80	5	250	1	0.1	18	
PZS5125BCH	500	5	25	23.8	26.3	-	0.05	-	-	0.01	19	
PZS5127BCH	500	5	27	25.7	28.4	-	0.05	-	-	0.01	20.4	
PZS5227BCH	500	5	27	25.65	28.35	80	5	300	1	0.1	20	
PZS5128BCH	500	5	28	26.6	29.4	-	0.05	-	-	0.01	21.2	
PZS5228BCH	500	5	28	26.6	29.4	80	5	300	1	0.1	22	
PZS5130BCH	500	5	30	28.5	31.5	-	0.05	-	-	0.01	22.8	
PZS5230BCH	500	5	30	28.5	31.5	80	5	300	1	0.1	22.5	
PZS5133BCH	500	5	33	31.4	34.7	-	0.05	-	-	0.01	25	
PZS5233BCH	500	5	33	31.35	34.65	80	5	325	1	0.1	25	
PZS5136BCH	500	5	36	34.2	37.8	-	0.05	-	-	0.01	27.3	
PZS5236BCH	500	5	36	34.2	37.8	90	5	350	1	0.1	27	
PZS5139BCH	500	5	39	37.1	41	-	0.05	-	-	0.01	29.6	
PZS5239BCH	500	5	39	37.05	40.95	90	5	350	1	0.1	29	

Zener Diodes

Part Number	P _D	V _Z	V _Z @ I _{ZT} (V)			Z _{ZT} @ I _{ZT} Max.	I _{ZT}	Z _{ZK} @ I _{ZK} Max.	I _{ZK}	I _R @ V _R Max.		Package
	mW	%	Nom.	Min.	Max.	Ω	mA	Ω	mA	μA	V	
PZS5143BCH	500	5	43	40.9	45.2	-	0.05	-	-	0.01	32.6	SOD-323HE
PZS5243BCH	500	5	43	40.85	45.15	100	5	375	1	0.1	32	
PZS5247BCH	500	5	47	44.65	49.35	100	5	375	1	0.1	35	
PZS5251BCH	500	5	51	48.45	53.55	100	5	400	1	0.1	38	
PZS5256BCH	500	5	56	53.2	58.8	135	2.5	1000	1	0.1	42	
PZS5262BCH	500	5	62	58.9	65.1	150	2.5	1000	1	0.1	46	
PZS5268BCH	500	5	68	64.6	71.4	200	2.5	1000	1	0.1	51	
PZS5275BCH	500	5	75	71.25	78.75	250	2.5	1000	1	0.1	56	
PZ1AL2V5B	1000	5	2.5	2.37	2.63	15	40	1500	1	200	0.7	SOD-123FL
PZ1AL3V6B	1000	5	3.6	3.42	3.78	8	100	400	1	100	1	
PZ1AL3V9B	1000	5	3.9	3.71	4.1	8	100	400	1	50	1	
PZ1AL4V3B	1000	5	4.3	4.09	4.52	7	100	400	1	25	1	
PZ1AL4V7B	1000	5	4.7	4.47	4.94	7	100	400	1	10	1	
PZ1AL5V1B	1000	5	5.1	4.85	5.36	6	100	550	1	5	1	
PZ1AL5V6B	1000	5	5.6	5.32	5.88	4	100	600	1	10	2	
PZ1AL6V0B	1000	5	6	5.7	6.3	3	100	600	1	8	2	
PZ1AL6V2B	1000	5	6.2	5.89	6.51	3	100	700	1	5	2	
PZ1AL6V8B	1000	5	6.8	6.46	7.14	3	100	700	1	10	3	
PZ1AL7V5B	1000	5	7.5	7.13	7.88	2	100	700	0.5	50	3	
PZ1AL8V2B	1000	5	8.2	7.79	8.61	2	100	700	0.5	10	3	
PZ1AL8V7B	1000	5	8.7	8.27	9.14	3	50	700	0.5	10	4	
PZ1AL9V1B	1000	5	9.1	8.65	9.56	4	50	700	0.5	10	5	
PZ1AL10B	1000	5	10	9.5	10.5	4	50	700	0.25	7	7.5	
PZ1AL11B	1000	5	11	10.45	11.55	7	50	700	0.25	4	8.2	
PZ1AL12B	1000	5	12	11.4	12.6	7	50	700	0.25	3	9.1	
PZ1AL13B	1000	5	13	12.35	13.65	10	50	700	0.25	2	10	
PZ1AL14B	1000	5	14	13.3	14.7	10	50	700	0.25	2	11	
PZ1AL15B	1000	5	15	14.25	15.75	10	50	700	0.25	1	11	
PZ1AL16B	1000	5	16	15.2	16.8	15	25	700	0.25	1	12	
PZ1AL17B	1000	5	17	16.15	17.85	15	25	750	0.25	1	13	
PZ1AL18B	1000	5	18	17.1	18.9	15	25	750	0.25	1	13	
PZ1AL19B	1000	5	19	18.05	19.95	15	25	750	0.25	1	14	
PZ1AL20B	1000	5	20	19	21	15	25	750	0.25	1	15	
AZD27C21	1000	5	21	20	22.4	15	20	750	0.25	10	15	
PZ1AL22B	1000	5	22	20.9	23.1	15	25	750	0.25	1	16	
PZ1AL24B	1000	5	24	22.8	25.2	15	25	750	0.25	1	18	
PZ1AL25B	1000	5	25	23.75	26.25	15	25	750	0.25	1	19	
PZ1AL27B	1000	5	27	25.65	28.35	15	25	750	0.25	1	20	
PZ1AL28B	1000	5	28	26.6	29.4	15	25	1000	0.25	1	21	
PZ1AL30B	1000	5	30	28.5	31.5	15	25	1000	0.25	1	22	
PZ1AL33B	1000	5	33	31.35	34.65	15	25	1000	0.25	1	24	
PZ1AL36B	1000	5	36	34.2	37.8	40	10	1000	0.25	1	27	
PZ1AL39B	1000	5	39	37.05	40.95	40	10	1000	0.25	1	30	
PZ1AL43B	1000	5	43	40.85	45.15	45	10	1500	0.25	1	33	
PZ1AL47B	1000	5	47	44.65	49.35	45	10	1500	0.25	1	36	
PZ1AL51B	1000	5	51	48.45	53.55	60	10	1500	0.25	1	39	
PZ1AL56B	1000	5	56	53.2	58.8	60	10	2000	0.25	1	43	
PZ1AL62B	1000	5	62	58.9	65.1	80	10	2000	0.25	1	47	
PZ1AL68B	1000	5	68	64.6	71.4	80	10	2000	0.25	1	51	
PZ1AL75B	1000	5	75	71.25	78.75	100	10	2000	0.25	1	56	

Zener Diodes

Part Number	P _D	V _Z	V _Z @ I _{ZT} (V)			Z _{ZT} @ I _{ZT} Max.	I _{ZT}	Z _{ZK} @ I _{ZK} Max.	I _{ZK}	I _R @ V _R Max.		Package
	mW	%	Nom.	Min.	Max.	Ω	mA	Ω	mA	μA	V	
PZ1AH3V6B	1000	5	3.6	3.42	3.78	8	100	400	1	100	1	SOD-123HE
PZ1AH3V9B	1000	5	3.9	3.71	4.1	8	100	400	1	50	1	
PZ1AH4V3B	1000	5	4.3	4.09	4.52	7	100	400	1	25	1	
PZ1AH4V7B	1000	5	4.7	4.47	4.94	7	100	400	1	10	1	
PZ1AH5V1B	1000	5	5.1	4.85	5.36	6	100	550	1	5	1	
PZ1AH5V6B	1000	5	5.6	5.32	5.88	4	100	600	1	10	2	
PZ1AH6V0B	1000	5	6	5.7	6.3	3	100	600	1	8	2	
PZ1AH6V2B	1000	5	6.2	5.89	6.51	3	100	700	1	5	2	
PZ1AH6V8B	1000	5	6.8	6.46	7.14	3	100	700	1	10	3	
PZ1AH7V5B	1000	5	7.5	7.13	7.88	2	100	700	0.5	50	3	
PZ1AH8V2B	1000	5	8.2	7.79	8.61	2	100	700	0.5	10	3	
PZ1AH8V7B	1000	5	8.7	8.27	9.14	3	50	700	0.5	10	4	
PZ1AH9V1B	1000	5	9.1	8.65	9.56	4	50	700	0.5	10	5	
PZ1AH10B	1000	5	10	9.5	10.5	4	50	700	0.25	7	7.5	
PZ1AH11B	1000	5	11	10.45	11.55	7	50	700	0.25	4	8.2	
PZ1AH12B	1000	5	12	11.4	12.6	7	50	700	0.25	3	9.1	
PZ1AH13B	1000	5	13	12.35	13.65	10	50	700	0.25	2	10	
PZ1AH14B	1000	5	14	13.3	14.7	10	50	700	0.25	2	11	
PZ1AH15B	1000	5	15	14.25	15.75	10	50	700	0.25	1	11	
PZ1AH16B	1000	5	16	15.2	16.8	15	25	700	0.25	1	12	
PZ1AH17B	1000	5	17	16.15	17.85	15	25	750	0.25	1	13	
PZ1AH18B	1000	5	18	17.1	18.9	15	25	750	0.25	1	13	
PZ1AH19B	1000	5	19	18.05	19.95	15	25	750	0.25	1	14	
PZ1AH20B	1000	5	20	19	21	15	25	750	0.25	1	15	
PZ1AH22B	1000	5	22	20.9	23.1	15	25	750	0.25	1	16	
PZ1AH24B	1000	5	24	22.8	25.2	15	25	750	0.25	1	18	
PZ1AH25B	1000	5	25	23.75	26.25	15	25	750	0.25	1	19	
PZ1AH27B	1000	5	27	25.65	28.35	15	25	750	0.25	1	20	
PZ1AH28B	1000	5	28	26.6	29.4	15	25	1000	0.25	1	21	
PZ1AH30B	1000	5	30	28.5	31.5	15	25	1000	0.25	1	22	
PZ1AH33B	1000	5	33	31.35	34.65	15	25	1000	0.25	1	24	
PZ1AH36B	1000	5	36	34.2	37.8	40	10	1000	0.25	1	27	
PZ1AH39B	1000	5	39	37.05	40.95	40	10	1000	0.25	1	30	
PZ1AH43B	1000	5	43	40.85	45.15	45	10	1500	0.25	1	33	
PZ1AH47B	1000	5	47	44.65	49.35	45	10	1500	0.25	1	36	
PZ1AH51B	1000	5	51	48.45	53.55	60	10	1500	0.25	1	39	
PZ1AH56B	1000	5	56	53.2	58.8	60	10	2000	0.25	1	43	
PZ1AH62B	1000	5	62	58.9	65.1	80	10	2000	0.25	1	47	
PZ1AH68B	1000	5	68	64.6	71.4	80	10	2000	0.25	1	51	
PZ1AH75B	1000	5	75	71.25	78.75	100	10	2000	0.25	1	56	

Zener Diodes

Part Number	P _D	V _Z	V _Z @ I _{ZT} (V)			Z _{VT} @ I _{ZT} Max.	I _{ZT}	Z _{ZK} @ I _{ZK} Max.	I _{ZK}	I _R @ V _R Max.		Package
	mW	%	Nom.	Min.	Max.	Ω	mA	Ω	mA	μA	V	
BZT52-B2V4	410	2	2.4	2.35	2.45	85	5	600	1	100	1	SOD-123
BZT52-C2V4	410	5	2.4	2.28	2.52	85	5	600	1	100	1	
BZT52-B2V7	410	2	2.7	2.64	2.75	83	5	600	1	75	1	
BZT52-C2V7	410	5	2.7	2.57	2.84	83	5	600	1	75	1	
BZT52-B3	410	2	3	2.94	3.06	95	5	600	1	50	1	
BZT52-C3	410	5	3	2.85	3.15	95	5	600	1	50	1	
BZT52-B3V3	410	2	3.3	3.23	3.37	95	5	600	1	25	1	
BZT52-C3V3	410	5	3.3	3.14	3.47	95	5	600	1	25	1	
BZT52-B3V6	410	2	3.6	3.52	3.67	95	5	600	1	15	1	
BZT52-C3V6	410	5	3.6	3.42	3.78	95	5	600	1	15	1	
BZT52-B3V9	410	2	3.9	3.82	3.98	95	5	600	1	10	1	
BZT52-C3V9	410	5	3.9	3.71	4.1	95	5	600	1	10	1	
BZT52-B4V3	410	2	4.3	4.21	4.39	95	5	600	1	5	1	
BZT52-C4V3	410	5	4.3	4.09	4.52	95	5	600	1	5	1	
BZT52-B4V7	410	2	4.7	4.61	4.79	78	5	500	1	5	1	
BZT52-C4V7	410	5	4.7	4.47	4.94	78	5	500	1	5	1	
BZT52-B5V1	410	2	5.1	5	5.2	60	5	480	1	0.1	0.8	
BZT52-C5V1	410	5	5.1	4.85	5.36	60	5	480	1	0.1	0.8	
BZT52-B5V6	410	2	5.6	5.49	5.71	40	5	400	1	0.1	1	
BZT52-C5V6	410	5	5.6	5.32	5.88	40	5	400	1	0.1	1	
BZT52-B6V2	410	2	6.2	6.08	6.32	10	5	150	1	0.1	2	
BZT52-C6V2	410	5	6.2	5.89	6.51	10	5	150	1	0.1	2	
BZT52-B6V8	410	2	6.8	6.66	6.94	8	5	80	1	0.1	3	
BZT52-C6V8	410	5	6.8	6.46	7.14	8	5	80	1	0.1	3	
BZT52-B7V5	410	2	7.5	7.35	7.65	7	5	80	1	0.1	5	
BZT52-C7V5	410	5	7.5	7.13	7.88	7	5	80	1	0.1	5	
BZT52-B8V2	410	2	8.2	8.04	8.36	7	5	80	1	0.1	6	
BZT52-C8V2	410	5	8.2	7.79	8.61	7	5	80	1	0.1	6	
BZT52-B8V7	410	2	8.7	8.53	8.87	7	5	100	1	0.1	6.5	
BZT52-C8V7	410	5	8.7	8.27	9.14	7	5	100	1	0.1	6.5	
BZT52-B9V1	410	2	9.1	8.92	9.28	10	5	100	1	0.1	7	
BZT52-C9V1	410	5	9.1	8.65	9.56	10	5	100	1	0.1	7	
BZT52-B10	410	2	10	9.8	10.2	15	5	150	1	0.1	7.5	
BZT52-C10	410	5	10	9.5	10.5	15	5	150	1	0.1	7.5	
BZT52-B11	410	2	11	10.78	11.22	20	5	150	1	0.1	8.5	
BZT52-C11	410	5	11	10.45	11.55	20	5	150	1	0.1	8.5	
BZT52-B12	410	2	12	11.76	12.24	20	5	150	1	0.1	9	
BZT52-C12	410	5	12	11.4	12.6	20	5	150	1	0.1	9	
BZT52-B13	410	2	13	12.74	13.26	25	5	170	1	0.1	10	
BZT52-C13	410	5	13	12.35	13.65	25	5	170	1	0.1	10	
BZT52-B14	410	2	14	13.72	14.28	25	5	170	1	0.1	10.5	
BZT52-C14	410	5	14	13.3	14.7	25	5	170	1	0.1	10.5	
BZT52-B15	410	2	15	14.7	15.3	30	5	200	1	0.1	11	
BZT52-C15	410	5	15	14.25	15.75	30	5	200	1	0.1	11	
BZT52-B16	410	2	16	15.68	16.32	40	5	200	1	0.1	12	
BZT52-C16	410	5	16	15.2	16.8	40	5	200	1	0.1	12	
BZT52-B17	410	2	17	16.66	17.34	40	5	200	1	0.1	13	
BZT52-C17	410	5	17	16.15	17.85	40	5	200	1	0.1	13	
BZT52-B18	410	2	18	17.64	18.36	50	5	225	1	0.1	14	
BZT52-C18	410	5	18	17.1	18.9	50	5	225	1	0.1	14	
BZT52-B20	410	2	20	19.6	20.4	50	5	225	1	0.1	15	
BZT52-C20	410	5	20	19	21	50	5	225	1	0.1	15	
BZT52-B22	410	2	22	21.56	22.44	55	5	250	1	0.1	17	
BZT52-C22	410	5	22	20.9	23.1	55	5	250	1	0.1	17	
BZT52-B24	410	2	24	23.52	24.48	80	5	250	1	0.1	18	
BZT52-C24	410	5	24	22.8	25.2	80	5	250	1	0.1	18	
BZT52-B27	410	2	27	26.46	27.54	80	5	300	1	0.1	20	
BZT52-C27	410	5	27	25.65	28.35	80	5	300	1	0.1	20	
BZT52-B28	410	2	28	27.44	28.56	80	5	300	1	0.1	22	
BZT52-C28	410	5	28	26.6	29.4	80	5	300	1	0.1	22	

Zener Diodes

Part Number	P _D	V _Z	V _Z @ I _{ZT} (V)			Z _{VT} @ I _{ZT} Max.	I _{ZT}	Z _{ZK} @ I _{ZK} Max.	I _{ZK}	I _R @ V _R Max.		Package
	mW	%	Nom.	Min.	Max.	Ω	mA	Ω	mA	μA	V	
BZT52-B30	410	2	30	29.4	30.6	80	5	300	1	0.1	22.5	SOD-123
BZT52-C30	410	5	30	28.5	31.5	80	5	300	1	0.1	22.5	
BZT52-B33	410	2	33	32.34	33.66	80	5	325	1	0.1	25	
BZT52-C33	410	5	33	31.35	34.65	80	5	325	1	0.1	25	
BZT52-B36	410	2	36	35.28	36.72	90	5	350	1	0.1	27	
BZT52-C36	410	5	36	34.2	37.8	90	5	350	1	0.1	27	
BZT52-B39	410	2	39	38.22	39.78	90	5	350	1	0.1	29	
BZT52-C39	410	5	39	37.05	40.95	90	5	350	1	0.1	29	
BZT52-B43	410	2	43	42.14	43.86	100	5	375	1	0.1	32	
BZT52-C43	410	5	43	40.85	45.15	100	5	375	1	0.1	32	
BZT52-B47	410	2	47	46.06	47.94	100	5	375	1	0.1	35	
BZT52-C47	410	5	47	44.65	49.35	100	5	375	1	0.1	35	
BZT52-B51	410	2	51	49.98	52.02	100	5	400	1	0.1	38	
BZT52-C51	410	5	51	48.45	53.55	100	5	400	1	0.1	38	
BZT52-B56	410	2	56	54.88	57.12	135	2.5	1000	1	0.1	42	
BZT52-C56	410	5	56	53.2	58.8	135	2.5	1000	1	0.1	42	
BZT52-B62	410	2	62	60.76	63.24	150	2.5	1000	1	0.1	46	
BZT52-C62	410	5	62	58.9	65.1	150	2.5	1000	1	0.1	46	
BZT52-B68	410	2	68	66.64	69.36	200	2.5	1000	1	0.1	51	
BZT52-C68	410	5	68	64.6	71.4	200	2.5	1000	1	0.1	51	
BZT52-B75	410	2	75	73.5	76.5	250	2.5	1000	1	0.1	56	
BZT52-C75	410	5	75	71.25	78.75	250	2.5	1000	1	0.1	56	
MMSZ5221B	500	5	2.4	2.28	2.52	30	20	1200	0.25	100	1	
MMSZ5222B	500	5	2.5	2.38	2.63	30	20	1250	0.25	100	1	
MMSZ5223B	500	5	2.7	2.57	2.84	30	20	1300	0.25	75	1	
MMSZ5224B	500	5	2.8	2.66	2.94	30	20	1400	0.25	75	1	
MMSZ5225B	500	5	3	2.85	3.15	30	20	1600	0.25	50	1	
MMSZ5226B	500	5	3.3	3.14	3.47	28	20	1600	0.25	25	1	
MMSZ5227B	500	5	3.6	3.42	3.78	24	20	1700	0.25	15	1	
MMSZ5228B	500	5	3.9	3.71	4.1	23	20	1900	0.25	10	1	
PZS513V9BAS	500	5	3.9	3.71	4.1	-	0.05	-	-	5	2	
MMSZ5229A	500	2	4.3	4.21	4.39	22	20	2000	0.25	5	1	
MMSZ5229B	500	5	4.3	4.09	4.52	22	20	2000	0.25	5	1	
PZS514V3BAS	500	5	4.3	4.09	4.52	-	0.05	-	-	4	2	
MMSZ5230A	500	2	4.7	4.61	4.79	19	20	1900	0.25	5	2	
MMSZ5230B	500	5	4.7	4.47	4.94	19	20	1900	0.25	5	2	
PZS514V7BAS	500	5	4.7	4.47	4.94	-	0.05	-	-	10	3	
MMSZ5231A	500	2	5.1	5	5.2	17	20	1600	0.25	5	2	
MMSZ5231B	500	5	5.1	4.85	5.36	17	20	1600	0.25	5	2	
PZS515V1BAS	500	5	5.1	4.85	5.36	-	0.05	-	-	10	3	
PZS515V3BAS	500	5	5.3	5.03	5.57	-	0.05	-	-	10	4	
MMSZ5232A	500	2	5.6	5.49	5.71	11	20	1600	0.25	5	3	
MMSZ5232B	500	5	5.6	5.32	5.88	11	20	1600	0.25	5	3	
PZS515V6BAS	500	5	5.6	5.32	5.88	-	0.05	-	-	7	4.2	
MMSZ5233B	500	5	6	5.7	6.3	7	20	1600	0.25	5	3.5	
MMSZ5234A	500	2	6.2	6.08	6.32	7	20	1000	0.25	5	4	
MMSZ5234B	500	5	6.2	5.89	6.51	7	20	1000	0.25	5	4	
PZS516V2BAS	500	5	6.2	5.89	6.51	-	0.05	-	-	10	5	
MMSZ5235A	500	2	6.8	6.66	6.94	5	20	750	0.25	3	5	
MMSZ5235B	500	5	6.8	6.46	7.14	5	20	750	0.25	3	5	
PZS516V8BAS	500	5	6.8	6.46	7.14	-	0.05	-	-	10	5.1	
MMSZ5236A	500	2	7.5	7.35	7.65	6	20	500	0.25	3	6	
MMSZ5236B	500	5	7.5	7.13	7.88	6	20	500	0.25	3	6	
PZS517V5BAS	500	5	7.5	7.13	7.88	-	0.05	-	-	10	5.7	
MMSZ5237A	500	2	8.2	8.04	8.36	8	20	500	0.25	3	6	
MMSZ5237B	500	5	8.2	7.79	8.61	8	20	500	0.25	3	6	
PZS518V2BAS	500	5	8.2	7.79	8.61	-	0.05	-	-	1	6.2	
MMSZ5238A	500	2	8.7	8.53	8.87	8	20	600	0.25	3	6.5	
MMSZ5238B	500	5	8.7	8.27	9.14	8	20	600	0.25	3	6.5	
PZS518V7BAS	500	5	8.7	8.27	9.14	-	0.05	-	-	1	6.6	

Zener Diodes

Part Number	P _D	V _Z	V _Z @ I _{ZT} (V)			Z _{VT} @ I _{ZT} Max.	I _{ZT}	Z _{ZK} @ I _{ZK} Max.	I _{ZK}	I _R @ V _R Max.		Package
	mW	%	Nom.	Min.	Max.	Ω	mA	Ω	mA	μA	V	
MMSZ5239A	500	2	9.1	8.92	9.28	10	20	600	0.25	3	6.5	SOD-123
MMSZ5239B	500	5	9.1	8.65	9.56	10	20	600	0.25	3	6.5	
PZS519V1BAS	500	5	9.1	8.65	9.56	-	0.05	-	-	1	6.9	
MMSZ5240A	500	2	10	9.8	10.2	17	20	600	0.25	3	8	
MMSZ5240B	500	5	10	9.5	10.5	17	20	600	0.25	3	8	
PZS5110BAS	500	5	10	9.5	10.5	-	0.05	-	-	1	7.6	
MMSZ5241A	500	2	11	10.78	11.22	22	20	600	0.25	2	8.4	
MMSZ5241B	500	5	11	10.45	11.55	22	20	600	0.25	2	8.4	
PZS5111BAS	500	5	11	10.5	11.6	-	0.05	-	-	0.05	8.4	
MMSZ5242A	500	2	12	11.76	12.24	30	20	600	0.25	1	9.1	
MMSZ5242B	500	5	12	11.4	12.6	30	20	600	0.25	1	9.1	
PZS5112BAS	500	5	12	11.4	12.6	-	0.05	-	-	0.05	9.1	
MMSZ5243A	500	2	13	12.74	13.26	13	9.5	600	0.25	0.5	9.9	
MMSZ5243B	500	5	13	12.35	13.65	13	9.5	600	0.25	0.5	9.9	
PZS5113BAS	500	5	13	12.4	13.7	-	0.05	-	-	0.05	9.8	
MMSZ5244A	500	2	14	13.72	14.28	15	9	600	0.25	0.1	10.5	
MMSZ5244B	500	5	14	13.3	14.7	15	9	600	0.25	0.1	10.5	
PZS5114BAS	500	5	14	13.3	14.7	-	0.05	-	-	0.05	10.6	
MMSZ5245A	500	2	15	14.7	15.3	16	8.5	600	0.25	0.1	11	
MMSZ5245B	500	5	15	14.25	15.75	16	8.5	600	0.25	0.1	11	
PZS5115BAS	500	5	15	14.3	15.8	-	0.05	-	-	0.05	11.4	
MMSZ5246A	500	2	16	15.68	16.32	17	7.8	600	0.25	0.1	12	
MMSZ5246B	500	5	16	15.2	16.8	17	7.8	600	0.25	0.1	12	
PZS5116BAS	500	5	16	15.2	16.8	-	0.05	-	-	0.05	12.1	
MMSZ5247A	500	2	17	16.66	17.34	19	7.5	600	0.25	0.1	13	
MMSZ5247B	500	5	17	16.15	17.85	19	7.5	600	0.25	0.1	13	
PZS5117BAS	500	5	17	16.2	17.9	-	0.05	-	-	0.05	12.9	
MMSZ5248A	500	2	18	17.64	18.36	21	7	600	0.25	0.1	14	
MMSZ5248B	500	5	18	17.1	18.9	21	7	600	0.25	0.1	14	
PZS5118BAS	500	5	18	17.1	18.9	-	0.05	-	-	0.05	13.6	
MMSZ5249B	500	5	19	18.05	19.95	23	6.6	600	0.25	0.1	14	
PZS5119BAS	500	5	19	18.1	20	-	0.05	-	-	0.05	14.4	
MMSZ5250A	500	2	20	19.6	20.4	25	6.2	600	0.25	0.1	15	
MMSZ5250B	500	5	20	19	21	25	6.2	600	0.25	0.1	15	
PZS5120BAS	500	5	20	19	21	-	0.05	-	-	0.01	15.2	
MMSZ5251A	500	2	22	21.56	22.44	29	5.6	600	0.25	0.1	17	
MMSZ5251B	500	5	22	20.9	23.1	29	5.6	600	0.25	0.1	17	
PZS5122BAS	500	5	22	20.9	23.1	-	0.05	-	-	0.01	16.7	
MMSZ5252A	500	2	24	23.52	24.48	33	5	600	0.25	0.1	18	
MMSZ5252B	500	5	24	22.8	25.2	33	5.2	600	0.25	0.1	18	
PZS5124BAS	500	5	24	22.8	25.2	-	0.05	-	-	0.01	18.2	
MMSZ5253B	500	5	25	23.75	26.25	35	5	600	0.25	0.1	19	
PZS5125BAS	500	5	25	23.8	26.3	-	0.05	-	-	0.01	19	
MMSZ5254A	500	2	27	26.46	27.54	41	5	600	0.25	0.1	21	
MMSZ5254B	500	5	27	25.65	28.35	41	5	600	0.25	0.1	21	
PZS5127BAS	500	5	27	25.7	28.4	-	0.05	-	-	0.01	20.4	
MMSZ5255A	500	2	28	27.44	28.56	44	4.5	600	0.25	0.1	21	
MMSZ5255B	500	5	28	26.6	29.4	44	4.5	600	0.25	0.1	21	
PZS5128BAS	500	5	28	26.6	29.4	-	0.05	-	-	0.01	21.2	
MMSZ5256A	500	2	30	29.4	30.6	49	4.2	600	0.25	0.1	23	
MMSZ5256B	500	5	30	28.5	31.5	49	4.2	600	0.25	0.1	23	
PZS5130BAS	500	5	30	28.5	31.5	-	0.05	-	-	0.01	22.8	
MMSZ5257A	500	2	33	32.34	33.66	58	3.8	700	0.25	0.1	25	
MMSZ5257B	500	5	33	31.35	34.65	58	3.8	700	0.25	0.1	25	
PZS5133BAS	500	5	33	31.4	34.7	-	0.05	-	-	0.01	25	
MMSZ5258A	500	2	36	35.28	36.72	70	3.4	700	0.25	0.1	27	
MMSZ5258B	500	5	36	34.2	37.8	70	3.4	700	0.25	0.1	27	
PZS5136BAS	500	5	36	34.2	37.8	-	0.05	-	-	0.01	27.3	
MMSZ5259A	500	2	39	38.22	39.78	80	3.2	800	0.25	0.1	30	
MMSZ5259B	500	5	39	37.05	40.95	80	3.2	800	0.25	0.1	30	

Zener Diodes

Part Number	P _D	V _Z	V _Z @ I _{ZT} (V)			Z _{VT} @ I _{ZT} Max.	I _{ZT}	Z _{ZK} @ I _{ZK} Max.	I _{ZK}	I _R @ V _R Max.		Package
	mW	%	Nom.	Min.	Max.	Ω	mA	Ω	mA	μA	V	
PZS5139BAS	500	5	39	37.1	41	-	0.05	-	-	0.01	29.6	SOD-123
MMSZ5260A	500	2	43	42.14	43.86	93	3	900	0.25	0.1	33	
MMSZ5260B	500	5	43	40.85	45.15	93	3	900	0.25	0.1	33	
PZS5143BAS	500	5	43	40.9	45.2	-	0.05	-	-	0.01	32.6	
MMSZ5261A	500	2	47	46.06	47.94	105	2.7	1000	0.25	0.1	36	
MMSZ5261B	500	5	47	44.65	49.35	105	2.7	1000	0.25	0.1	36	
MMSZ5262A	500	2	51	49.98	52.02	125	2.5	1100	0.25	0.1	39	
MMSZ5262B	500	5	51	48.45	53.55	125	2.5	1100	0.25	0.1	39	
BZX84B2V4W	200	2	2.4	2.35	2.45	100	5	600	1	50	1	
BZX84C2V4W	200	5	2.4	2.28	2.52	100	5	600	1	50	1	
MMBZ5221BW	200	5	2.4	2.28	2.52	30	20	1200	0.25	100	1	
PZD22B2V4C	200	5	2.4	2.28	2.52	100	5	600	1	50	1	
MMBZ5222BW	200	5	2.5	2.38	2.63	30	20	1250	0.25	100	1	
BZX84B2V7W	200	2	2.7	2.64	2.75	100	5	600	1	20	1	
BZX84C2V7W	200	5	2.7	2.57	2.84	100	5	600	1	20	1	
MMBZ5223BW	200	5	2.7	2.57	2.84	30	20	1300	0.25	75	1	
PZD22B2V7C	200	5	2.7	2.57	2.84	100	5	600	1	20	1	
MMBZ5224BW	200	5	2.8	2.66	2.94	30	20	1400	0.25	75	1	
BZX84B3W	200	2	3	2.94	3.06	95	5	600	1	10	1	
BZX84C3W	200	5	3	2.85	3.15	95	5	600	1	10	1	
MMBZ5225BW	200	5	3	2.85	3.15	30	20	1600	0.25	50	1	
PZD22B3V0C	200	5	3	2.85	3.15	95	5	600	1	10	1	
BZX84B3V3W	200	2	3.3	3.23	3.37	95	5	600	1	5	1	
BZX84C3V3W	200	5	3.3	3.14	3.47	95	5	600	1	5	1	
MMBZ5226BW	200	5	3.3	3.14	3.47	28	20	1600	0.25	25	1	
PZD22B3V3C	200	5	3.3	3.13	3.47	95	5	600	1	5	1	
BZX84B3V6W	200	2	3.6	3.52	3.67	90	5	600	1	5	1	
BZX84C3V6W	200	5	3.6	3.42	3.78	90	5	600	1	5	1	
MMBZ5227BW	200	5	3.6	3.42	3.78	24	20	1700	0.25	15	1	
PZD22B3V6C	200	5	3.6	3.42	3.78	90	5	600	1	5	1	
BZX84B3V9W	200	2	3.9	3.82	3.98	90	5	600	1	3	1	
BZX84C3V9W	200	5	3.9	3.71	4.1	90	5	600	1	3	1	
MMBZ5228BW	200	5	3.9	3.71	4.1	23	20	1900	0.25	10	1	
PZD22B3V9C	200	5	3.9	3.7	4.1	90	5	600	1	3	1	
BZX84B4V3W	200	2	4.3	4.21	4.39	90	5	600	1	3	1	
BZX84C4V3W	200	5	4.3	4.09	4.52	90	5	600	1	3	1	
MMBZ5229AW	200	2	4.3	4.21	4.39	22	20	2000	0.25	5	1	
MMBZ5229BW	200	5	4.3	4.09	4.52	22	20	2000	0.25	5	1	
PZD22B4V3C	200	5	4.3	4.08	4.52	88	5	600	1	3	1	
BZX84B4V7W	200	2	4.7	4.61	4.79	80	5	500	1	3	2	
BZX84C4V7W	200	5	4.7	4.47	4.94	80	5	500	1	3	2	
MMBZ5230AW	200	2	4.7	4.61	4.79	19	20	1900	0.25	5	2	
MMBZ5230BW	200	5	4.7	4.47	4.94	19	20	1900	0.25	5	2	
PZD22B4V7C	200	5	4.7	4.46	4.94	70	5	500	1	3	2	
BZX84B5V1W	200	2	5.1	5	5.2	60	5	480	1	2	2	
BZX84C5V1W	200	5	5.1	4.85	5.36	60	5	480	1	2	2	
MMBZ5231AW	200	2	5.1	5	5.2	17	20	1600	0.25	5	2	
MMBZ5231BW	200	5	5.1	4.85	5.36	17	20	1600	0.25	5	2	
PZD22B5V1C	200	5	5.1	4.84	5.36	50	5	480	1	2	2	
BZX84B5V6W	200	2	5.6	5.49	5.71	40	5	400	1	1	2	
BZX84C5V6W	200	5	5.6	5.32	5.88	40	5	400	1	1	2	
MMBZ5232AW	200	2	5.6	5.49	5.71	11	20	1600	0.25	5	3	
MMBZ5232BW	200	5	5.6	5.32	5.88	11	20	1600	0.25	5	3	
PZD22B5V6C	200	5	5.6	5.32	5.88	25	5	400	1	1	2	
MMBZ5233BW	200	5	6	5.7	6.3	7	20	1600	0.25	5	3.5	
BZX84B6V2W	200	2	6.2	6.08	6.32	10	5	150	1	3	4	
BZX84C6V2W	200	5	6.2	5.89	6.51	10	5	150	1	3	4	
MMBZ5234AW	200	2	6.2	6.08	6.32	7	20	1000	0.25	5	4	
MMBZ5234BW	200	5	6.2	5.89	6.51	7	20	1000	0.25	5	4	
PZD22B6V2C	200	5	6.2	5.89	6.51	10	5	150	1	3	4	

Zener Diodes

Part Number	P _D	V _Z	V _Z @ I _{ZT} (V)			Z _{VT} @ I _{ZT} Max.	I _{ZT}	Z _{ZK} @ I _{ZK} Max.	I _{ZK}	I _R @ V _R Max.		Package
	mW	%	Nom.	Min.	Max.	Ω	mA	Ω	mA	μA	V	
BZX84B6V8W	200	2	6.8	6.66	6.94	15	5	80	1	2	4	SOT-323
BZX84C6V8W	200	5	6.8	6.46	7.14	15	5	80	1	2	4	
MMBZ5235AW	200	2	6.8	6.66	6.94	5	20	750	0.25	3	5	
MMBZ5235BW	200	5	6.8	6.46	7.14	5	20	750	0.25	3	5	
PZD22B6V8C	200	5	6.8	6.46	7.14	8	5	80	1	2	4	
BZX84B7V5W	200	2	7.5	7.35	7.65	15	5	80	1	1	5	
BZX84C7V5W	200	5	7.5	7.13	7.88	15	5	80	1	1	5	
MMBZ5236AW	200	2	7.5	7.35	7.65	6	20	500	0.25	3	6	
MMBZ5236BW	200	5	7.5	7.13	7.88	6	20	500	0.25	3	6	
PZD22B7V5C	200	5	7.5	7.12	7.88	7	5	80	1	0.1	5	
BZX84B8V2W	200	2	8.2	8.04	8.36	15	5	80	1	0.7	5	
BZX84C8V2W	200	5	8.2	7.79	8.61	15	5	80	1	0.7	5	
MMBZ5237AW	200	2	8.2	8.04	8.36	8	20	500	0.25	3	6	
MMBZ5237BW	200	5	8.2	7.79	8.61	8	20	500	0.25	3	6	
PZD22B8V2C	200	5	8.2	7.79	8.61	7	5	80	1	0.1	6	
BZX84B8V7W	200	2	8.7	8.53	8.87	15	5	100	1	0.7	5	
BZX84C8V7W	200	5	8.7	8.27	9.14	15	5	100	1	0.7	5	
MMBZ5238AW	200	2	8.7	8.53	8.87	8	20	600	0.25	3	6.5	
MMBZ5238BW	200	5	8.7	8.27	9.14	8	20	600	0.25	3	6.5	
PZD22B8V7C	200	5	8.7	8.26	9.14	9	5	100	1	0.1	6.5	
BZX84B9V1W	200	2	9.1	8.92	9.28	15	5	100	1	0.5	6	
BZX84C9V1W	200	5	9.1	8.65	9.56	15	5	100	1	0.5	6	
MMBZ5239AW	200	2	9.1	8.92	9.28	10	20	600	0.25	3	6.5	
MMBZ5239BW	200	5	9.1	8.65	9.56	10	20	600	0.25	3	6.5	
PZD22B9V1C	200	5	9.1	8.64	9.56	10	5	100	1	0.1	7	
BZX84B10W	200	2	10	9.8	10.2	20	5	150	1	0.2	7	
BZX84C10W	200	5	10	9.5	10.5	20	5	150	1	0.2	7	
MMBZ5240AW	200	2	10	9.8	10.2	17	20	600	0.25	3	8	
MMBZ5240BW	200	5	10	9.5	10.5	17	20	600	0.25	3	8	
PZD22B10C	200	5	10	9.5	10.5	15	5	150	1	0.1	7.5	
BZX84B11W	200	2	11	10.78	11.22	20	5	150	1	0.1	8	
BZX84C11W	200	5	11	10.45	11.55	20	5	150	1	0.1	8	
MMBZ5241AW	200	2	11	10.78	11.22	22	20	600	0.25	2	8.4	
MMBZ5241BW	200	5	11	10.45	11.55	22	20	600	0.25	2	8.4	
PZD22B11C	200	5	11	10.45	11.55	18	5	150	1	0.1	8.5	
BZX84B12W	200	2	12	11.76	12.24	25	5	150	1	0.1	8	
BZX84C12W	200	5	12	11.4	12.6	25	5	150	1	0.1	8	
MMBZ5242AW	200	2	12	11.76	12.24	30	20	600	0.25	1	9.1	
MMBZ5242BW	200	5	12	11.4	12.6	30	20	600	0.25	1	9.1	
PZD22B12C	200	5	12	11.4	12.6	22	5	150	1	0.1	9	
BZX84B13W	200	2	13	12.74	13.26	30	5	170	1	0.1	8	
BZX84C13W	200	5	13	12.35	13.65	30	5	170	1	0.1	8	
MMBZ5243AW	200	2	13	12.74	13.26	13	9.5	600	0.25	0.5	9.9	
MMBZ5243BW	200	5	13	12.35	13.65	13	9.5	600	0.25	0.5	9.9	
PZD22B13C	200	5	13	12.35	13.65	25	5	170	1	0.1	10	
BZX84B14W	200	2	14	13.72	14.28	30	5	170	1	0.1	10	
BZX84C14W	200	5	14	13.3	14.7	30	5	170	1	0.1	10	
MMBZ5244AW	200	2	14	13.72	14.28	15	9	600	0.25	0.1	10.5	
MMBZ5244BW	200	5	14	13.3	14.7	15	9	600	0.25	0.1	10.5	
PZD22B14C	200	5	14	13.3	14.7	28	5	170	1	0.1	10.5	
BZX84B15W	200	2	15	14.7	15.3	30	5	200	1	0.1	10.5	
BZX84C15W	200	5	15	14.25	15.75	30	5	200	1	0.1	10.5	
MMBZ5245AW	200	2	15	14.7	15.3	16	8.5	600	0.25	0.1	11	
MMBZ5245BW	200	5	15	14.25	15.75	16	8.5	600	0.25	0.1	11	
PZD22B15C	200	5	15	14.25	15.75	32	5	200	1	0.1	11	
BZX84B16W	200	2	16	15.68	16.32	40	5	200	1	0.1	11.2	
BZX84C16W	200	5	16	15.2	16.8	40	5	200	1	0.1	11.2	
MMBZ5246AW	200	2	16	15.68	16.32	17	7.8	600	0.25	0.1	12	
MMBZ5246BW	200	5	16	15.2	16.8	17	7.8	600	0.25	0.1	12	
PZD22B16C	200	5	16	15.2	16.8	36	5	200	1	0.1	12	

Zener Diodes

Part Number	P _D	V _Z	V _Z @ I _{ZT} (V)			Z _{VT} @ I _{ZT} Max.	I _{ZT}	Z _{ZK} @ I _{ZK} Max.	I _{ZK}	I _R @ V _R Max.		Package
	mW	%	Nom.	Min.	Max.	Ω	mA	Ω	mA	μA	V	
BZX84B17W	200	2	17	16.66	17.34	40	5	200	1	0.1	12.2	SOT-323
BZX84C17W	200	5	17	16.15	17.85	40	5	200	1	0.1	12.2	
MMBZ5247AW	200	2	17	16.66	17.34	19	7.5	600	0.25	0.1	13	
MMBZ5247BW	200	5	17	16.15	17.85	19	7.5	600	0.25	0.1	13	
PZD22B17C	200	5	17	16.15	17.85	39	5	200	1	0.1	13	
BZX84B18W	200	2	18	17.64	18.36	45	5	225	1	0.1	12.6	
BZX84C18W	200	5	18	17.1	18.9	45	5	225	1	0.1	12.6	
MMBZ5248AW	200	2	18	17.64	18.36	21	7	600	0.25	0.1	14	
MMBZ5248BW	200	5	18	17.1	18.9	21	7	600	0.25	0.1	14	
PZD22B18C	200	5	18	17.1	18.9	42	5	225	1	0.1	14	
MMBZ5249BW	200	5	19	18.05	19.95	23	6.6	600	0.25	0.1	14	
BZX84B20W	200	2	20	19.6	20.4	55	5	225	1	0.1	14	
BZX84C20W	200	5	20	19	21	55	5	225	1	0.1	14	
MMBZ5250AW	200	2	20	19.6	20.4	25	6.2	600	0.25	0.1	15	
MMBZ5250BW	200	5	20	19	21	25	6.2	600	0.25	0.1	15	
PZD22B20C	200	5	20	19	21	48	5	225	1	0.1	15	
BZX84B22W	200	2	22	21.56	22.44	55	5	250	1	0.1	15.4	
BZX84C22W	200	5	22	20.9	23.1	55	5	250	1	0.1	15.4	
MMBZ5251AW	200	2	22	21.56	22.44	29	5.6	600	0.25	0.1	17	
MMBZ5251BW	200	5	22	20.9	23.1	29	5.6	600	0.25	0.1	17	
PZD22B22C	200	5	22	20.9	23.1	55	5	250	1	0.1	17	
BZX84B24W	200	2	24	23.52	24.48	70	5	250	1	0.1	16.8	
BZX84C24W	200	5	24	22.8	25.2	70	5	250	1	0.1	16.8	
MMBZ5252AW	200	2	24	23.52	24.48	33	5.2	600	0.25	0.1	18	
MMBZ5252BW	200	5	24	22.8	25.2	33	5.2	600	0.25	0.1	18	
PZD22B24C	200	5	24	22.8	25.2	62	5	250	1	0.1	18	
MMBZ5253BW	200	5	25	23.75	26.25	35	5	600	0.25	0.1	19	
BZX84B27W	200	2	27	26.46	27.54	80	5	300	1	0.05	18.9	
BZX84C27W	200	5	27	25.65	28.35	80	5	300	1	0.05	18.9	
MMBZ5254AW	200	2	27	26.46	27.54	41	5	600	0.25	0.1	21	
MMBZ5254BW	200	5	27	25.65	28.35	41	5	600	0.25	0.1	21	
PZD22B27C	200	5	27	25.65	28.35	70	5	300	1	0.1	20	
BZX84B28W	200	2	28	27.44	28.56	80	5	300	1	0.05	20.5	
BZX84C28W	200	5	28	26.6	29.4	80	5	300	1	0.05	20.5	
MMBZ5255AW	200	2	28	27.44	28.56	44	4.5	600	0.25	0.1	21	
MMBZ5255BW	200	5	28	26.6	29.4	44	4.5	600	0.25	0.1	21	
PZD22B28C	200	5	28	26.6	29.4	74	5	300	1	0.1	22	
BZX84B30W	200	2	30	29.4	30.6	80	5	300	1	0.05	21	
BZX84C30W	200	5	30	28.5	31.5	80	5	300	1	0.05	21	
MMBZ5256AW	200	2	30	29.4	30.6	49	4.2	600	0.25	0.1	23	
MMBZ5256BW	200	5	30	28.5	31.5	49	4.2	600	0.25	0.1	23	
PZD22B30C	200	5	30	28.5	31.5	78	5	300	1	0.1	22.5	
BZX84B33W	200	2	33	32.34	33.66	80	5	325	1	0.05	23.1	
BZX84C33W	200	5	33	31.35	34.65	80	5	325	1	0.05	23.1	
MMBZ5257AW	200	2	33	32.34	33.66	58	3.8	700	0.25	0.1	25	
MMBZ5257BW	200	5	33	31.35	34.65	58	3.8	700	0.25	0.1	25	
PZD22B33C	200	5	33	31.35	34.65	88	5	325	1	0.1	25	
BZX84B36W	200	2	36	35.28	36.72	90	5	350	1	0.05	25.2	
BZX84C36W	200	5	36	34.2	37.8	90	5	350	1	0.05	25.2	
MMBZ5258AW	200	2	36	35.28	36.72	70	3.4	700	0.25	0.1	27	
MMBZ5258BW	200	5	36	34.2	37.8	70	3.4	700	0.25	0.1	27	
PZD22B36C	200	5	36	34.2	37.8	95	5	350	1	0.1	27	
BZX84B39W	200	2	39	38.22	39.78	130	5	350	1	0.05	27.3	
BZX84C39W	200	5	39	37.05	40.95	130	5	350	1	0.05	27.3	
MMBZ5259AW	200	2	39	38.22	39.78	80	3.2	800	0.25	0.1	30	
MMBZ5259BW	200	5	39	37.05	40.95	80	3.2	800	0.25	0.1	30	
PZD22B39C	200	5	39	37.05	40.95	130	5	350	1	0.1	29	
BZX84B43W	200	2	43	42.14	43.86	150	5	375	1	0.1	30.1	
BZX84C43W	200	5	43	40.85	45.15	150	5	375	1	0.05	30.1	
MMBZ5260AW	200	2	43	42.14	43.86	93	3	900	0.25	0.1	33	

Zener Diodes

Part Number	P_D	V_Z	$V_Z @ I_{ZT}$			$Z_{ZT} @ I_{ZT}$	I_{ZT}	$Z_{ZK} @ I_{ZK}$	I_{ZK}	$I_R @ V_R$		Package
	mW	%	Nom.	Min.	Max.	Ω	mA	Ω	mA	μA	V	
MMBZ5260BW	200	5	43	40.85	45.15	93	3	900	0.25	0.1	33	SOT-323
PZD22B43C	200	5	43	40.85	45.15	150	5	375	1	0.1	32	
BZX84B47W	200	2	47	46.06	47.94	170	5	375	1	0.1	32.9	
BZX84C47W	200	5	47	44.65	49.35	170	5	375	1	0.05	32.9	
MMBZ5261AW	200	2	47	46.06	47.94	105	2.7	1000	0.25	0.1	36	
MMBZ5261BW	200	5	47	44.65	49.35	105	2.7	1000	0.25	0.1	36	
PZD22B47C	200	5	47	44.65	49.35	170	5	375	1	0.1	35	
BZX84B51W	200	2	51	49.98	52.02	100	5	400	1	0.1	38	
BZX84C51W	200	5	51	48.45	53.55	100	5	400	1	0.1	38	
MMBZ5262AW	200	2	51	49.98	52.02	125	2.5	1100	0.25	0.1	39	
MMBZ5262BW	200	5	51	48.45	53.55	125	2.5	1100	0.25	0.1	39	
PZD22B51C	200	5	51	48.45	53.55	180	5	400	1	0.1	38	
BZX84B56W	200	2	56	54.88	57.12	135	2.5	1000	1	0.05	42	
BZX84C56W	200	5	56	53.2	58.8	135	2.5	1000	1	0.1	42	
PZD22B56C	200	5	56	53.2	58.8	200	2.5	1000	1	0.1	42	
BZX84B62W	200	2	62	60.76	63.24	150	2.5	1000	1	0.1	46	
BZX84C62W	200	5	62	58.9	65.1	150	2.5	1000	1	0.1	46	
PZD22B62C	200	5	62	58.9	65.1	225	2.5	1000	1	0.1	46	
BZX84B68W	200	2	68	66.64	69.36	200	2.5	1000	1	0.1	51	
BZX84C68W	200	5	68	64.6	71.4	200	2.5	1000	1	0.1	51	
PZD22B68C	200	5	68	64.6	71.4	240	2.5	1000	1	0.1	51	
BZX84B75W	200	2	75	73.5	76.5	250	2.5	1000	1	0.1	56	
BZX84C75W	200	5	75	71.25	78.75	250	2.5	1000	1	0.1	56	
PZD22B75C	200	5	75	71.25	78.75	265	2.5	1000	1	0.1	56	

Zener Diodes

Part Number	P _D	V _Z	V _Z @ I _{ZT} (V)			Z _{ZT} @ I _{ZT} Max.	I _{ZT}	Z _{ZK} @ I _{ZK} Max.	I _{ZK}	I _R @ V _R Max.		Package
	mW	%	Nom.	Min.	Max.	Ω	mA	Ω	mA	μA	V	
BZX84C2V4TW	200	5	2.4	2.28	2.52	100	5	600	1	50	1	SOT-363
MMBZ5221BTW	200	5	2.4	2.28	2.52	30	20	1200	0.25	100	1	
MMBZ5222BTW	200	5	2.5	2.375	2.625	30	20	1250	0.25	100	1	
BZX84C2V7TW	200	5	2.7	2.565	2.835	100	5	600	1	20	1	
MMBZ5223BTW	200	5	2.7	2.565	2.835	30	20	1300	0.25	75	1	
MMBZ5224BTW	200	5	2.8	2.66	2.94	30	20	1400	0.25	75	1	
BZX84C3V0TW	200	5	3	2.85	3.15	95	5	600	1	10	1	
MMBZ5225BTW	200	5	3	2.85	3.15	30	20	1600	0.25	50	1	
BZX84C3V3TW	200	5	3.3	3.135	3.465	95	5	600	1	5	1	
MMBZ5226BTW	200	5	3.3	3.135	3.465	28	20	1600	0.25	25	1	
BZX84C3V6TW	200	5	3.6	3.42	3.78	90	5	600	1	5	1	
MMBZ5227BTW	200	5	3.6	3.42	3.78	24	20	1700	0.25	15	1	
BZX84C3V9TW	200	5	3.9	3.705	4.095	90	5	600	1	3	1	
MMBZ5228BTW	200	5	3.9	3.705	4.095	23	20	1900	0.25	10	1	
BZX84C4V3TW	200	5	4.3	4.085	4.515	90	5	600	1	3	1	
MMBZ5229BTW	200	5	4.3	4.085	4.515	22	20	2000	0.25	5	1	
BZX84C4V7TW	200	5	4.7	4.465	4.935	80	5	500	1	3	2	
MMBZ5230BTW	200	5	4.7	4.465	4.935	19	20	1900	0.25	5	2	
BZX84C5V1TW	200	5	5.1	4.845	5.355	60	5	480	1	2	2	
MMBZ5231BTW	200	5	5.1	4.845	5.355	17	20	1600	0.25	5	2	
BZX84C5V6TW	200	5	5.6	5.32	5.88	40	5	400	1	1	2	
MMBZ5232BTW	200	5	5.6	5.32	5.88	11	20	1600	0.25	5	3	
MMBZ5233BTW	200	5	6	5.7	6.3	7	20	1600	0.25	5	3.5	
BZX84C6V2TW	200	5	6.2	5.89	6.51	10	5	150	1	3	4	
MMBZ5234BTW	200	5	6.2	5.89	6.51	7	20	1000	0.25	5	4	
BZX84C6V8TW	200	5	6.8	6.46	7.14	15	5	80	1	2	4	
MMBZ5235BTW	200	5	6.8	6.46	7.14	5	20	750	0.25	3	5	
BZX84C7V5TW	200	5	7.5	7.125	7.875	15	5	80	1	1	5	
MMBZ5236BTW	200	5	7.5	7.125	7.875	6	20	500	0.25	3	6	
BZX84C8V2TW	200	5	8.2	7.79	8.61	15	5	80	1	0.7	5	
MMBZ5237BTW	200	5	8.2	7.79	8.61	8	20	500	0.25	3	6.5	
BZX84C8V7TW	200	5	8.7	8.265	9.135	15	5	100	1	0.7	5	
MMBZ5238BTW	200	5	8.7	8.265	9.135	8	20	600	0.25	3	6.5	
BZX84C9V1TW	200	5	9.1	8.645	9.555	15	5	100	1	0.5	6	
MMBZ5239BTW	200	5	9.1	8.645	9.555	10	20	600	0.25	3	7	
BZX84C10TW	200	5	10	9.5	10.5	20	5	150	1	0.2	7	
MMBZ5240BTW	200	5	10	9.5	10.5	17	20	600	0.25	3	8	
BZX84C11TW	200	5	11	10.45	11.55	20	5	150	1	0.1	8	
MMBZ5241BTW	200	5	11	10.45	11.55	22	20	600	0.25	2	8.4	
BZX84C12TW	200	5	12	11.4	12.6	25	5	150	1	0.1	8	
MMBZ5242BTW	200	5	12	11.4	12.6	30	20	600	0.25	1	9.1	

Zener Diodes

Part Number	P _D	V _Z	V _Z @ I _{ZT} (V)			Z _{ZT} @ I _{ZT} Max.	I _{ZT}	Z _{ZK} @ I _{ZK} Max.	I _{ZK}	I _R @ V _R Max.		Package
	mW	%	Nom.	Min.	Max.	Ω	mA	Ω	mA	μA	V	
BZX84C13TW	200	5	13	12.35	13.65	30	5	170	1	0.1	8	SOT-363
MMBZ5243BTW	200	5	13	12.35	13.65	13	9.5	600	0.25	0.5	9.9	
BZX84C14TW	200	5	14	13.3	14.7	30	5	170	1	0.05	10	
MMBZ5244BTW	200	5	14	13.3	14.7	15	9	600	0.25	0.1	10.5	
BZX84C15TW	200	5	15	14.25	15.75	30	5	200	1	0.05	10.5	
MMBZ5245BTW	200	5	15	14.25	15.75	16	8.5	600	0.25	0.1	11	
BZX84C16TW	200	5	16	15.2	16.8	40	5	200	1	0.05	11.2	
MMBZ5246BTW	200	5	16	15.2	16.8	17	7.8	600	0.25	0.1	12	
BZX84C17TW	200	5	17	16.15	17.85	40	5	200	1	0.05	12.2	
MMBZ5247BTW	200	5	17	16.15	17.85	19	7.5	600	0.25	0.1	13	
BZX84C18TW	200	5	18	17.1	18.9	45	5	225	1	0.05	12.6	
MMBZ5248BTW	200	5	18	17.1	18.9	21	7	600	0.25	0.1	14	
MMBZ5249BTW	200	5	19	18.05	19.95	23	6.6	600	0.25	0.1	14	
BZX84C20TW	200	5	20	19	21	55	5	225	1	0.05	14	
MMBZ5250BTW	200	5	20	19	21	25	6.2	600	0.25	0.1	15	
BZX84C22TW	200	5	22	20.9	23.1	55	5	250	1	0.05	15.4	
MMBZ5251BTW	200	5	22	20.9	23.1	29	5.6	600	0.25	0.1	17	
BZX84C24TW	200	5	24	22.8	25.2	70	5	250	1	0.05	16.8	
MMBZ5252BTW	200	5	24	22.8	25.2	33	5.2	600	0.25	0.1	18	
MMBZ5253BTW	200	5	25	23.75	26.25	35	5	600	0.25	0.1	19	
BZX84C27TW	200	5	27	25.65	28.35	80	5	300	1	0.05	18.9	
MMBZ5254BTW	200	5	27	25.65	28.35	41	5	600	0.25	0.1	21	
BZX84C28TW	200	5	28	26.6	29.4	80	5	300	1	0.05	20.5	
MMBZ5255BTW	200	5	28	26.6	29.4	44	4.5	600	0.25	0.1	21	
BZX84C30TW	200	5	30	28.5	31.5	80	5	300	1	0.05	21	
MMBZ5256BTW	200	5	30	28.5	31.5	49	4.2	600	0.25	0.1	23	
BZX84C33TW	200	5	33	31.35	34.65	80	5	325	1	0.05	23.1	
MMBZ5257BTW	200	5	33	31.35	34.65	58	3.8	700	0.25	0.1	25	
BZX84C36TW	200	5	36	34.2	37.8	90	5	350	1	0.05	25.2	
MMBZ5258BTW	200	5	36	34.2	37.8	70	3.4	700	0.25	0.1	27	
BZX84C39TW	200	5	39	37.05	40.95	130	5	350	1	0.05	27.3	
MMBZ5259BTW	200	5	39	37.05	40.95	80	3.2	800	0.25	0.1	30	
BZX84C43TW	200	5	43	40.85	45.15	150	5	375	1	0.05	30.1	
MMBZ5260BTW	200	5	43	40.85	45.15	93	3	900	0.25	0.1	33	
BZX84C47TW	200	5	47	44.65	49.35	170	5	375	1	0.05	32.9	
MMBZ5261BTW	200	5	47	44.65	49.35	105	2.7	1000	0.25	0.1	36	
BZX84C51TW	200	5	51	48.45	53.55	100	5	400	1	0.05	38	
MMBZ5262BTW	200	5	51	48.45	53.55	125	2.5	1100	0.25	0.1	39	
BZX84C56TW	200	5	56	53.2	58.8	135	2.5	1000	1	0.05	42	
BZX84C62TW	200	5	62	58.9	65.1	150	2.5	1000	1	0.05	46	
BZX84C68TW	200	5	68	64.6	71.4	200	2.5	1000	1	0.05	51	
BZX84C75TW	200	5	75	71.25	78.75	250	2.5	1000	1	0.05	56	

Zener Diodes

Part Number	P _D	V _Z	V _Z @ I _{ZT} (V)			Z _{VT} @ I _{ZT} Max.	I _{ZT}	Z _{ZK} @ I _{ZK} Max.	I _{ZK}	I _R @ V _R Max.		Package
	mW	%	Nom.	Min.	Max.	Ω	mA	Ω	mA	μA	V	
ST223C5V6	200	5	5.6	5.31	5.92	60	5	200	0.5	1	2.5	SOT-23
AZ23C5V6P	200	5	5.62	5.31	5.92	60	5	200	0.5	1	2.5	
AZ23C2V4	300	5	2.4	2.28	2.52	85	5	600	1	100	1	
DZ23C2V4	300	5	2.4	2.28	2.52	85	5	600	1	100	1	
AZ23C2V7	300	5	2.7	2.57	2.84	83	5	600	1	75	1	
DZ23C2V7	300	5	2.7	2.57	2.84	83	5	600	1	75	1	
AZ23C3V0	300	5	3	2.85	3.15	95	5	600	1	50	1	
DZ23C3V0	300	5	3	2.85	3.15	95	5	600	1	50	1	
AZ23C3V3	300	5	3.3	3.14	3.47	95	5	600	1	25	1	
DZ23C3V3	300	5	3.3	3.14	3.47	95	5	600	1	25	1	
AZ23C3V6	300	5	3.6	3.42	3.78	95	5	600	1	15	1	
DZ23C3V6	300	5	3.6	3.42	3.78	90	5	600	1	5	1	
AZ23C3V9	300	5	3.9	3.71	4.1	95	5	600	1	10	1	
DZ23C3V9	300	5	3.9	3.71	4.1	90	5	600	1	3	1	
AZ23C4V3	300	5	4.3	4.09	4.52	95	5	600	1	5	1	
DZ23C4V3	300	5	4.3	4.09	4.52	95	5	600	1	5	1	
AZ23C4V7	300	5	4.7	4.47	4.94	78	5	500	1	5	1	
DZ23C4V7	300	5	4.7	4.47	4.94	78	5	500	1	5	2	
AZ23C5V1	300	5	5.1	4.85	5.36	60	5	480	1	0.1	0.8	
DZ23C5V1	300	5	5.1	4.85	5.36	60	5	480	1	0.1	0.8	
AZ23C5V6	300	5	5.6	5.32	5.88	40	5	400	1	0.1	1	
DZ23C5V6	300	5	5.6	5.32	5.88	40	5	400	1	0.1	1	
AZ23C6V2	300	5	6.2	5.89	6.51	10	5	150	1	0.1	2	
DZ23C6V2	300	5	6.2	5.89	6.51	10	5	150	1	0.1	2	
AZ23C6V8	300	5	6.8	6.46	7.14	8	5	80	1	0.1	3	
DZ23C6V8	300	5	6.8	6.46	7.14	8	5	80	1	0.1	3	
AZ23C7V5	300	5	7.5	7.13	7.88	7	5	80	1	0.1	5	
DZ23C7V5	300	5	7.5	7.13	7.88	7	5	80	1	0.1	5	
AZ23C8V2	300	5	8.2	7.79	8.61	7	5	80	1	0.1	6	
DZ23C8V2	300	5	8.2	7.79	8.61	7	5	80	1	0.1	6	
AZ23C8V7	300	5	8.7	8.27	9.14	7	5	100	1	0.1	6.5	
DZ23C8V7	300	5	8.7	8.27	9.14	7	5	80	1	0.1	6.5	
AZ23C9V1	300	5	9.1	8.65	9.56	10	5	100	1	0.1	7	
DZ23C9V1	300	5	9.1	8.65	9.56	10	5	100	1	0.1	7	
AZ23C10	300	5	10	9.5	10.5	15	5	150	1	0.1	7.5	
DZ23C10	300	5	10	9.5	10.5	15	5	150	1	0.1	7.5	
AZ23C11	300	5	11	10.45	11.55	20	5	150	1	0.1	8.5	
DZ23C11	300	5	11	10.45	11.55	20	5	150	1	0.1	8.5	
AZ23C12	300	5	12	11.4	12.6	20	5	150	1	0.1	9	
DZ23C12	300	5	12	11.4	12.6	20	5	150	1	0.1	9	
AZ23C13	300	5	13	12.35	13.65	25	5	170	1	0.1	10	
DZ23C13	300	5	13	12.35	13.65	25	5	170	1	0.1	10	
AZ23C14	300	5	14	13.3	14.7	25	5	170	1	0.1	10.5	
DZ23C14	300	5	14	13.3	14.7	25	5	170	1	0.1	10.5	
AZ23C15	300	5	15	14.25	15.75	30	5	200	1	0.1	11	
DZ23C15	300	5	15	14.25	15.75	30	5	200	1	0.1	11	
AZ23C16	300	5	16	15.2	16.8	40	5	200	1	0.1	12	
DZ23C16	300	5	16	15.2	16.8	40	5	200	1	0.1	12	
AZ23C17	300	5	17	16.15	17.85	40	5	200	1	0.1	13	
DZ23C17	300	5	17	16.15	17.85	40	5	200	1	0.1	13	
AZ23C18	300	5	18	17.1	18.9	50	5	225	1	0.1	14	
DZ23C18	300	5	18	17.1	18.9	50	5	225	1	0.1	14	
AZ23C20	300	5	20	19	21	50	5	225	1	0.1	15	
DZ23C20	300	5	20	19	21	50	5	225	1	0.1	15	
AZ23C22	300	5	22	20.9	23.1	55	5	250	1	0.1	17	
DZ23C22	300	5	22	20.9	23.1	55	5	250	1	0.1	17	
AZ23C24	300	5	24	22.8	25.2	80	5	250	1	0.1	18	
DZ23C24	300	5	24	22.8	25.2	80	5	250	1	0.1	18	
AZ23C27	300	5	27	25.65	28.35	80	5	300	1	0.1	20	
DZ23C27	300	5	27	25.65	28.35	80	5	300	1	0.1	20	

Zener Diodes

Part Number	P _D	V _Z	V _Z @ I _{ZT} (V)			Z _{VT} @ I _{ZT} Max.	I _{ZT}	Z _{ZK} @ I _{ZK} Max.	I _{ZK}	I _R @ V _R Max.		Package
	mW	%	Nom.	Min.	Max.	Ω	mA	Ω	mA	μA	V	
AZ23C28	300	5	28	26.6	29.4	80	5	300	1	0.1	22	SOT-23
DZ23C28	300	5	28	26.6	29.4	80	5	300	1	0.1	22	
AZ23C30	300	5	30	28.5	31.5	80	5	300	1	0.1	22.5	
DZ23C30	300	5	30	28.5	31.5	80	5	300	1	0.1	22.5	
AZ23C33	300	5	33	31.35	34.65	80	5	325	1	0.1	25	
DZ23C33	300	5	33	31.35	34.65	80	5	325	1	0.1	25	
AZ23C36	300	5	36	34.2	37.8	90	5	350	1	0.1	27	
DZ23C36	300	5	36	34.2	37.8	90	5	350	1	0.1	27	
AZ23C39	300	5	39	37.05	40.95	90	5	350	1	0.1	29	
DZ23C39	300	5	39	37.05	40.95	90	5	350	1	0.1	29	
AZ23C43	300	5	43	40.85	45.15	100	5	375	1	0.1	32	
DZ23C43	300	5	43	40.85	45.15	100	5	375	1	0.1	32	
AZ23C47	300	5	47	44.65	49.35	100	5	375	1	0.1	35	
DZ23C47	300	5	47	44.65	49.35	100	5	375	1	0.1	35	
AZ23C51	300	5	51	48.45	53.55	100	5	400	1	0.1	38	
DZ23C51	300	5	51	48.45	53.55	100	5	400	1	0.1	38	
BZX84B2V4	410	2	2.4	2.35	2.45	100	5	600	1	50	1	
BZX84C2V4	410	5	2.4	2.28	2.52	100	5	600	1	50	1	
MMBZ5221B	410	5	2.4	2.28	2.52	30	20	1200	0.25	100	1	
MMBZ5222B	410	5	2.5	2.38	2.63	30	20	1250	0.25	100	1	
BZX84B2V7	410	2	2.7	2.64	2.75	100	5	600	1	20	1	
BZX84C2V7	410	5	2.7	2.57	2.84	100	5	600	1	20	1	
MMBZ5223B	410	5	2.7	2.57	2.84	30	20	1300	0.25	75	1	
MMBZ5224B	410	5	2.8	2.66	2.94	30	20	1400	0.25	75	1	
BZX84B3	410	2	3	2.94	3.06	95	5	600	1	10	1	
BZX84C3	410	5	3	2.85	3.15	95	5	600	1	10	1	
MMBZ5225B	410	5	3	2.85	3.15	30	20	1600	0.25	50	1	
BZX84B3V3	410	2	3.3	3.23	3.37	95	5	600	1	5	1	
BZX84C3V3	410	5	3.3	3.14	3.47	95	5	600	1	5	1	
MMBZ5226B	410	5	3.3	3.14	3.47	28	20	1600	0.25	25	1	
BZX84B3V6	410	2	3.6	3.52	3.67	90	5	600	1	5	1	
BZX84C3V6	410	5	3.6	3.42	3.78	90	5	600	1	5	1	
MMBZ5227B	410	5	3.6	3.42	3.78	24	20	1700	0.25	15	1	
BZX84B3V9	410	2	3.9	3.82	3.98	90	5	600	1	3	1	
BZX84C3V9	410	5	3.9	3.71	4.1	90	5	600	1	3	1	
MMBZ5228B	410	5	3.9	3.71	4.1	23	20	1900	0.25	10	1	
BZX84B4V3	410	2	4.3	4.21	4.39	90	5	600	1	3	1	
BZX84C4V3	410	5	4.3	4.09	4.52	90	5	600	1	3	1	
MMBZ5229A	410	2	4.3	4.21	4.39	22	20	2000	0.25	5	1	
MMBZ5229B	410	5	4.3	4.09	4.52	22	20	2000	0.25	5	1	
BZX84A4V7	410	2	4.7	4.65	4.75	80	5	500	1	3	2	
BZX84B4V7	410	2	4.7	4.61	4.79	80	5	500	1	3	2	
BZX84C4V7	410	5	4.7	4.47	4.94	80	5	500	1	3	2	
MMBZ5230A	410	2	4.7	4.61	4.79	19	20	1900	0.25	5	2	
MMBZ5230B	410	5	4.7	4.47	4.94	19	20	1900	0.25	5	2	
BZX84B5V1	410	2	5.1	5	5.2	60	5	480	1	2	2	
BZX84C5V1	410	5	5.1	4.85	5.36	60	5	480	1	2	2	
MMBZ5231A	410	2	5.1	5	5.2	17	20	1600	0.25	5	2	
MMBZ5231B	410	5	5.1	4.85	5.36	17	20	1600	0.25	5	2	
BZX84B5V6	410	2	5.6	5.49	5.71	40	5	400	1	1	2	
BZX84C5V6	410	5	5.6	5.32	5.88	40	5	400	1	1	2	
MMBZ5232A	410	2	5.6	5.49	5.71	11	20	1600	0.25	5	3	
MMBZ5232B	410	5	5.6	5.32	5.88	11	20	1600	0.25	5	3	
MMBZ5233A	410	2	6	5.88	6.12	7	20	1600	0.25	5	3.5	
MMBZ5233B	410	5	6	5.7	6.3	7	20	1600	0.25	5	3.5	
BZX84B6V2	410	2	6.2	6.08	6.32	10	5	150	1	3	4	
BZX84C6V2	410	5	6.2	5.89	6.51	10	5	150	1	3	4	
MMBZ5234A	410	2	6.2	6.08	6.32	7	20	1000	0.25	5	4	
MMBZ5234B	410	5	6.2	5.89	6.51	7	20	1000	0.25	5	4	
BZX84B6V8	410	2	6.8	6.66	6.94	15	5	80	1	2	4	

Zener Diodes

Part Number	P _D	V _Z	V _Z @ I _{ZT} (V)			Z _{VT} @ I _{ZT} Max.	I _{ZT}	Z _{ZK} @ I _{ZK} Max.	I _{ZK}	I _R @ V _R Max.		Package
	mW	%	Nom.	Min.	Max.	Ω	mA	Ω	mA	μA	V	
BZX84C6V8	410	5	6.8	6.46	7.14	15	5	80	1	2	4	SOT-23
MMBZ5235A	410	2	6.8	6.66	6.94	5	20	750	0.25	3	5	
MMBZ5235B	410	5	6.8	6.46	7.14	5	20	750	0.25	3	5	
BZX84B7V5	410	2	7.5	7.35	7.65	15	5	80	1	1	5	
BZX84C7V5	410	5	7.5	7.13	7.88	15	5	80	1	1	5	
MMBZ5236A	410	2	7.5	7.35	7.65	6	20	500	0.25	3	6	
MMBZ5236B	410	5	7.5	7.13	7.88	6	20	500	0.25	3	6	
BZX84B8V2	410	2	8.2	8.04	8.36	15	5	80	1	0.7	5	
BZX84C8V2	410	5	8.2	7.79	8.61	15	5	80	1	0.7	5	
MMBZ5237A	410	2	8.2	8.04	8.36	8	20	500	0.25	3	6	
MMBZ5237B	410	5	8.2	7.79	8.61	8	20	500	0.25	3	6	
BZX84B8V7	410	2	8.7	8.53	8.87	15	5	100	1	0.7	5	
BZX84C8V7	410	5	8.7	8.27	9.14	15	5	100	1	0.7	5	
MMBZ5238A	410	2	8.7	8.53	8.87	8	20	600	0.25	3	6.5	
MMBZ5238B	410	5	8.7	8.27	9.14	8	20	600	0.25	3	6.5	
BZX84B9V1	410	2	9.1	8.92	9.28	15	5	100	1	0.5	6	
BZX84C9V1	410	5	9.1	8.65	9.56	15	5	100	1	0.5	6	
MMBZ5239A	410	2	9.1	8.92	9.28	10	20	600	0.25	3	6.5	
MMBZ5239B	410	5	9.1	8.65	9.56	10	20	600	0.25	3	6.5	
BZX84B10	410	2	10	9.8	10.2	20	5	150	1	0.2	7	
BZX84C10	410	5	10	9.5	10.5	20	5	150	1	0.2	7	
MMBZ5240A	410	2	10	9.8	10.2	17	20	600	0.25	3	8	
MMBZ5240B	410	5	10	9.5	10.5	17	20	600	0.25	3	8	
BZX84B11	410	2	11	10.78	11.22	20	5	150	1	0.1	8	
BZX84C11	410	5	11	10.45	11.55	20	5	150	1	0.1	8	
MMBZ5241A	410	2	11	10.78	11.22	22	20	600	0.25	2	8.4	
MMBZ5241B	410	5	11	10.45	11.55	22	20	600	0.25	2	8.4	
BZX84B12	410	2	12	11.76	12.24	25	5	150	1	0.1	8	
BZX84C12	410	5	12	11.4	12.6	25	5	150	1	0.1	8	
MMBZ5242A	410	2	12	11.76	12.24	30	20	600	0.25	1	9.1	
MMBZ5242B	410	5	12	11.4	12.6	30	20	600	0.25	1	9.1	
BZX84B13	410	2	13	12.74	13.26	30	5	170	1	0.1	8	
BZX84C13	410	5	13	12.35	13.65	30	5	170	1	0.1	8	
MMBZ5243A	410	2	13	12.74	13.26	13	9.5	600	0.25	0.5	9.9	
MMBZ5243B	410	5	13	12.35	13.65	13	9.5	600	0.25	0.5	9.9	
BZX84B14	410	2	14	13.72	14.28	30	5	170	1	0.1	10	
BZX84C14	410	5	14	13.3	14.7	30	5	170	1	0.1	10	
MMBZ5244A	410	2	14	13.72	14.28	15	9	600	0.25	0.1	10.5	
MMBZ5244B	410	5	14	13.3	14.7	15	9	600	0.25	0.1	10.5	
BZX84B15	410	2	15	14.7	15.3	30	5	200	1	0.1	10.5	
BZX84C15	410	5	15	14.25	15.75	30	5	200	1	0.1	10.5	
MMBZ5245A	410	2	15	14.7	15.3	16	8.5	600	0.25	0.1	11	
MMBZ5245B	410	5	15	14.25	15.75	16	8.5	600	0.25	0.1	11	
BZX84B16	410	2	16	15.68	16.32	40	5	200	1	0.1	11.2	
BZX84C16	410	5	16	15.2	16.8	40	5	200	1	0.1	11.2	
MMBZ5246A	410	2	16	15.68	16.32	17	7.8	600	0.25	0.1	12	
MMBZ5246B	410	5	16	15.2	16.8	17	7.8	600	0.25	0.1	12	
BZX84B17	410	2	17	16.66	17.34	40	5	200	1	0.1	12.2	
BZX84C17	410	5	17	16.15	17.85	40	5	200	1	0.1	12.2	
MMBZ5247A	410	2	17	16.66	17.34	19	7.5	600	0.25	0.1	13	
MMBZ5247B	410	5	17	16.15	17.85	19	7.5	600	0.25	0.1	13	
BZX84B18	410	2	18	17.64	18.36	45	5	225	1	0.1	12.6	
BZX84C18	410	5	18	17.1	18.9	45	5	225	1	0.1	12.6	
MMBZ5248A	410	2	18	17.64	18.36	21	7	600	0.25	0.1	14	
MMBZ5248B	410	5	18	17.1	18.9	21	7	600	0.25	0.1	14	
MMBZ5249A	410	2	19	18.62	19.38	23	6.6	600	0.25	0.1	14	
MMBZ5249B	410	5	19	18.05	19.95	23	6.6	600	0.25	0.1	14	
BZX84B20	410	2	20	19.6	20.4	55	5	225	1	0.1	14	
BZX84C20	410	5	20	19	21	55	5	225	1	0.1	14	
MMBZ5250A	410	2	20	19.6	20.4	25	6.2	600	0.25	0.1	15	

Zener Diodes

Part Number	P _D	V _Z	V _Z @ I _{ZT} (V)			Z _{VT} @ I _{ZT} Max.	I _{ZT}	Z _{ZK} @ I _{ZK} Max.	I _{ZK}	I _R @ V _R Max.		Package
	mW	%	Nom.	Min.	Max.	Ω	mA	Ω	mA	μA	V	
MMBZ5250B	410	5	20	19	21	25	6.2	600	0.25	0.1	15	SOT-23
BZX84B22	410	2	22	21.56	22.44	55	5	250	1	0.1	15.4	
BZX84C22	410	5	22	20.9	23.1	55	5	250	1	0.1	15.4	
MMBZ5251A	410	2	22	21.56	22.44	29	5.6	600	0.25	0.1	17	
MMBZ5251B	410	5	22	20.9	23.1	29	5.6	600	0.25	0.1	17	
BZX84B24	410	2	24	23.52	24.48	70	5	250	1	0.1	16.8	
BZX84C24	410	5	24	22.8	25.2	70	5	250	1	0.1	16.8	
MMBZ5252A	410	2	24	23.52	24.48	33	5.2	600	0.25	0.1	18	
MMBZ5252B	410	5	24	22.8	25.2	33	5.2	600	0.25	0.1	18	
MMBZ5253A	410	2	25	24.5	25.5	35	5	600	0.25	0.1	19	
MMBZ5253B	410	5	25	23.75	26.25	35	5	600	0.25	0.1	19	
BZX84B27	410	2	27	26.46	27.54	80	5	300	1	0.05	18.9	
BZX84C27	410	5	27	25.65	28.35	80	5	300	1	0.05	18.9	
MMBZ5254A	410	2	27	26.46	27.54	41	5	600	0.25	0.1	21	
MMBZ5254B	410	5	27	25.65	28.35	41	5	600	0.25	0.1	21	
BZX84B28	410	2	28	27.44	28.56	80	5	300	1	0.05	20.5	
BZX84C28	410	5	28	26.6	29.4	80	5	300	1	0.05	20.5	
MMBZ5255A	410	2	28	27.44	28.56	44	4.5	600	0.25	0.1	21	
MMBZ5255B	410	5	28	26.6	29.4	44	4.5	600	0.25	0.1	21	
BZX84B30	410	2	30	29.4	30.6	80	5	300	1	0.05	21	
BZX84C30	410	5	30	28.5	31.5	80	5	300	1	0.05	21	
MMBZ5256A	410	2	30	29.4	30.6	49	4.2	600	0.25	0.1	23	
MMBZ5256B	410	5	30	28.5	31.5	49	4.2	600	0.25	0.1	23	
BZX84B33	410	2	33	32.34	33.66	80	5	325	1	0.05	23.1	
BZX84C33	410	5	33	31.35	34.65	80	5	325	1	0.05	23.1	
MMBZ5257A	410	2	33	32.34	33.66	58	3.8	700	0.25	0.1	25	
MMBZ5257B	410	5	33	31.35	34.65	58	3.8	700	0.25	0.1	25	
BZX84B36	410	2	36	35.28	36.72	90	5	350	1	0.05	25.2	
BZX84C36	410	5	36	34.2	37.8	90	5	350	1	0.05	25.2	
MMBZ5258A	410	2	36	35.28	36.72	70	3.4	700	0.25	0.1	27	
MMBZ5258B	410	5	36	34.2	37.8	70	3.4	700	0.25	0.1	27	
BZX84B39	410	2	39	38.22	39.78	130	5	350	1	0.05	27.3	
BZX84C39	410	5	39	37.05	40.95	130	5	350	1	0.05	27.3	
MMBZ5259A	410	2	39	38.22	39.78	80	3.2	800	0.25	0.1	30	
MMBZ5259B	410	5	39	37.05	40.95	80	3.2	800	0.25	0.1	30	
BZX84B43	410	2	43	42.14	43.86	150	5	375	1	0.05	30.1	
BZX84C43	410	5	43	40.85	45.15	150	5	375	1	0.1	30.1	
MMBZ5260A	410	2	43	42.14	43.86	93	3	900	0.25	0.1	33	
MMBZ5260B	410	5	43	40.85	45.15	93	3	900	0.25	0.1	33	
BZX84B47	410	2	47	46.06	47.94	170	5	375	1	0.05	32.9	
BZX84C47	410	5	47	44.65	49.35	170	5	375	1	0.1	32.9	
MMBZ5261A	410	2	47	46.06	47.94	105	2.7	1000	0.25	0.1	36	
MMBZ5261B	410	5	47	44.65	49.35	105	2.7	1000	0.25	0.1	36	
BZX84B51	410	2	51	49.98	52.02	100	5	400	1	0.05	38	
BZX84C51	410	5	51	48.45	53.55	100	5	400	1	0.1	38	
MMBZ5262A	410	2	51	49.98	52.02	125	2.5	1100	0.25	0.1	39	
MMBZ5262B	410	5	51	48.45	53.55	125	2.5	1100	0.25	0.1	39	
BZX84B56	410	2	56	54.88	57.12	135	2.5	1000	1	0.1	42	
BZX84C56	410	5	56	53.2	58.8	135	2.5	1000	1	0.1	42	
BZX84B62	410	2	62	60.76	63.24	150	2.5	1000	1	0.1	46	
BZX84C62	410	5	62	58.9	65.1	150	2.5	1000	1	0.1	46	
BZX84B68	410	2	68	66.64	69.36	200	2.5	1000	1	0.1	51	
BZX84C68	410	5	68	64.6	71.4	200	2.5	1000	1	0.1	51	
BZX84B75	410	2	75	73.5	76.5	250	2.5	1000	1	0.1	56	
BZX84C75	410	5	75	71.25	78.75	250	2.5	1000	1	0.1	56	

Zener Diodes

Part Number	P _D	V _Z	V _Z @ I _{ZT} (V)			Z _{ZT} @ I _{ZT} Max.	I _{ZT}	Z _{ZK} @ I _{ZK} Max.	I _{ZK}	I _R @ V _R Max.		Package
	mW	%	Nom.	Min.	Max.	Ω	mA	Ω	mA	μA	V	
PZ1AFC2V5B	1000	5	2.5	2.37	2.63	15	40	1500	1	200	0.7	SMAF-C
PZ1AFC3V6B	1000	5	3.6	3.42	3.78	8	100	400	1	100	1	
PZ1AFC3V9B	1000	5	3.9	3.71	4.1	8	100	400	1	50	1	
PZ1AFC4V3B	1000	5	4.3	4.09	4.52	7	100	400	1	25	1	
PZ1AFC4V7B	1000	5	4.7	4.47	4.94	7	100	400	1	10	1	
PZ1AFC5V1B	1000	5	5.1	4.85	5.36	6	100	550	1	5	1	
PZ1AFC5V6B	1000	5	5.6	5.32	5.88	4	100	600	1	10	2	
PZ1AFC6V0B	1000	5	6	5.7	6.3	3	100	600	1	8	2	
PZ1AFC6V2B	1000	5	6.2	5.89	6.51	3	100	700	1	5	2	
PZ1AFC6V8B	1000	5	6.8	6.46	7.14	3	100	700	1	10	3	
PZ1AFC7V5B	1000	5	7.5	7.13	7.88	2	100	700	0.5	50	3	
PZ1AFC8V2B	1000	5	8.2	7.79	8.61	2	100	700	0.5	10	3	
PZ1AFC8V7B	1000	5	8.7	8.27	9.14	3	50	700	0.5	10	4	
PZ1AFC9V1B	1000	5	9.1	8.65	9.56	4	50	700	0.5	10	5	
PZ1AFC10B	1000	5	10	9.5	10.5	4	50	700	0.25	7	7.5	
PZ1AFC11B	1000	5	11	10.45	11.55	7	50	700	0.25	4	8.2	
PZ1AFC12B	1000	5	12	11.4	12.6	7	50	700	0.25	3	9.1	
PZ1AFC13B	1000	5	13	12.35	13.65	10	50	700	0.25	2	10	
PZ1AFC14B	1000	5	14	13.3	14.7	10	50	700	0.25	2	11	
PZ1AFC15B	1000	5	15	14.25	15.75	10	50	700	0.25	1	11	
PZ1AFC16B	1000	5	16	15.2	16.8	15	25	700	0.25	1	12	
PZ1AFC17B	1000	5	17	16.15	17.85	15	25	750	0.25	1	13	
PZ1AFC18B	1000	5	18	17.1	18.9	15	25	750	0.25	1	13	
PZ1AFC19B	1000	5	19	18.05	19.95	15	25	750	0.25	1	14	
PZ1AFC20B	1000	5	20	19	21	15	25	750	0.25	1	15	
PZ1AFC22B	1000	5	22	20.9	23.1	15	25	750	0.25	1	16	
PZ1AFC24B	1000	5	24	22.8	25.2	15	25	750	0.25	1	18	
PZ1AFC25B	1000	5	25	23.75	26.25	15	25	750	0.25	1	19	
PZ1AFC27B	1000	5	27	25.65	28.35	15	25	750	0.25	1	20	
PZ1AFC28B	1000	5	28	26.6	29.4	15	25	1000	0.25	1	21	
PZ1AFC30B	1000	5	30	28.5	31.5	15	25	1000	0.25	1	22	
PZ1AFC33B	1000	5	33	31.35	34.65	15	25	1000	0.25	1	24	
PZ1AFC36B	1000	5	36	34.2	37.8	40	10	1000	0.25	1	27	
PZ1AFC39B	1000	5	39	37.05	40.95	40	10	1000	0.25	1	30	
PZ1AFC43B	1000	5	43	40.85	45.15	45	10	1500	0.25	1	33	
PZ1AFC47B	1000	5	47	44.65	49.35	45	10	1500	0.25	1	36	
PZ1AFC51B	1000	5	51	48.45	53.55	60	10	1500	0.25	1	39	
PZ1AFC56B	1000	5	56	53.2	58.8	60	10	2000	0.25	1	43	
PZ1AFC62B	1000	5	62	58.9	65.1	80	10	2000	0.25	1	47	
PZ1AFC68B	1000	5	68	64.6	71.4	80	10	2000	0.25	1	51	
PZ1AFC75B	1000	5	75	71.25	78.75	100	10	2000	0.25	1	56	

Zener Diodes

Part Number	P _D	V _Z	V _Z @ I _{ZT} (V)			Z _{ZT} @ I _{ZT} Max.	I _{ZT}	Z _{ZK} @ I _{ZK} Max.	I _{ZK}	I _R @ V _R Max.		Package
	mW	%	Nom.	Min.	Max.	Ω	mA	Ω	mA	μA	V	
1SMA4728	1000	5	3.3	3.1	3.5	10	76	400	1	100	1	SMA
1SMA4730	1000	5	3.9	3.7	4.1	9	64	400	1	50	1	
1SMA4731	1000	5	4.3	4.1	4.5	9	58	400	1	10	1	
1SMA4732	1000	5	4.7	4.5	4.9	8	53	500	1	10	1	
1SMA4733	1000	5	5.1	4.8	5.4	7	49	550	1	10	1	
1SMA4734	1000	5	5.6	5.3	5.9	5	45	600	1	10	2	
1SMA4735	1000	5	6.2	5.9	6.5	2	41	700	1	10	3	
1SMA4736	1000	5	6.8	6.46	7.14	3.5	37	700	1	5	4	
1SMA4737	1000	5	7.5	7.125	7.875	4	34	700	0.5	5	5	
1SMA4738	1000	5	8.2	7.79	8.61	4.5	31	700	0.5	5	6	
1SMA4739	1000	5	9.1	8.645	9.555	5	28	700	0.5	0.5	7	
1SMA4740	1000	5	10	9.5	10.5	7	25	700	0.25	0.5	7.6	
1SMA4741	1000	5	11	10.45	11.55	8	23	700	0.25	0.1	8.4	
1SMA4742	1000	5	12	11.4	12.6	9	21	700	0.25	0.1	9.1	
1SMA4743	1000	5	13	12.35	13.65	10	19	700	0.25	0.1	9.9	
1SMA4744	1000	5	15	14.25	15.75	14	17	700	0.25	0.1	11.4	
1SMA4745	1000	5	16	15.2	16.8	16	15.5	700	0.25	0.1	12.2	
1SMA4746	1000	5	18	17.1	18.9	20	14	750	0.25	0.1	13.7	
1SMA4747	1000	5	20	19	21	22	12.5	750	0.25	0.1	15.2	
1SMA4748	1000	5	22	20.9	23.1	23	11.5	750	0.25	0.1	16.7	
1SMA4749	1000	5	24	22.8	25.2	25	10.5	750	0.25	0.1	18.2	
1SMA4750	1000	5	27	25.65	28.35	35	9.5	750	0.25	0.1	20.6	
1SMA4751	1000	5	30	28.5	31.5	40	8.5	1000	0.25	0.1	22.8	
1SMA4752	1000	5	33	31.35	34.65	45	7.5	1000	0.25	0.1	25.1	
1SMA4753	1000	5	36	34.2	37.8	50	7	1000	0.25	0.1	27.4	
1SMA4754	1000	5	39	37.05	40.95	60	6.5	1000	0.25	0.1	29.7	
1SMA4755	1000	5	43	40.85	45.15	70	6	1500	0.25	0.1	32.7	
1SMA4756	1000	5	47	44.65	49.35	80	5.5	1500	0.25	0.1	35.8	
1SMA4757	1000	5	51	48.45	53.55	95	5	1500	0.25	0.1	38.8	
1SMA5921	1500	5	6.8	6.46	7.14	2.5	55.1	200	1	5	5.2	
1SMA5922	1500	5	7.5	7.125	7.875	3	50	400	0.5	5	6	
1SMA5923	1500	5	8.2	7.79	8.61	3.5	45.7	400	0.5	5	6.5	
1SMA5924	1500	5	9.1	8.645	9.555	4	41.2	500	0.5	5	7	
1SMA5925	1500	5	10	9.5	10.5	4.5	37.5	500	0.25	5	8	
1SMA5926	1500	5	11	10.45	11.55	5.5	34.1	550	0.25	1	8.4	
1SMA5927	1500	5	12	11.4	12.6	6.5	31.2	550	0.25	1	9.1	
1SMA5928	1500	5	13	12.35	13.65	7	28.8	550	0.25	1	9.9	
1SMA5929	1500	5	15	14.25	15.75	9	25	600	0.25	1	11.4	
1SMA5930	1500	5	16	15.2	16.8	10	23.4	600	0.25	1	12.2	
1SMA5931	1500	5	18	17.1	18.9	12	20.8	650	0.25	1	13.7	
1SMA5932	1500	5	20	19	21	14	18.7	650	0.25	1	15.2	
1SMA5933	1500	5	22	20.9	23.1	17.5	17	650	0.25	1	16.7	
1SMA5934	1500	5	24	22.8	25.2	19	15.6	700	0.25	1	18.2	
1SMA5935	1500	5	27	25.65	28.35	23	13.9	700	0.25	1	20.6	
1SMA5936	1500	5	30	28.5	31.5	26	12.5	750	0.25	1	22.8	
1SMA5937	1500	5	33	31.35	34.65	33	11.4	800	0.25	1	25.1	
1SMA5938	1500	5	36	34.2	37.8	38	10.4	850	0.25	1	27.4	
1SMA5939	1500	5	39	37.05	40.95	45	9.6	900	0.25	1	29.7	
1SMA5940	1500	5	43	40.85	45.15	53	8.7	950	0.25	1	32.7	
1SMA5941	1500	5	47	44.65	49.35	67	8	1000	0.25	1	35.8	
1SMA5942	1500	5	51	48.45	53.55	70	7.3	1100	0.25	1	38.8	
1SMA5943	1500	5	56	53.2	58.8	86	6.7	1300	0.25	1	42.6	
1SMA5944	1500	5	62	58.9	65.1	100	6	1500	0.25	1	47.2	
1SMA5945	1500	5	68	64.6	71.4	120	5.5	1700	0.25	1	51.7	

Zener Diodes

Part Number	P _D	V _Z	V _Z @ I _{ZT} (V)			Z _{ZT} @ I _{ZT} Max.	I _{ZT}	Z _{ZK} @ I _{ZK} Max.	I _{ZK}	I _R @ V _R Max.		Package
	mW	%	Nom.	Min.	Max.	Ω	mA	Ω	mA	μA	V	
1SMB5921	1500	5	6.8	6.46	7.14	2.5	55.1	200	1	5	5.2	SMB
1SMB5922	1500	5	7.5	7.125	7.875	3	50	400	0.5	5	6	
1SMB5923	1500	5	8.2	7.79	8.61	3.5	45.7	400	0.5	5	6.5	
1SMB5924	1500	5	9.1	8.645	9.555	4	41.2	500	0.5	5	7	
1SMB5925	1500	5	10	9.5	10.5	4.5	37.5	500	0.25	5	8	
1SMB5926	1500	5	11	10.45	11.55	5.5	34.1	550	0.25	1	8.4	
1SMB5927	1500	5	12	11.4	12.6	6.5	31.2	550	0.25	1	9.1	
1SMB5928	1500	5	13	12.35	13.65	7	28.8	550	0.25	1	9.9	
1SMB5929	1500	5	15	14.25	15.75	9	25	600	0.25	1	11.4	
1SMB5930	1500	5	16	15.2	16.8	10	23.4	600	0.25	1	12.2	
1SMB5931	1500	5	18	17.1	18.9	12	20.8	650	0.25	1	13.7	
1SMB5932	1500	5	20	19	21	14	18.7	650	0.25	1	15.2	
1SMB5933	1500	5	22	20.9	23.1	17.5	17	650	0.25	1	16.7	
1SMB5934	1500	5	24	22.8	25.2	19	15.6	700	0.25	1	18.2	
1SMB5935	1500	5	27	25.65	28.35	23	13.9	700	0.25	1	20.6	
1SMB5936	1500	5	30	28.5	31.5	26	12.5	750	0.25	1	22.8	
1SMB5937	1500	5	33	31.35	34.65	33	11.4	800	0.25	1	25.1	
1SMB5938	1500	5	36	34.2	37.8	38	10.4	850	0.25	1	27.4	
1SMB5939	1500	5	39	37.05	40.95	45	9.6	900	0.25	1	29.7	
1SMB5940	1500	5	43	40.85	45.15	53	8.7	950	0.25	1	32.7	
1SMB5941	1500	5	47	44.65	49.35	67	8	1000	0.25	1	35.8	
1SMB5942	1500	5	51	48.45	53.55	70	7.3	1100	0.25	1	38.8	
1SMB2EZ6.8	2000	5	6.8	6.46	7.14	2	73.5	700	1	5	4	
1SMB2EZ7.5	2000	5	7.5	7.125	7.875	2	66.5	700	0.5	5	5	
1SMB2EZ8.2	2000	5	8.2	7.79	8.61	2.3	61	700	0.5	5	6	
1SMB2EZ8.7	2000	5	8.7	8.265	9.135	2.4	58	700	0.5	4	6.6	
1SMB2EZ9.1	2000	5	9.1	8.645	9.555	2.5	55	700	0.5	3	7	
1SMB2EZ10	2000	5	10	9.5	10.5	3.5	50	700	0.25	3	7.6	
1SMB2EZ11	2000	5	11	10.45	11.55	4	45.5	700	0.25	1	8.4	
1SMB2EZ12	2000	5	12	11.4	12.6	4.5	41.5	700	0.25	1	9.1	
1SMB2EZ13	2000	5	13	12.35	13.65	5	38.5	700	0.25	0.5	9.9	
1SMB2EZ14	2000	5	14	13.3	14.7	5.5	35.7	700	0.25	0.5	10.6	
1SMB2EZ15	2000	5	15	14.25	15.75	7	33.4	700	0.25	0.5	11.4	
1SMB2EZ16	2000	5	16	15.2	16.8	8	31.2	700	0.25	0.5	12.2	
1SMB2EZ17	2000	5	17	16.15	17.85	9	29.4	750	0.25	0.5	13	
1SMB2EZ18	2000	5	18	17.1	18.9	10	27.8	750	0.25	0.5	13.7	
1SMB2EZ19	2000	5	19	18.05	19.95	11	26.3	750	0.25	0.5	14.4	
1SMB2EZ20	2000	5	20	19	21	11	25	750	0.25	0.5	15.2	
1SMB2EZ22	2000	5	22	20.9	23.1	12	22.8	750	0.25	0.5	16.7	
1SMB2EZ24	2000	5	24	22.8	25.2	13	20.8	750	0.25	0.5	18.2	

Zener Diodes

Part Number	P _D	V _Z	V _Z @ I _{ZT} (V)			Z _{ZT} @ I _{ZT} Max.	I _{ZT}	Z _{ZK} @ I _{ZK} Max.	I _{ZK}	I _R @ V _R Max.		Package
	mW	%	Nom.	Min.	Max.	Ω	mA	Ω	mA	μA	V	
1SMB2EZ25	2000	5	25	23.75	26.25	14	20	750	0.25	0.5	19	SMB
1SMB2EZ27	2000	5	27	25.65	28.35	18	18.5	750	0.25	0.5	20.6	
1SMB2EZ28	2000	5	28	26.6	29.4	18	17	750	0.25	0.5	21.3	
1SMB2EZ30	2000	5	30	28.5	31.5	20	16.6	1000	0.25	0.5	22.5	
1SMB2EZ33	2000	5	33	31.35	34.65	23	15.1	1000	0.25	0.5	25.1	
1SMB2EZ36	2000	5	36	34.2	37.8	25	13.9	1000	0.25	0.5	27.4	
1SMB2EZ39	2000	5	39	37.05	40.95	30	12.8	1000	0.25	0.5	29.7	
1SMB2EZ43	2000	5	43	40.85	45.15	35	11.6	1500	0.25	0.5	32.7	
1SMB2EZ47	2000	5	47	44.65	49.35	40	10.6	1500	0.25	0.5	35.8	
1SMB2EZ51	2000	5	51	48.45	53.55	48	9.8	1500	0.25	0.5	38.8	
1SMB3EZ5.6	3000	5	5.6	5.32	5.88	2	134	700	1	5	3	
1SMB3EZ6.2	3000	5	6.2	5.89	6.51	2	120	700	1	5	4	
1SMB3EZ6.8	3000	5	6.8	6.46	7.14	2	110	700	1	5	4	
1SMB3EZ7.5	3000	5	7.5	7.125	7.875	2	100	700	0.5	5	5	
1SMB3EZ8.2	3000	5	8.2	7.79	8.61	2.3	91	700	0.5	5	6	
1SMB3EZ8.7	3000	5	8.7	8.265	9.135	2.4	85	700	0.5	4	6.6	
1SMB3EZ9.1	3000	5	9.1	8.645	9.555	2.5	82	700	0.5	3	7	
1SMB3EZ10	3000	5	10	9.5	10.5	3.5	75	700	0.25	3	7.6	
1SMB3EZ11	3000	5	11	10.45	11.55	4	68	700	0.25	1	8.4	
1SMB3EZ12	3000	5	12	11.4	12.6	4.5	63	700	0.25	1	9.1	
1SMB3EZ13	3000	5	13	12.35	13.65	4.5	58	700	0.25	0.5	9.9	
1SMB3EZ14	3000	5	14	13.3	14.7	5	53	700	0.25	0.5	10.6	
1SMB3EZ15	3000	5	15	14.25	15.75	5.5	50	700	0.25	0.5	11.4	
1SMB3EZ16	3000	5	16	15.2	16.8	5.5	47	700	0.25	0.5	12.2	
1SMB3EZ17	3000	5	17	16.15	17.85	6	44	750	0.25	0.5	13	
1SMB3EZ18	3000	5	18	17.1	18.9	6	42	750	0.25	0.5	13.7	
1SMB3EZ19	3000	5	19	18.05	19.95	7	40	750	0.25	0.5	14.4	
1SMB3EZ20	3000	5	20	19	21	7	37	750	0.25	0.5	15.2	
1SMB3EZ22	3000	5	22	20.9	23.1	8	34	750	0.25	0.5	16.7	
1SMB3EZ24	3000	5	24	22.8	25.2	9	31	750	0.25	0.5	18.2	
1SMB3EZ25	3000	5	25	23.75	26.25	9.5	30	750	0.25	0.5	19	
1SMB3EZ27	3000	5	27	25.65	28.35	10	28	750	0.25	0.5	20.6	
1SMB3EZ28	3000	5	28	26.6	29.4	12	27	750	0.25	0.5	21.3	
1SMB3EZ30	3000	5	30	28.5	31.5	16	25	1000	0.25	0.5	22.5	
1SMB3EZ33	3000	5	33	31.35	34.65	20	23	1000	0.25	0.5	25.1	
1SMB3EZ36	3000	5	36	34.2	37.8	22	21	1000	0.25	0.5	27.4	
1SMB3EZ39	3000	5	39	37.05	40.95	28	19	1000	0.25	0.5	29.7	
1SMB3EZ43	3000	5	43	40.85	45.15	33	17	1500	0.25	0.5	32.7	
1SMB3EZ47	3000	5	47	44.65	49.35	38	16	1500	0.25	0.5	35.8	
1SMB3EZ51	3000	5	51	48.45	53.55	45	15	1500	0.25	0.5	38.8	

Zener Diodes

Part Number	P _D	V _Z	V _Z @ I _{ZT}			Z _{ZT} @ I _{ZT}	I _{ZT}	Z _{ZK} @ I _{ZK}	I _{ZK}	I _R @ V _R		Package
	mW	%	Nom.	Min.	Max.	Ω	mA	Ω	mA	μA	V	
1SMC5338	5000	5	5.1	4.845	5.355	2	240	400	1	10	1	SMC
1SMC5339	5000	5	5.6	5.32	5.88	1	220	400	1	10	2	
1SMC5340	5000	5	6	5.7	6.3	1	200	300	1	10	3	
1SMC5341	5000	5	6.2	5.89	6.51	1	200	200	1	10	3	
1SMC5342	5000	5	6.8	6.46	7.14	1	175	200	1	10	5.2	
1SMC5343	5000	5	7.5	7.125	7.875	1.5	175	200	1	10	5.7	
1SMC5344	5000	5	8.2	7.79	8.61	1.5	150	200	1	10	6.2	
1SMC5345	5000	5	8.7	8.265	9.135	2	150	200	1	10	6.6	
1SMC5346	5000	5	9.1	8.645	9.555	2	150	150	1	7.5	6.9	
1SMC5347	5000	5	10	9.5	10.5	2	125	125	1	5	7.6	
1SMC5348	5000	5	11	10.45	11.55	2.5	125	125	1	5	8.4	
1SMC5349	5000	5	12	11.4	12.6	2.5	100	125	1	2	9.1	
1SMC5350	5000	5	13	12.35	13.65	2.5	100	100	1	1	9.9	
1SMC5351	5000	5	14	13.3	14.7	2.5	100	75	1	1	10.6	
1SMC5352	5000	5	15	14.25	15.75	2.5	75	75	1	1	11.5	
1SMC5353	5000	5	16	15.2	16.8	2.5	75	75	1	1	12.2	
1SMC5354	5000	5	17	16.15	17.85	2.5	70	75	1	0.5	12.9	
1SMC5355	5000	5	18	17.1	18.9	2.5	65	75	1		13.7	
1SMC5356	5000	5	19	18.05	19.95	3	65	75	1	0.5	14.4	
1SMC5357	5000	5	20	19	21	3	65	75	1	0.5	15.2	
1SMC5358	5000	5	22	20.9	23.1	3.5	50	75	1	0.5	16.7	
1SMC5359	5000	5	24	22.8	25.2	3.5	50	100	1	0.5	18.2	
1SMC5360	5000	5	25	23.75	26.25	4	50	110	1	0.5	19	
1SMC5361	5000	5	27	25.65	28.35	5	50	120	1	0.5	20.6	
1SMC5362	5000	5	28	26.6	29.4	6	50	130	1	0.5	21.2	
1SMC5363	5000	5	30	28.5	31.5	8	40	140	1	0.5	22.8	
1SMC5364	5000	5	33	31.35	34.65	10	40	150	1	0.5	25.1	
1SMC5365	5000	5	36	34.2	37.8	11	30	160	1	0.5	27.4	
1SMC5366	5000	5	39	37.05	40.95	14	30	170	1	0.5	29.7	
1SMC5367	5000	5	43	40.85	45.15	20	30	190	1	0.5	32.7	
1SMC5368	5000	5	47	44.65	49.35	25	25	210	1	0.5	35.8	
1SMC5369	5000	5	51	48.45	53.55	27	25	230	1	0.5	38.8	

Zener Diodes

Part Number	P _D	V _Z	V _Z @ I _{ZT} (V)			Z _{VT} @ I _{ZT} Max.	I _{ZT}	Z _{ZK} @ I _{ZK} Max.	I _{ZK}	I _R @ V _R Max.		Package
	mW	%	Nom.	Min.	Max.	Ω	mA	Ω	mA	μA	V	
2EZ6.8	2000	5	6.8	6.46	7.14	2	73.5	700	1	5	4	DO-15
2EZ7.5	2000	5	7.5	7.125	7.875	2	66.5	700	0.5	5	5	
2EZ8.2	2000	5	8.2	7.79	8.61	2.3	61	700	0.5	5	6	
2EZ8.7	2000	5	8.7	8.265	9.135	2.4	58	700	0.5	4	6.6	
2EZ9.1	2000	5	9.1	8.645	9.555	2.5	55	700	0.5	3	7	
2EZ10	2000	5	10	9.5	10.5	3.5	50	700	0.25	3	7.6	
2EZ11	2000	5	11	10.45	11.55	4	45.5	700	0.25	1	8.4	
2EZ12	2000	5	12	11.4	12.6	4.5	41.5	700	0.25	1	9.1	
2EZ13	2000	5	13	12.35	13.65	5	38.5	700	0.25	0.5	9.9	
2EZ14	2000	5	14	13.3	14.7	5.5	35.7	700	0.25	0.5	10.6	
2EZ15	2000	5	15	14.25	15.75	7	33.4	700	0.25	0.5	11.4	
2EZ16	2000	5	16	15.2	16.8	8	31.2	700	0.25	0.5	12.2	
2EZ17	2000	5	17	16.15	17.85	9	29.4	750	0.25	0.5	13	
2EZ18	2000	5	18	17.1	18.9	10	27.8	750	0.25	0.5	13.7	
2EZ19	2000	5	19	18.05	19.95	11	26.3	750	0.25	0.5	14.4	
2EZ20	2000	5	20	19	21	11	25	750	0.25	0.5	15.2	
2EZ22	2000	5	22	20.9	23.1	12	22.8	750	0.25	0.5	16.7	
2EZ24	2000	5	24	22.8	25.2	13	20.8	750	0.25	0.5	18.2	
2EZ25	2000	5	25	23.75	26.25	14	20	750	0.25	0.5	19	
2EZ27	2000	5	27	25.65	28.35	18	18.5	750	0.25	0.5	20.6	
2EZ28	2000	5	28	26.6	29.4	18	17	750	0.25	0.5	21.3	
2EZ30	2000	5	30	28.5	31.5	20	16.6	1000	0.25	0.5	22.5	
2EZ33	2000	5	33	31.35	34.65	23	15.1	1000	0.25	0.5	25.1	
2EZ36	2000	5	36	34.2	37.8	25	13.9	1000	0.25	0.5	27.4	
2EZ39	2000	5	39	37.05	40.95	30	12.8	1000	0.25	0.5	29.7	
2EZ43	2000	5	43	40.85	45.15	35	11.6	1500	0.25	0.5	32.7	
2EZ47	2000	5	47	44.65	49.35	40	10.6	1500	0.25	0.5	35.8	
2EZ51	2000	5	51	48.45	53.55	48	9.8	1500	0.25	0.5	38.8	
3EZ6.8	3000	5	6.8	6.46	7.14	2	110	700	1	5	4	
3EZ7.5	3000	5	7.5	7.125	7.875	2	100	700	0.5	5	5	
3EZ8.2	3000	5	8.2	7.79	8.61	2.3	91	700	0.5	5	6	
3EZ8.7	3000	5	8.7	8.265	9.135	2.4	85	700	0.5	4	6.6	
3EZ9.1	3000	5	9.1	8.645	9.555	2.5	82	700	0.5	3	7	
3EZ10	3000	5	10	9.5	10.5	3.5	75	700	0.25	3	7.6	
3EZ11	3000	5	11	10.45	11.55	4	68	700	0.25	1	8.4	
3EZ12	3000	5	12	11.4	12.6	4.5	63	700	0.25	1	9.1	
3EZ13	3000	5	13	12.35	13.65	4.5	58	700	0.25	0.5	9.9	
3EZ14	3000	5	14	13.3	14.7	5	53	700	0.25	0.5	10.6	
3EZ15	3000	5	15	14.25	15.75	5.5	50	700	0.25	0.5	11.4	
3EZ16	3000	5	16	15.2	16.8	5.5	47	700	0.25	0.5	12.2	
3EZ17	3000	5	17	16.15	17.85	6	44	750	0.25	0.5	13	
3EZ18	3000	5	18	17.1	18.9	6	42	750	0.25	0.5	13.7	
3EZ19	3000	5	19	18.05	19.95	7	40	750	0.25	0.5	14.4	
3EZ20	3000	5	20	19	21	7	37	750	0.25	0.5	15.2	
3EZ22	3000	5	22	20.9	23.1	8	34	750	0.25	0.5	16.7	
3EZ24	3000	5	24	22.8	25.2	9	31	750	0.25	0.5	18.2	
3EZ25	3000	5	25	23.75	26.25	9.5	30	750	0.25	0.5	19	
3EZ27	3000	5	27	25.65	28.35	10	28	750	0.25	0.5	20.6	
3EZ28	3000	5	28	26.6	29.4	12	27	750	0.25	0.5	21.3	
3EZ30	3000	5	30	28.5	31.5	16	25	1000	0.25	0.5	22.5	
3EZ33	3000	5	33	31.35	34.65	20	23	1000	0.25	0.5	25.1	
3EZ36	3000	5	36	34.2	37.8	22	21	1000	0.25	0.5	27.4	
3EZ39	3000	5	39	37.05	40.95	28	19	1000	0.25	0.5	29.7	
3EZ43	3000	5	43	40.85	45.15	33	17	1500	0.25	0.5	32.7	
3EZ47	3000	5	47	44.65	49.35	38	16	1500	0.25	0.5	35.8	
3EZ51	3000	5	51	48.45	53.55	45	15	1500	0.25	0.5	38.8	
1N5347BS	5000	5	10	9.5	10.5	2	125	125	1	5	7.6	
1N5353BS	5000	5	16	15.5	16.8	2.5	75	75	1	1	12.2	
1N5354BS	5000	5	17	16.15	17.85	2.5	70	75	1	0.5	12.9	
1N5369BS	5000	5	51	48.45	53.55	27	25	230	1	0.5	38.8	

Zener Diodes

Part Number	P _D	V _Z	V _Z @ I _{ZT} (V)			Z _{ZT} @ I _{ZT} Max.	I _{ZT}	Z _{ZK} @ I _{ZK} Max.	I _{ZK}	I _R @ V _R Max.		Package
	mW	%	Nom.	Min.	Max.	Ω	mA	Ω	mA	μA	V	
1N4728A	1000	5	3.3	3.1	3.5	10	76	400	1	100	1	DO-41
1N4730A	1000	5	3.9	3.7	4.1	9	64	400	1	50	1	
1N4731A	1000	5	4.3	4.1	4.5	9	58	400	1	10	1	
1N4732A	1000	5	4.7	4.5	4.9	8	53	500	1	10	1	
1N4733A	1000	5	5.1	4.8	5.4	7	49	550	1	10	1	
1N4734A	1000	5	5.6	5.3	5.9	5	45	600	1	10	2	
1N4735A	1000	5	6.2	5.9	6.5	2	41	700	1	10	3	
1N4736A	1000	5	6.8	6.46	7.14	3.5	37	700	1	5	4	
1N4737A	1000	5	7.5	7.125	7.875	4	34	700	0.5	5	5	
1N4738A	1000	5	8.2	7.79	8.61	4.5	31	700	0.5	5	6	
1N4739A	1000	5	9.1	8.645	9.555	5	28	700	0.5	0.5	7	
1N4740A	1000	5	10	9.5	10.5	7	25	700	0.25	0.5	7.6	
1N4741A	1000	5	11	10.45	11.55	8	23	700	0.25	0.1	8.4	
1N4742A	1000	5	12	11.4	12.6	9	21	700	0.25	0.1	9.1	
1N4743A	1000	5	13	12.35	13.65	10	19	700	0.25	0.1	9.9	
1N4744A	1000	5	15	14.25	15.75	14	17	700	0.25	0.1	11.4	
1N4745A	1000	5	16	15.2	16.8	16	15.5	700	0.25	0.1	12.2	
1N4746A	1000	5	18	17.1	18.9	20	14	750	0.25	0.1	13.7	
1N4747A	1000	5	20	19	21	22	12.5	750	0.25	0.1	15.2	
1N4748A	1000	5	22	20.9	23.1	23	11.5	750	0.25	0.1	16.7	
1N4749A	1000	5	24	22.8	25.2	25	10.5	750	0.25	0.1	18.2	
1N4750A	1000	5	27	25.65	28.35	35	9.5	750	0.25	0.1	20.6	
1N4751A	1000	5	30	28.5	31.5	40	8.5	1000	0.25	0.1	22.8	
1N4752A	1000	5	33	31.35	34.65	45	7.5	1000	0.25	0.1	25.1	
1N4753A	1000	5	36	34.2	37.8	50	7	1000	0.25	0.1	27.4	
1N4754A	1000	5	39	37.05	40.95	60	6.5	1000	0.25	0.1	29.7	
1N4755A	1000	5	43	40.85	45.15	70	6	1500	0.25	0.1	32.7	
1N4756A	1000	5	47	44.65	49.35	80	5.5	1500	0.25	0.1	35.8	
1N4757A	1000	5	51	48.45	53.55	95	5	1500	0.25	0.1	38.8	
1N4758A	1000	5	56	53.2	58.8	110	4.5	2000	0.25	5	42.6	
1N4759A	1000	5	62	58.9	65.1	125	4	2000	0.25	5	47.1	
1N4760A	1000	5	68	64.6	71.4	150	3.7	2000	0.25	5	51.7	
1N5921B	1500	5	6.8	6.46	7.14	2.5	55.1	200	1	5	5.2	
1N5922B	1500	5	7.5	7.125	7.875	3	50	400	0.5	5	6	
1N5923B	1500	5	8.2	7.79	8.61	3.5	45.7	400	0.5	5	6.5	







Zener Diodes

Part Number	P _D	V _Z	V _Z @ I _{ZT} (V)			Z _{ZT} @ I _{ZT} Max.	I _{ZT}	Z _{ZK} @ I _{ZK} Max.	I _{ZK}	I _R @ V _R Max.		Package
	mW	%	Nom.	Min.	Max.	Ω	mA	Ω	mA	μA	V	
1N5924B	1500	5	9.1	8.645	9.555	4	41.2	500	0.5	5	7	DO-41
1N5925B	1500	5	10	9.5	10.5	4.5	37.5	500	0.25	5	8	
1N5926B	1500	5	11	10.45	11.55	5.5	34.1	550	0.25	1	8.4	
1N5927B	1500	5	12	11.4	12.6	6.5	31.2	550	0.25	1	9.1	
1N5928B	1500	5	13	12.35	13.65	7	28.8	550	0.25	1	9.9	
1N5929B	1500	5	15	14.25	15.75	9	25	600	0.25	1	11.4	
1N5930B	1500	5	16	15.2	16.8	10	23.4	600	0.25	1	12.2	
1N5931B	1500	5	18	17.1	18.9	12	20.8	650	0.25	1	13.7	
1N5932B	1500	5	20	19	21	14	18.7	650	0.25	1	15.2	
1N5933B	1500	5	22	20.9	23.1	17.5	17	650	0.25	1	16.7	
1N5934B	1500	5	24	22.8	25.2	19	15.6	700	0.25	1	18.2	
1N5935B	1500	5	27	25.65	28.35	23	13.9	700	0.25	1	20.6	
1N5936B	1500	5	30	28.5	31.5	26	12.5	750	0.25	1	22.8	
1N5937B	1500	5	33	31.35	34.65	33	11.4	800	0.25	1	25.1	
1N5938B	1500	5	36	34.2	37.8	38	10.4	850	0.25	1	27.4	
1N5939B	1500	5	39	37.05	40.95	45	9.6	900	0.25	1	29.7	
1N5940B	1500	5	43	40.85	45.15	53	8.7	950	0.25	1	32.7	
1N5941B	1500	5	47	44.65	49.35	67	8	1000	0.25	1	35.8	
1N5942B	1500	5	51	48.45	53.55	70	7.3	1100	0.25	1	38.8	
3EZ5.6S	3000	5	5.6	5.32	5.88	5	45	600	1	10	2	
3EZ6.2S	3000	5	6.2	5.89	6.51	2	41	700	1	5	3	
3EZ6.8S	3000	5	6.8	6.46	7.14	3.5	37	700	1	5	4	
3EZ8.2S	3000	5	8.2	7.79	8.61	4.5	31	700	1	5	6	
3EZ9.1S	3000	5	9.1	8.64	9.56	5	28	700	0.5	3	7	
3EZ10S	3000	5	10	9.5	10.5	5	37.5	500	0.25	3	7.6	
3EZ11S	3000	5	11	10.45	11.55	6	34.1	550	0.25	1	8.4	
3EZ12S	3000	5	12	11.4	12.6	9	21	700	0.25	1	9.1	
3EZ13S	3000	5	13	12.35	13.65	10	19	700	0.25	0.5	9.9	
3EZ15S	3000	5	15	14.25	15.75	14	17	700	0.25	0.5	11.4	
3EZ18S	3000	5	18	17.1	18.9	20	14	750	0.25	0.5	13.7	
3EZ20S	3000	5	20	19	21	22	12.5	750	0.25	0.5	15.2	
3EZ22S	3000	5	22	20.9	23.1	23	11.5	750	0.25	0.5	16.7	
3EZ24S	3000	5	24	22.8	25.2	25	10.5	750	0.25	0.5	18.2	
3EZ27S	3000	5	27	25.65	28.35	35	9.5	750	0.25	0.5	20.6	
3EZ43S	3000	5	43	40.85	45.15	70	6	1500	0.25	0.5	32.7	
3EZ47S	3000	5	47	44.65	49.35	80	5.5	1500	0.25	0.5	35.8	

Zener Diodes

Part Number	P _D	V _Z	V _Z @ I _{ZT} (V)			Z _{ZT} @ I _{ZT} Max.	I _{ZT}	Z _{ZK} @ I _{ZK} Max.	I _{ZK}	I _R @ V _R Max.		Package
	mW	%	Nom.	Min.	Max.	Ω	mA	Ω	mA	μA	V	
1N5338B	5000	5	5.1	4.85	5.36	2	240	400	1	10	1	DO-201AE
1N5339B	5000	5	5.6	5.32	5.88	1	220	400	1	10	2	
1N5340B	5000	5	6	5.7	6.3	1	200	300	1	10	3	
1N5341B	5000	5	6.2	5.89	6.51	1	200	200	1	10	3	
1N5342B	5000	5	6.8	6.46	7.14	1	175	200	1	10	5.2	
1N5343B	5000	5	7.5	7.125	7.875	1.5	175	200	1	10	5.7	
1N5344B	5000	5	8.2	7.79	8.61	1.5	150	200	1	10	6.2	
1N5345B	5000	5	8.7	8.265	9.135	2	150	200	1	10	6.6	
1N5346B	5000	5	9.1	8.645	9.555	2	150	150	1	7.5	6.9	
1N5347B	5000	5	10	9.5	10.5	2	125	125	1	5	7.6	
1N5348B	5000	5	11	10.45	11.55	2.5	125	125	1	5	8.4	
1N5349B	5000	5	12	11.4	12.6	2.5	100	125	1	2	9.1	
1N5350B	5000	5	13	12.35	13.65	2.5	100	100	1	1	9.9	
1N5351B	5000	5	14	13.3	14.7	2.5	100	75	1	1	10.6	
1N5352B	5000	5	15	14.25	15.75	2.5	75	75	1	1	11.5	
1N5353B	5000	5	16	15.2	16.8	2.5	75	75	1	1	12.2	
1N5354B	5000	5	17	16.15	17.85	2.5	70	75	1	0.5	12.9	
1N5355B	5000	5	18	17.1	18.9	2.5	65	75	1	0.5	13.7	
1N5356B	5000	5	19	18.05	19.95	3	65	75	1	0.5	14.4	
1N5357B	5000	5	20	19	21	3	65	75	1	0.5	15.2	
1N5358B	5000	5	22	20.9	23.1	3.5	50	75	1	0.5	16.7	
1N5359B	5000	5	24	22.8	25.2	3.5	50	100	1	0.5	18.2	
1N5360B	5000	5	25	23.75	26.25	4	50	110	1	0.5	19	
1N5361B	5000	5	27	25.65	28.35	5	50	120	1	0.5	20.6	
1N5362B	5000	5	28	26.6	29.4	6	50	130	1	0.5	21.2	
1N5363B	5000	5	30	28.5	31.5	8	40	140	1	0.5	22.8	
1N5364B	5000	5	33	31.35	34.65	10	40	150	1	0.5	25.1	
1N5365B	5000	5	36	34.2	37.8	11	30	160	1	0.5	27.4	
1N5366B	5000	5	39	37.05	40.95	14	30	170	1	0.5	29.7	
1N5367B	5000	5	43	40.85	45.15	20	30	190	1	0.5	32.7	
1N5368B	5000	5	47	44.65	49.35	25	25	210	1	0.5	35.8	
1N5369B	5000	5	51	48.45	53.55	27	25	230	1	0.5	38.8	

ESD Protection

Part Number	UNI/BI	Ch.	V_{RWM}	V_{BR}	$I_R @ V_{RWM}$	$V_C @ I_{PP}$	I_{PP}	C_J	Package	Circuit Figure
			Min.	Max.	Max.	Max.		Max.		
			V	V	μA	V	A	pF		
PE1605S1Q	UNI	1	5	5.5	0.05	15	3	0.3	DFN0603-2L	
PEC11SD03S1Q	BI	1	5	4.5	1	7.5	3.5	0.19	DFN0603-2L	
PS1101-D32*	Bi	1	1	1.3	1	11.6	4	0.09		
PS1103-D32*	Bi	1	3.3	1.3	1	5.5	3.5	0.09		
PS1105-D32*	Bi	1	5	6	0.5	5.9	3	0.09		
PS1201-D32*	Bi	1	1	1.5	0.5	6.5	6.5	0.2		
PS1202-D32*	Bi	1	1.5	4	0.5	4.1	5	0.19		
PS1203-D32*	Bi	1	3.3	4	0.5	4.1	5	0.19		
PS1205-D32*	Bi	1	5	6	0.5	4.4	5	0.19		
PS120M-D32*	Bi	1	24	28	1	5	4	0.2		
PS120P-D32*	Bi	1	28	28	1	5	4	0.2		
PS1223-D32*	Bi	1	2.8	4	0.5	4.1	5	0.17		
PS1405-D32*	Bi	1	5	6	0.5	4.4	7	0.42		
PS140M-D32*	Bi	1	24	25.5	0.5	3	10	0.5		
PS150P-D32*	Bi	1	28	29.5	0.5	3	10	0.5	DFN0603-2L	
PS150T-D32*	Bi	1	36	37.5	0.5	3	10	0.5		
PS160M-D32*	Bi	1	24	28	1	3	10	0.6		
PS1703-D32*	Bi	1	3.3	5.5	0.5	2.6	12	0.7	DFN0603-2L	
PEC3202S1Q	BI	1	2.5	2.6	0.5	9	10	20		
PEC3203S1Q	BI	1	3.3	3.5	0.5	9	10	20		
PS1705-D32*	Bi	1	5	6	0.5	3	12	0.7	DFN0603-2L	
PEC3205S1Q	BI	1	5	5.5	0.5	13	5	20		
PE1403M1Q	UNI	1	3.3	4	0.05	9	1	0.4		
PE1605M1Q	UNI	1	5	5.5	0.05	10	1	0.35	DFN1006-2L	
PE3212M1Q	UNI	1	12	12.5	1	25	2.5	20		
PE3307M1Q	UNI	1	7	7.5	1	12	1	30		
PE3620M1Q	UNI	1	20	22	0.1	35	8	60		
PE4205M1Q	UNI	1	5	6	1	13.5	25	250		
PE4207M1Q	UNI	1	7	7.8	1	13.5	21	200		
PJE24VM5FN2	UNI	1	24	25	0.1	45	3	50		
PJE28VM2FN2	UNI	1	28	29	0.5	55	3	25		
PEC11SD03M1Q	BI	1	5	5.5	1	7.5	3.5	0.19		
PEC3107M1AQ	BI	1	7	7.5	1	12	1	15		
PEC3112M1Q	BI	1	12	13	1	25	2.5	10		
PEC3202M1Q	BI	1	2.5	2.6	0.5	9	10	20		
PEC3203M1Q	BI	1	3.3	3.5	0.5	9	10	20		
PEC3205M1Q	BI	1	5	5.5	0.5	13	5	20		
PEC1605M1Q	BI	1	5.5	6.8	0.075	12	1	0.6	DFN1006-2L	
PEC4102M1Q	Bi	1	2.5	2.6	0.5	9	30	120		
PEC4103M1Q	Bi	1	3.3	3.5	0.5	9	30	100		
PEC4105M1Q	Bi	1	5	5.5	0.5	13	20	80		

*Under Development

ESD Protection

Part Number	UNI/BI	Ch.	V_{RWM}	V_{BR}	$I_R @ V_{RWM}$	$V_C @ I_{PP}$	I_{PP}	C_J	Package	Circuit Figure
			Min.	Max.	Max.	Max.		Max.		
PJSD12LCFN2	BI	1	12	13	0.1	23	5	20	DFN1006-2L	
PE1605M2AQ	UNI	2	5	5.5	0.05	15	4	0.35	DFN1006-3L	
PE1605M2Q	UNI	2	5	5.5	0.05	10	1	0.35		
PS150M-D62*	Bi	1	24	28	0.5	3.8	10	0.5	DFN1006T-2L	
PS1703-D62*	Bi	1	3.3	5.5	0.5	2.6	12	0.7		
PS1705-D62*	Bi	1	5	6	0.5	3	12	0.7		
PS2403-D63*	Uni	2	3.3	5.5	0.5	4.5	7	0.39	DFN1006T-3L	
PS2405-D63*	Uni	2	5	6	0.5	4.5	7	0.39		
PS2705-D63*	Uni	2	5	6	0.5	3.1	12	0.75		
PE4705L1Q*	Uni	1	5	5.5	3	14.5	100	1300		
PE4707L1Q*	Uni	1	7	7.7	1	16.5	88	960	DFN1610-2L	
PE4709L1Q*	Uni	1	9	9.9	1	20	73	700		
PE4712L1Q*	Uni	1	12	13.2	1	27	58	600		
PE4715L1Q*	Uni	1	15	16.5	1	32	45	480		
PE4720L1Q*	Uni	1	20	22	1	43	34	310		
PE4724L1Q*	Uni	1	24	26.4	1	45	32	280		
PE4736L1Q*	Uni	1	36	39.6	1	75	19	190		
PE1403M4Q	UNI	4	3.3	4	0.05	9	1	0.4	DFN2510-10L	
PE1605M4AQ	UNI	4	5	5.5	0.05	10	1	0.35	DFN2510A-10L	
PJE5UFN10A	UNI	4	5	6	1	13	2.5	0.8		
PE13SD03M4Q	BI	4	3.3	5.5	1	5.5	16	0.32	DFN2510A-10L	
PB4213-DFA*	Uni	4	3.3			10	2.5	0.2		
PB4413-DFA*	Uni	4	3.3	5	1	9	5	0.38	DFN2510A-10L	
PB4415-DFA*	Uni	4	5	6	1	10	4	0.36		
PS4103-DFA*	Uni	4	3.3	7	0.5	8.6	5	0.09	DFN2510A-10L	
PS4105-DFA*	Uni	4	5	8	0.5	8.8	5	0.1		
PS4203-DFA*	Uni	4	3.3	5	1	4.1	5	0.17		
PS4205-DFA*	Uni	4	5	6	1	4.5	5	0.2		
PS4312-DFA*	Uni	4	1.5	5	1	4.1	6	0.29		
PS4313-DFA*	Uni	4	3.3	5	1	4.1	6	0.29		
PS4315-DFA*	Uni	4	5	5.5	1	4.3	6	0.29		
PS4613-DFA*	Uni	4	3.3	5	1	3.5	10	0.65		

*Under Development

ESD Protection

Part Number	UNI/BI	Ch.	V_{RWM}	V_{BR}	$I_R @ V_{RWM}$	$V_C @ I_{PP}$	I_{PP}	C_J	Package	Circuit Figure
			Min.	Max.	Max.	Max.	A	Max.		
PS8A02-DHA*	Uni	8	2.5	5	1	2.5	40	2	DFN3020-10L	
PS8A03-DHA*	Uni	8	3.3	5	1	2.5	40	2		
PE1403S8Q	UNI	8	3.3	4	0.05	13	3	0.4	DFN3810-9L	
PE1605S8Q	UNI	8	5	5.5	0.05	15	4	0.35	DFN3810-9L	
PB8103-DQJ*	Uni	1	3.3	4.5	0.5	16.5	3.5	0.1	DFN5515-18L	
PJSD03TM	UNI	1	3.3	5.4	2.5	10	6	50	SOD-923	
PJSD05TM	UNI	1	5	6.2	1	12	5	35		
PJSD07TM	UNI	1	7	7.5	5	15	4	30		
PJSD12TM	UNI	1	12	13.3	1	23	3	18		
PJSD15TM	UNI	1	15	17	1	30	2	15		
PE4105C1ES	UNI	1	5	6	1	8	1	120	SOD-523	
PE4315ES*	Uni	1	15	16.5	1	28	7.8	65		
PE4320ES*	Uni	1	20	22	1	38	5.8	55		
PE4336ES*	Uni	1	36	39.6	0.05	65	3.3	20		
PE4324ES*	Uni	1	24	26.4	0.05	45	4.8	42		
PEC3202ES	Bi	1	2.5	2.6	0.5	9	10	20		
PE4307ES*	Uni	1	7	7.7	1	16.8	12.9	160		
PE4305ES*	Uni	1	5	6	1	12.4	17.5	200		
PE4309ES*	Uni	1	9	9.9	1	23	9.5	120		
PEC3205ES	Bi	1	5	5.5	0.5	13	5	20		
PJE28VM2TS	UNI	1	28	29	0.5	55	3	25		
PE4312ES*	Uni	1	12	13.2	1	26.5	8.3	90		
PJSD03TS	UNI	1	3.3	4	200	6.5	5	200		
PJSD05TS	UNI	1	5	6	5	9	5	110		
PJSD05TS-02	UNI	1	5	6	1	14	15	160		
PJSD07TS	UNI	1	7	7.5	0.15	22.7	8.8	85		
PJSD08TS	UNI	1	8	8.5	5	13	5	70		
PJSD12TS	UNI	1	12	13.3	5	17	5	60		
PJSD15TS	UNI	1	15	16.6	5	22	5	50		
PJSD24TS	UNI	1	24	26.7	5	32	3	25		
PJSD36TS	UNI	1	36	40	5	55	1	20		
PJSD36W	UNI	1	36	39.9	1	60	1	40		

*Under Development

ESD Protection

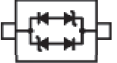
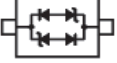
Part Number	UNI/BI	Ch.	V _{RWM}	V _{BR}	I _R @ V _{RWM}	V _C @ I _{PP}	I _{PP}	C _J	Package	Circuit Figure	
			Min.	Max.	Max.	Max.	A	Max.			
PE4315CS*	Uni	1	15	16.5	1	28	7.8	65	SOD-323		
PE4205CS	UNI	1	5	6	7.5	13.5	25	250			
PE4305CS*	Uni	1	5	6	1	12.4	17.5	200			
PE4309CS*	Uni	1	9	9.9	1	3	9.5	120			
PE4307CS*	Uni	1	7	7.7	1	16.8	12.9	160			
PE4207CS	UNI	1	7	7.5	9.5	15	20	200			
PE4209CS	UNI	1	9	9.5	12	20	15	180			
PE4212CS	UNI	1	12	12.5	15.5	24	12	120			
PE4215CS	UNI	1	15	15.5	20	32	9	100			
PE4218CS	UNI	1	18	20	24	34	9	90			
PE4220CS	UNI	1	20	20.5	26	35	8	60			
PE4224CS	UNI	1	24	24.5	31	46	6	55			
PE4236CS	UNI	1	36	36.5	46.5	67	4	40			
PE4312CS*	Uni	1	12	13.2	1	26.5	8.3	90			
PE4320CS*	Uni	1	20	22	1	38	5.8	55			
PE4324CS*	Uni	1	24	26.4	0.05	45	4.8	42			
PE4336CS*	Uni	1	36	39.6	0.05	65	3.3	20			
PE4505CS*	Uni	1	5	6	1	15	31.2	390			
PE4507CS*	Uni	1	7	7.7	1	16.5	28.8	355			
PE4509CS*	Uni	1	9	9.9	0.5	23	20.4	290			
PE4512CS*	Uni	1	12	13.2	0.1	26.5	17.4	195			
PE4515CS*	Uni	1	15	16.5	0.1	35.5	13.2	127			
PE4520CS*	Uni	1	20	22	0.1	40	11.4	105			
PE4524CS*	Uni	1	24	26.4	0.1	55	8.4	82.5			
PE4536CS*	Uni	1	36	39.6	0.1	67.5	6	60			
PJE24HWS	UNI	1	24	26	1	45	14	100			
PJE36HWS	UNI	1	36	40	1	70	8.5	75			
PJE48HWS	UNI	1	48	53.3	1	80	6.5	60			
PJSD05W	UNI	1	5	6	10	9.8	1	360			
PJSD08W	UNI	1	8	8.5	10	13.4	1	180			
PJSD12W	UNI	1	12	13.3	1	19	1	160			
PJSD24W	UNI	1	24	26.6	1	43	1	100			
PJSD15W	UNI	1	15	16.7	1	24	1	150			
PJSD03W	UNI	1	3	4	125	6.5	1	540			
PEC3202CS*	Bi	1	2.5	2.6	0.5	9	10	20			
PEC3203CS*	Bi	1	3.3	2.6	0.5	9	10	20			
PEC3203ES*	Bi	1	3.3	2.6	0.5	9	10	20			
PEC3205CS*	Bi	1	5	5.5	0.5	13	5	20			
PEC4102CS*	Bi	1	2.5	2.6	0.5	9	30	120			
PEC4103CS*	Bi	1	3.3	3.5	0.5	9	30	100			
PEC4105CS*	Bi	1	5	5.5	0.5	13	20	80			
PJEC3V0V1WS	BI	1	3	4.75	20	13	5	1.2			
PJGBLC03C	BI	1	3	4.75	20	7.5	1	3			
PJGBLC05C	BI	1	5	7.03	5	9.8	1	3			
PJGBLC08C	BI	1	8	8.93	1	13.4	1	3			
PJGBLC12C	BI	1	12	13.97	1	19	1	3			
PJGBLC15C	BI	1	15	17.39	1	24	1	3			
PJGBLC24C	BI	1	24	27.27	1	43	1	3			



*Under Development

ESD Protection

Part Number	UNI/BI	Ch.	V_{RWM}	V_{BR}	$I_R @ V_{RWM}$	$V_C @ I_{PP}$	I_{PP}	C_J	Package	Circuit Figure	
			Min.	Max.	Max.	Max.		Max.			Max.
			V	V	μA	V	A	pF			
PJGBLC03	UNI	1	3	4.75	20	7.5	1	3	SOD-323		
PJGBLC05	UNI	1	5	7.03	5	9.8	1	3			
PJGBLC08	UNI	1	8	8.93	1	13.4	1	3			
PJGBLC12	UNI	1	12	13.97	1	19	1	3			
PJGBLC15	UNI	1	15	17.39	1	24	1	3			
PJGBLC24	UNI	1	24	27.27	1	43	1	3			
PJEC2415VM1WS	BI	1	24/15	25.4	0.05	50	3	17			
PJSD05CW	BI	1	5	6.37	5	14.5	24	200			
PJSD12CW	BI	1	12	13.3	1	24	15	100			
PJSD15CW	BI	1	15	16.72	1	29	10	75			
PJSD36CW	BI	1	36	40.57	1	71	3	45			
PJSD24CW	BI	1	24	26.6	1	42	4	50			
PE4312AS*	Uni	1	12	13.2	1	26.5	8.3	90	SOD-123		
PE4307AS*	Uni	1	7	7.7	1	16.8	12.9	160			
PE4305AS*	Uni	1	5	6	1	12.4	17.5	200			
PE4309AS*	Uni	1	9	9.9	1	23	9.5	120			
PE4315AS*	Uni	1	15	16.5	1	28	7.8	65			
PE4320AS*	Uni	1	20	22	1	38	5.8	55			
PE4324AS*	Uni	1	24	26.4	0.05	45	4.8	42			
PE4336AS*	Uni	1	36	39.6	0.05	65	3.3	20			
PE4507AS*	Uni	1	7	7.7	1	16.5	28.8	355			
PE4505AS*	Uni	1	5	6	1	15	31.2	390			
PE4509AS*	Uni	1	9	9.9	0.5	23	20.4	290			
PE4512AS*	Uni	1	12	13.2	0.1	26.5	17.4	195			
PE4515AS*	Uni	1	15	16.5	0.1	35.5	13.2	127			
PE4520AS*	Uni	1	20	22	0.1	40	11.4	105			
PE4524AS*	Uni	1	24	26.4	0.1	55	8.4	82.5			
PE4536AS*	Uni	1	36	39.6	0.1	67.5	6	60			
PE4705AS*	Uni	1	5	5.5	3	14.5	100	1300			
PE4707AS*	Uni	1	7	7.7	1	16.5	88	960			
PE4709AS*	Uni	1	9	9.9	1	20	73	700			
PE4712AS*	Uni	1	12	13.2	1	27	58	600			
PE4715AS*	Uni	1	15	16.5	1	32	45	480			
PE4720AS*	Uni	1	20	22	1	43	34	310			
PE4724AS*	Uni	1	24	26.4	1	45	32	280			
PE4736AS*	Uni	1	36	39.6	1	75	19	190			
PJSD05	UNI	1	5	6	20	16	24	550			
PJSD12	UNI	1	12	13.3	1	23	17	180			
PJSD15	UNI	1	15	16.7	1	28	14	165			
PJSD24	UNI	1	24	26.7	1	37	11	120			
PE4305C2C*	Uni	2	5	6	1	12.4	17.5	200			SOT-323

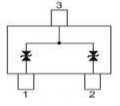

*Under Development

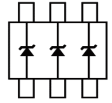
ESD Protection

Part Number	UNI/BI	Ch.	V_{RWM}	V_{BR}	$I_R @ V_{RWM}$	$V_C @ I_{PP}$	I_{PP}	C_J	Package	Circuit Figure	
			Min.	Max.	Max.	Max.		Max.			Max.
PEC4102AS	Bi	1	2.5	2.6	0.5	9	30	120	SOD-123		
PEC4103AS	Bi	1	3.3	3.5	0.5	9	30	100			
PEC4105AS	Bi	1	5	5.5	0.5	13	20	80			
PEC3202C2E	Bi	2	2.5	2.6	0.5	9	10	20	SOT-523		
PEC3203C2E	Bi	2	3.3	2.6	0.5	9	10	20			
PEC3205C2E	Bi	2	5	5.5	0.5	13	5	20			
PEC3202C2C	Bi	2	2.5	2.6	0.5	9	10	20	SOT-323		
PEC3203C2C	Bi	2	3.3	2.6	0.5	9	10	20			
PEC3205C2C	Bi	2	5	5.5	0.5	13	5	20			
PJE5V0U8TB	UNI	2	5	5.8	1	15	4	0.8	SOT-523		
PE4309C2C*	Uni	2	9	9.9	1	23	9.5	120	SOT-323		
PE4312C2C*	Uni	2	12	13.2	1	26.5	8.3	90			
PE4315C2C*	Uni	2	15	16.5	1	28	7.8	65			
PE4322C2C*	Uni	2	22	24.2	0.05	44	5	45			
PE4324C2C*	Uni	2	24	26.4	0.05	45	4.8	42			
PE4336C2C*	Uni	2	36	39.6	0.05	65	3.3	20			
PJSOT05CW	UNI	2	5	6	5	9	7	110			
PJSOT24CW	UNI	2	24	26.7	1	43	4	30			
PE1605C4E6	UNI	4	5.5	6	1	15	4	0.6			SOT-563
PE1605C4C6	UNI	4	5.5	6	1	10	1	0.6		SOT-363	
PE4105C3C6	UNI	3	5	6	1	11	13	120	SOT-363		

*Under Development

ESD Protection

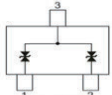
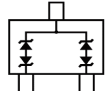
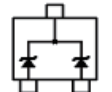
Part Number	UNI/BI	Ch.	V_{RWM}	V_{BR}	$I_R @ V_{RWM}$	$V_C @ I_{PP}$	I_{PP}	C_J	Package	Circuit Figure
			Min.	Max.	Max.	Max.	Max.	A		
			V	V	μA	V	A	pF		
PE1605C2A	UNI	2	5	5.5	0.05	10	1	0.35	SOT-23	
PE3324C2A	UNI	2	24	26.5	1	35	1	30		
PE4105C2A	UNI	2	5	6	1	8	1	120		
PE4136C2A	UNI	2	36	40	1	60	1	100		
PE4305C2A*	Uni	2	5	6	1	12.4	17.5	200		
PE4309C2A*	Uni	2	9	9.9	1	23	9.5	120		
PE4312C2A*	Uni	2	12	13.2	1	26.5	8.3	90		
PE4315C2A*	Uni	2	15	16.5	1	28	7.8	65		
PE4322C2A*	Uni	2	22	24.2	0.05	44	5	45		
PE4324C2A*	Uni	2	24	26.4	0.05	45	4.8	42		
PE4336C2A*	Uni	2	36	39.6	0.05	65	3.3	20		
PE4505C2A*	Uni	2	5	6	1	15	31.2	390		
PE4509C2A*	Uni	2	9	9.9	0.5	23	20.4	290		
PE4512C2A*	Uni	2	12	13.2	0.1	26.5	17.4	195		
PE4515C2A*	Uni	2	15	16.5	0.1	35.5	13.2	127		
PE4524C2A*	Uni	2	24	26.4	0.1	55	8.4	82.5		
PE4536C2A*	Uni	2	36	39.6	0.1	67.5	6	60		
PEC3202C2A*	Bi	2	2.5	2.6	0.5	9	10	20		
PEC3203C2A*	Bi	2	3.3	2.6	0.5	9	10	20		
PEC3205C2A*	Bi	2	5	5.5	0.5	13	5	20		
PEC33712C2A*	BI	2	12/7	13.3	1	25	5	35		
PEC4102C2A*	Bi	2	2.5	2.6	0.5	9	30	120		
PEC4103C2A*	Bi	2	3.3	3.5	0.5	9	30	100		
PEC4105C2A*	Bi	2	5	5.5	0.5	13	20	80		
PJEC12VM1TA	BI	2	12	14	0.05	25	3	10		
PJEC24MTA	BI	2	24	25.4	0.05	50	4	15		
PJMBZ15V	UNI	2	12	14.3	0.1	24	6	80		
PJMBZ27V	UNI	2	22	25.65	0.05	36	4	50		

*Under Development

ESD Protection

Part Number	UNI/BI	Ch.	V_{RWM}	V_{BR}	$I_R @ V_{RWM}$	$V_C @ I_{PP}$	I_{PP}	C_J	Package	Circuit Figure
			Min.	Max.	Max.	Max.	A	Max.		
PJSOT03	UNI	1	3	4	125	6.5	43	850	SOT-23	
PJSOT05	UNI	1	5	6	20	9.8	42	550		
PJSOT05C-02	UNI	2	5	6	20	11.2	13	120		
PJSOT05C-03	UNI	2	5	6	20	12.6	21	250		
PJSOT08	UNI	1	8	8.5	10	13.4	34	360	SOT-23	
PJSOT12	UNI	1	12	13.3	2	19	21	200		
PJSOT15	UNI	1	15	16.7	1	24	17	170		
PJSOT24	UNI	1	24	26.7	1	43	12	150		
PJSOT36	UNI	1	36	40	1	51	9	80		
PJSOT24C-02	UNI	2	24	26.7	20	47.2	3	30		
PJSOT24C-03	UNI	2	24	26.7	20	45.3	6	55		
PE1605C4A6	UNI	4	5.5	6	1	10	1	0.6	SOT-23 6L	
PJ4L40W6	UNI	4	25	30	2	-	-	19	SOT-23 6L	
PB4935-S26*	Uni	5	5	6	1	10	10	1	SOT-23 6L-1	
PB5615-S26*	Uni	5	5	6	1	10.5	5.5	0.4		
PB5635-S26*	Uni	5	5	6	1	10	6	0.65		
PB5935-S26*	Uni	5	5	6	1	4	7	0.9		
PE21SD05C4A6	UNI	4+1	3.3/5	6	1	2.3	5	1.8	SOT-23 6L-1	
PS4A12-S26*	Uni	5	2.5	5	1	3.2	20	1.4	SOT-23 6L-1	
PS5915-S26*	Uni	5	5	6.5	1	4	10	0.9		

*Under Development

Transient Voltage Suppressors

Part Number		P _D	V _{RWM}	V _{BR} @ I _T (V)		I _T	I _R @ V _{RWM} (μA)		V _C @ I _{PP} Max.	I _{PP}	Package
UNI	BI	W	V	Min.	Max.	mA	UNI	BI	V	A	
P1CH3.3A	-	150	3.3	5.2	6	10	50	-	8.5	17.6	SOD-323HE
P1CH5.0A	-	150	5	6.4	7	10	5	-	9.2	16.3	
P1CH6.0A	-	150	6	6.67	7.37	10	5	-	10.3	14.5	
P1CH6.5A	-	150	6.5	7.22	7.98	10	4	-	11.2	13.4	
P1CH7.0A	-	150	7	7.78	8.6	10	4	-	12	12.5	
P1CH7.5A	-	150	7.5	8.33	9.21	1	3	-	12.9	11.6	
P1CH8.0A	-	150	8	8.89	9.83	1	2	-	13.6	11	
P1CH8.5A	-	150	8.5	9.44	10.4	1	2	-	14.4	10.4	
P1CH9.0A	-	150	9	10	11.1	1	1	-	15.4	9.7	
P1CH10A	-	150	10	11.1	12.3	1	1	-	17	8.8	
P1CH11A	-	150	11	12.2	13.5	1	1	-	18.2	8.2	
P1CH12A	-	150	12	13.3	14.7	1	1	-	19.9	7.5	
P1CH13A	-	150	13	14.4	15.9	1	0.5	-	21.5	7	
P1CH14A	-	150	14	15.6	17.2	1	0.5	-	23.2	6.5	
P1CH15A	-	150	15	16.7	18.5	1	0.5	-	24.4	6.1	
P1CH16A	-	150	16	17.8	19.7	1	0.5	-	26	5.8	
P1CH17A	-	150	17	18.9	20.9	1	0.5	-	27.6	5.3	
P1CH18A	-	150	18	20	22.1	1	0.5	-	29.2	5.1	
P1CH20A	-	150	20	22	24.5	1	0.5	-	32.4	4.6	
P1CH22A	-	150	22	24.4	26.9	1	0.5	-	35.5	4.2	
P1CH24A	-	150	24	26.7	29.5	1	0.5	-	38.9	3.9	
P1CH26A	-	150	26	28.9	31.9	1	0.5	-	42.1	3.6	
P1CH28A	-	150	28	31.1	34.4	1	0.5	-	45.4	3.3	
P1CH30A	-	150	30	33.3	36.8	1	0.5	-	48.4	3.1	
P1CH33A	-	150	33	36.7	40.6	1	0.5	-	53.3	2.8	
P1CH36A	-	150	36	40	44.2	1	0.5	-	58.1	2.6	
P2AL3.3A	-	200	3.3	5.2	6	10	50	-	8.5	23.5	SOD-123FL
P2AL5.0A	-	200	5	6.4	7	10	25	-	9.2	21.7	
P2AL6.0A	-	200	6	6.67	7.37	10	25	-	10.3	19.4	
P2AL6.5A	-	200	6.5	7.22	b	10	20	-	11.2	17.9	
P2AL7.0A	-	200	7	7.78	8.6	10	20	-	12	16.7	
P2AL7.5A	-	200	7.5	8.33	9.21	1	15	-	12.9	15.5	
P2AL8.0A	-	200	8	8.89	9.83	1	2	-	13.6	14.7	
P2AL8.5A	-	200	8.5	9.44	10.4	1	2	-	14.4	13.9	
P2AL9.0A	-	200	9	10	11.1	1	0.5	-	15.4	13	
P2AL10A	-	200	10	11.1	12.3	1	0.5	-	17	11.8	
P2AL11A	-	200	11	12.2	13.5	1	0.5	-	18.2	11	
P2AL12A	-	200	12	13.3	14.7	1	0.5	-	19.9	10.1	
P2AL13A	-	200	13	14.4	15.9	1	0.1	-	21.5	9.3	
P2AL14A	-	200	14	15.6	17.2	1	0.1	-	23.2	8.6	
P2AL15A	-	200	15	16.7	18.5	1	0.1	-	24.4	8.2	
P2AL16A	-	200	16	17.8	19.7	1	0.1	-	26	7.7	
P2AL17A	-	200	17	18.9	20.9	1	0.1	-	27.6	7.2	
P2AL18A	-	200	18	20	22.1	1	0.1	-	29.2	6.8	
P2AL20A	-	200	20	22	24.5	1	0.1	-	32.4	6.2	
P2AL22A	-	200	22	24.4	26.9	1	0.1	-	35.5	5.6	
P2AL24A	-	200	24	26.7	29.5	1	0.1	-	38.9	5.1	
P2AL26A	-	200	26	28.9	31.9	1	0.1	-	42.1	4.8	
P2AL28A	-	200	28	31.1	34.4	1	0.1	-	45.4	4.4	
P2AL30A	-	200	30	33.3	36.8	1	0.1	-	48.4	4.1	
P2AL33A	-	200	33	36.7	40.6	1	0.1	-	53.3	3.8	
P2AL36A	-	200	36	40	44.2	1	0.1	-	58.1	3.4	

Transient Voltage Suppressors

Part Number		P _D	V _{RWM}	V _{BR} @ I _T (V)		I _T	I _R @ V _{RWM} (μA)		V _C @ I _{PP} Max.	I _{PP}	Package
UNI	BI	W	V	Min.	Max.	mA	UNI	BI	V	A	
P2AL40A	-	200	40	44.4	49.1	1	0.1	-	64.5	3.1	SOD-123FL
P4FL3.3A	-	400	3.3	5.2	6	10	100	-	8.5	47	
P4FL5.0A	-	400	5	6.4	7	10	50	-	9.2	43.5	
P4FL6.0A	-	400	6	6.67	7.37	10	50	-	10.3	38.8	
P4FL6.5A	-	400	6.5	7.22	7.98	10	40	-	11.2	35.7	
P4FL7.0A	-	400	7	7.78	8.6	10	40	-	12	33.3	
P4FL7.5A	-	400	7.5	8.33	9.21	1	30	-	12.9	31	
P4FL8.0A	-	400	8	8.89	9.83	1	5	-	13.6	29.4	
P4FL8.5A	-	400	8.5	9.44	10.4	1	5	-	14.4	27.8	
P4FL9.0A	-	400	9	10	11.1	1	0.5	-	15.4	26	
P4FL10A	-	400	10	11.1	12.3	1	0.5	-	17	23.5	
P4FL11A	-	400	11	12.2	13.5	1	0.5	-	18.2	22	
P4FL12A	-	400	12	13.3	14.7	1	0.5	-	19.9	20.1	
P4FL13A	-	400	13	14.4	15.9	1	0.1	-	21.5	18.6	
P4FL14A	-	400	14	15.6	17.2	1	0.1	-	23.2	17.2	
P4FL15A	-	400	15	16.7	18.5	1	0.1	-	24.4	16.4	
P4FL16A	-	400	16	17.8	19.7	1	0.1	-	26	15.4	
P4FL17A	-	400	17	18.9	20.9	1	0.1	-	27.6	14.5	
P4FL18A	-	400	18	20	22.1	1	0.1	-	29.2	13.7	
P4FL20A	-	400	20	22	24.5	1	0.1	-	32.4	12.3	
P4FL22A	-	400	22	24.4	26.9	1	0.1	-	35.5	11.3	
P4FL24A	-	400	24	26.7	29.5	1	0.1	-	38.9	10.3	
P4FL26A	-	400	26	28.9	31.9	1	0.1	-	42.1	9.5	
P4FL28A	-	400	28	31.1	34.4	1	0.1	-	45.4	8.8	
P4FL30A	-	400	30	33.3	36.8	1	0.1	-	48.4	8.3	
P4FL33A	-	400	33	36.7	40.6	1	0.1	-	53.3	7.5	
P4FL36A	-	400	36	40	44.2	1	0.1	-	58.1	6.9	
P4FL40A	-	400	40	44.4	49.1	1	0.1	-	64.5	6.2	
P4FL43A	-	400	43	47.8	52.8	1	0.1	-	69.4	5.8	
P4FL45A	-	400	45	50	55.3	1	0.1	-	72.2	5.5	
P4FL48A	-	400	48	53.3	58.9	1	0.1	-	77.4	5.2	
P4FL51A	-	400	51	56.7	62.7	1	0.1	-	82.4	4.9	
P4FL54A	-	400	54	60	66.3	1	0.1	-	87.1	4.6	
P4FL58A	-	400	58	64.4	71.2	1	0.1	-	93.6	4.3	
P4FL60A	-	400	60	66.7	73.7	1	0.1	-	96.8	4.1	
P4FL64A	-	400	64	71.1	78.6	1	0.1	-	103	3.9	
P4HE3.3A	-	400	3.3	5.2	6	10	100	-	8.5	47	SOD-123HE
P4HE5.0A	-	400	5	6.4	7	10	50	-	9.2	43.5	
P4HE6.0A	-	400	6	6.67	7.37	10	50	-	10.3	38.8	
P4HE6.5A	-	400	6.5	7.22	7.98	10	40	-	11.2	35.7	
P4HE7.0A	-	400	7	7.78	8.6	10	40	-	12	33.3	
P4HE7.5A	-	400	7.5	8.33	9.21	1	30	-	12.9	31	
P4HE8.0A	-	400	8	8.89	9.83	1	5	-	13.6	29.4	
P4HE8.5A	-	400	8.5	9.44	10.4	1	5	-	14.4	27.8	
P4HE9.0A	-	400	9	10	11.1	1	0.5	-	15.4	26	
P4HE10A	-	400	10	11.1	12.3	1	0.5	-	17	23.5	
P4HE11A	-	400	11	12.2	13.5	1	0.5	-	18.2	22	
P4HE12A	-	400	12	13.3	14.7	1	0.5	-	19.9	20.1	
P4HE13A	-	400	13	14.4	15.9	1	0.1	-	21.5	18.6	
P4HE14A	-	400	14	15.6	17.2	1	0.1	-	23.2	17.2	
P4HE15A	-	400	15	16.7	18.5	1	0.1	-	24.4	16.4	
P4HE16A	-	400	16	17.8	19.7	1	0.1	-	26	15.4	
P4HE17A	-	400	17	18.9	20.9	1	0.1	-	27.6	14.5	
P4HE18A	-	400	18	20	22.1	1	0.1	-	29.2	13.7	SOD-123HE
P4HE20A	-	400	20	22.2	24.5	1	0.1	-	32.4	12.3	
P4HE22A	-	400	22	24.4	26.9	1	0.1	-	35.5	11.3	
P4HE24A	-	400	24	26.7	29.5	1	0.1	-	38.9	10.3	
P4HE26A	-	400	26	28.9	31.9	1	0.1	-	42.1	9.5	
P4HE28A	-	400	28	31.1	34.4	1	0.1	-	45.4	8.8	
P4HE30A	-	400	30	33.3	36.8	1	0.1	-	48.4	8.3	

Transient Voltage Suppressors

Part Number		P _D	V _{RWM}	V _{BR} @ I _T (V)		I _T mA	I _R @ V _{RWM} (μA)		V _C @ I _{PP} Max.	I _{PP} A	Package
UNI	BI			W	V		Min.	Max.			
P4HE33A	-	400	33	36.7	40.6	1	0.1	-	53.3	7.5	SOD-123HE
P4HE36A	-	400	36	40	44.2	1	0.1	-	58.1	6.9	
P4HE40A	-	400	40	44.4	49.1	1	0.1	-	64.5	6.2	
P4HE43A	-	400	43	47.8	52.8	1	0.1	-	69.4	5.8	
P4HE45A	-	400	45	50	55.3	1	0.1	-	72.7	5.5	
P4HE48A	-	400	48	53.3	58.9	1	0.1	-	77.4	5.2	
P4HE51A	-	400	51	56.7	62.7	1	0.1	-	82.4	4.9	
P4HE54A	-	400	54	60	66.3	1	0.1	-	87.1	4.6	
P4HE58A	-	400	58	64.4	71.2	1	0.1	-	93.6	4.3	
P4HE60A	-	400	60	66.7	73.7	1	0.1	-	96.8	4.1	
P4HE64A	-	400	64	71.1	78.6	1	0.1	-	103	3.9	
P6AFC3.3A	-	600	3.3	5.2	6	10	100	-	8	75	SMAF-C
P6AFC5.0A	-	600	5	6.4	7	10	50	-	9.2	65.2	
P6AFC6.0A	-	600	6	6.67	7.37	10	50	-	10.3	58.3	
P6AFC6.5A	-	600	6.5	7.22	7.98	10	40	-	11.2	53.6	
P6AFC7.0A	-	600	7	7.78	8.6	10	40	-	12	50	
P6AFC7.5A	-	600	7.5	8.33	9.21	1	30	-	12.9	46.5	
P6AFC8.0A	-	600	8	8.89	9.83	1	5	-	13.6	44.1	
P6AFC8.5A	-	600	8.5	9.44	10.4	1	5	-	14.4	41.7	
P6AFC9.0A	-	600	9	10	11.1	1	0.5	-	15.4	39	
P6AFC10A	-	600	10	11.1	12.3	1	0.5	-	17	35.3	
P6AFC11A	-	600	11	12.2	13.5	1	0.5	-	18.2	33	
P6AFC12A	-	600	12	13.3	14.7	1	0.5	-	19.9	30.2	
P6AFC13A	-	600	13	14.4	15.9	1	0.1	-	21.5	27.9	
P6AFC14A	-	600	14	15.6	17.2	1	0.1	-	23.2	25.9	
P6AFC15A	-	600	15	16.7	18.5	1	0.1	-	24.4	24.6	
P6AFC16A	-	600	16	17.8	19.7	1	0.1	-	26	23.1	
P6AFC17A	-	600	17	18.9	20.9	1	0.1	-	27.6	21.7	
P6AFC18A	-	600	18	20	22.1	1	0.1	-	29.2	20.5	
P6AFC20A	-	600	20	22.2	24.5	1	0.1	-	32.4	18.5	
P6AFC22A	-	600	22	24.4	26.9	1	0.1	-	35.5	16.9	
P6AFC24A	-	600	24	26.7	29.5	1	0.1	-	38.9	15.4	
P6AFC26A	-	600	26	28.9	31.9	1	0.1	-	42.1	14.3	
P6AFC28A	-	600	28	31.1	34.4	1	0.1	-	45.4	13.2	
P6AFC30A	-	600	30	33.3	36.8	1	0.1	-	48.4	12.4	
P6AFC33A	-	600	33	36.7	40.6	1	0.1	-	53.3	11.3	
P6AFC36A	-	600	36	40	44.2	1	0.1	-	58.1	10.3	
P6AFC40A	-	600	40	44.4	49.1	1	0.1	-	64.5	9.3	
P6AFC43A	-	600	43	47.8	52.8	1	0.1	-	69.4	8.6	
P6AFC45A	-	600	45	50	55.3	1	0.1	-	72.7	8.3	
P6AFC48A	-	600	48	53.3	58.9	1	0.1	-	77.4	7.8	
P6AFC51A	-	600	51	56.7	62.7	1	0.1	-	82.4	7.3	
P6AFC54A	-	600	54	60	66.3	1	0.1	-	87.1	6.9	
P6AFC58A	-	600	58	64.4	71.2	1	0.1	-	93.6	6.4	
P6AFC60A	-	600	60	66.7	73.7	1	0.1	-	96.8	6.2	
P6AFC64A	-	600	64	71.1	78.6	1	0.1	-	103	5.8	

Transient Voltage Suppressors

Part Number		P _D	V _{RWM}	V _{BR} @ I _T (V)		I _T	I _R @ V _{RWM} (μA)		V _C @ I _{PP} Max.	I _{PP}	Package
UNI	BI	W	V	Min.	Max.	mA	UNI	BI	V	A	
P4AFC3.3AS	-	400	3.3	5.2	6	10	600	-	8.5	47	SMAF-C
P4AFC5.0AS	-	400	5	6.4	7	10	400	-	9.2	43.5	
P4AFC6.0AS	-	400	6	6.67	7.37	10	400	-	10.3	38.8	
P4AFC6.5AS	-	400	6.5	7.22	7.89	10	250	-	11.2	35.7	
P4AFC7.0AS	-	400	7	7.78	8.6	10	100	-	12	33.3	
P4AFC8.0AS	-	400	8	8.89	9.83	1	25	-	13.6	29.4	
P4AFC8.5AS	-	400	8.5	9.44	10.82	1	10	-	14.4	27.7	
P4AFC9.0AS	-	400	9	10	11.5	1	5	-	15.4	26	
P4AFC10AS	-	400	10	11.1	12.8	1	5	-	17	23.5	
P4AFC11AS	-	400	11	12.2	14	1	1	-	18.2	22	
P4AFC12AS	-	400	12	13.3	15.3	1	1	-	19.9	20.1	
P4AFC13AS	-	400	13	14.4	16.5	1	1	-	21.5	18.6	
P4AFC14AS	-	400	14	15.6	17.9	1	1	-	23.2	17.2	
P4AFC15AS	-	400	15	16.7	19.2	1	1	-	24.4	16.4	
P4AFC16AS	-	400	16	17.8	20.5	1	1	-	26	15.3	
P4AFC17AS	-	400	17	18.9	21.7	1	1	-	27.6	14.5	
P4AFC18AS	-	400	18	20	23.3	1	1	-	29.2	13.7	
P4AFC20AS	-	400	20	22.2	25.5	1	1	-	32.4	12.3	
P4AFC22AS	-	400	22	24.4	28	1	1	-	35.5	11.2	
P4AFC24AS	-	400	24	26.7	30.7	1	1	-	38.9	10.3	
P4AFC26AS	-	400	26	28.9	33.2	1	1	-	42.1	9.5	
P4AFC28AS	-	400	28	31.1	35.8	1	1	-	45.4	8.8	
P4AFC30AS	-	400	30	33.3	38.3	1	1	-	48.4	8.3	
P4AFC33AS	-	400	33	36.7	42.2	1	1	-	53.3	7.5	
P4AFC36AS	-	400	36	40	46	1	1	-	58.1	6.9	
P4AFC40AS	-	400	40	44.4	51.1	1	1	-	64.5	6.2	
P4AFC43AS	-	400	43	47.8	54.9	1	1	-	69.4	5.7	
P4AFC45AS	-	400	45	50	57.5	1	1	-	72.7	5.5	
P4AFC48AS	-	400	48	53.3	61.3	1	1	-	77.4	5.2	
P4AFC51AS	-	400	51	56.7	65.2	1	1	-	82.4	4.9	
P4AFC54AS	-	400	54	60	69	1	1	-	87.1	4.6	
P4AFC58AS	-	400	58	64.4	74.1	1	1	-	93.6	4.3	
P4AFC60AS	-	400	60	66.7	76.7	1	1	-	96.8	4.1	
P4AFC64AS	-	400	64	71.1	81.8	1	1	-	103	3.9	
P4AFC70AS	-	400	70	77.8	89.5	1	1	-	113	3.5	
P4AFC75AS	-	400	75	83.3	95.8	1	1	-	121	3.3	
P4AFC78AS	-	400	78	86.7	99.7	1	1	-	126	3.2	
P4AFC85AS	-	400	85	94.4	108.2	1	1	-	137	2.9	
P4AFC90AS	-	400	90	100	115.5	1	1	-	146	2.7	
P4AFC100AS	-	400	100	111	128	1	1	-	162	2.5	
P4AFC110AS	-	400	110	122	140.5	1	1	-	177	2.3	
P4AFC120AS	-	400	120	133	153	1	1	-	193	2	
P4AFC130AS	-	400	130	144	165.5	1	1	-	209	1.9	
P4AFC150AS	-	400	150	167	192.5	1	1	-	243	1.6	
P4AFC160AS	-	400	160	178	205	1	1	-	259	1.5	
P4AFC170AS	-	400	170	189	217.5	1	1	-	275	1.4	
P4AFC180AS	-	400	180	198	221	1	1	-	291	1.4	
P4AFC190AS	-	400	190	209	233	1	1	-	307	1.3	
P4AFC200AS	-	400	200	220	246	1	1	-	324	1.2	
P4AFC220AS	-	400	220	246	272	1	1	-	356	1.1	
P4SMA10AS	P4SMA10CAS	400	8.55	9.5	10.5	1	20	20	14.5	29	SMA
P4SMA11AS	P4SMA11CAS	400	9.4	10.5	11.6	1	10	10	15.6	27	
P4SMA12AS	P4SMA12CAS	400	10.2	11.4	12.6	1	1	1	16.7	25	
P4SMA13AS	P4SMA13CAS	400	11.1	12.4	13.7	1	1	1	18.2	23	
P4SMA15AS	P4SMA15CAS	400	12.8	14.3	15.8	1	1	1	21.2	20	
P4SMA16AS	P4SMA16CAS	400	13.6	15.2	16.8	1	1	1	22.5	19	
P4SMA18AS	P4SMA18CAS	400	15.3	17.1	18.9	1	1	1	25.2	17	
P4SMA20AS	P4SMA20CAS	400	17.1	19	21	1	1	1	27.7	15	

Transient Voltage Suppressors

Part Number		P _D	V _{RWM}	V _{BR} @ I _T (V)		I _T mA	I _R @ V _{RWM} (μA)		V _C @ I _{PP} Max. V	I _{PP} A	Package
UNI	BI			W	V		Min.	Max.			
P4SMA22AS	P4SMA22CAS	400	18.8	20.9	23.1	1	1	1	30.6	14	SMA
P4SMA24AS	P4SMA24CAS	400	20.5	22.8	25.2	1	1	1	33.2	13	
P4SMA27AS	P4SMA27CAS	400	23.1	25.7	28.4	1	1	1	37.5	11.2	
P4SMA30AS	P4SMA30CAS	400	25.6	28.5	31.5	1	1	1	41.4	10	
P4SMA33AS	P4SMA33CAS	400	28.2	31.4	34.7	1	1	1	45.7	9	
P4SMA36AS	P4SMA36CAS	400	30.8	34.2	37.8	1	1	1	49.9	8.4	
P4SMA39AS	P4SMA39CAS	400	33.3	37.1	41	1	1	1	53.9	7.8	
P4SMA43AS	P4SMA43CAS	400	36.8	40.9	45.2	1	1	1	59.3	7.1	
P4SMA47AS	P4SMA47CAS	400	40.2	44.7	49.4	1	1	1	64.8	5	
P4SMA51AS	P4SMA51CAS	400	43.6	48.5	53.6	1	1	1	70.1	6	
P4SMA56AS	P4SMA56CAS	400	47.8	53.2	58.8	1	1	1	77	5.5	

Transient Voltage Suppressors

Part Number		P _D	V _{RWM}	V _{BR} @ I _T (V)		I _T	I _R @ V _{RWM} (μA)		V _C @ I _{PP} Max.	I _{PP}	Package
UNI	BI	W	V	Min.	Max.	mA	UNI	BI	V	A	
P4SMA62AS	P4SMA62CAS	400	53	58.9	65.1	1	1	1	85	5	
P4SMA68AS	P4SMA68CAS	400	58.1	64.6	71.4	1	1	1	92	4.6	
P4SMA75AS	P4SMA75CAS	400	64.1	71.3	78.8	1	1	1	103	4.1	
P4SMA82AS	P4SMA82CAS	400	70.1	77.9	86.1	1	1	1	113	3.7	
P4SMA91AS	P4SMA91CAS	400	77.8	86.5	95.5	1	1	1	125	3.4	
P4SMA100AS	P4SMA100CAS	400	85.5	95	105	1	1	1	137	3.1	
P4SMA110AS	P4SMA110CAS	400	94	105	116	1	1	1	152	2.8	
P4SMA120AS	P4SMA120CAS	400	102	114	126	1	1	1	165	2.5	
P4SMA130AS	P4SMA130CAS	400	111	124	137	1	1	1	179	2.3	
P4SMA150AS	P4SMA150CAS	400	128	143	158	1	1	1	207	2	
P4SMA160AS	P4SMA160CAS	400	136	152	168	1	1	1	219	1.9	
P4SMA170AS	P4SMA170CAS	400	145	162	179	1	1	1	234	1.8	
P4SMA180AS	P4SMA180CAS	400	154	171	189	1	1	1	246	1.7	
P4SMA200AS	P4SMA200CAS	400	171	190	210	1	1	1	274	1.5	
P4SMA220AS	P4SMA220CAS	400	185	209	231	1	1	1	328	1.2	
P4SMA250AS	P4SMA250CAS	400	214	237	263	1	1	1	344	1.2	
P4SMAJ8.5AS	P4SMAJ8.5CAS	400	8.5	9.44	10.4	1	10	20	14.4	27.7	
P4SMAJ9.0AS	P4SMAJ9.0CAS	400	9	10	11.1	1	5	5	15.4	26	
P4SMAJ10AS	P4SMAJ10CAS	400	10	11.1	12.3	1	5	5	17	23.5	
P4SMAJ11AS	P4SMAJ11CAS	400	11	12.2	13.5	1	1	1	18.2	22	
P4SMAJ12AS	P4SMAJ12CAS	400	12	13.3	14.7	1	1	1	19.9	20.1	
P4SMAJ13AS	P4SMAJ13CAS	400	13	14.4	15.9	1	1	1	21.5	18.6	
P4SMAJ14AS	P4SMAJ14CAS	400	14	15.6	17.2	1	1	1	23.2	17.2	
P4SMAJ15AS	P4SMAJ15CAS	400	15	16.7	18.5	1	1	1	24.4	16.4	
P4SMAJ16AS	P4SMAJ16CAS	400	16	17.8	19.7	1	1	1	26	15.3	
P4SMAJ17AS	P4SMAJ17CAS	400	17	18.9	20.9	1	1	1	27.6	14.5	
P4SMAJ18AS	P4SMAJ18CAS	400	18	20	22.1	1	1	1	29.2	13.7	SMA
P4SMAJ20AS	P4SMAJ20CAS	400	20	22.2	24.5	1	1	1	32.4	12.3	
P4SMAJ22AS	P4SMAJ22CAS	400	22	24.4	26.9	1	1	1	35.5	11.2	
P4SMAJ24AS	P4SMAJ24CAS	400	24	26.7	29.5	1	1	1	38.9	10.3	
P4SMAJ26AS	P4SMAJ26CAS	400	26	28.9	31.9	1	1	1	42.1	9.5	
P4SMAJ28AS	P4SMAJ28CAS	400	28	31.1	34.4	1	1	1	45.4	8.8	
P4SMAJ30AS	P4SMAJ30CAS	400	30	33.3	36.8	1	1	1	48.4	8.3	
P4SMAJ33AS	P4SMAJ33CAS	400	33	36.7	40.6	1	1	1	53.3	7.5	
P4SMAJ36AS	P4SMAJ36CAS	400	36	40	44.2	1	1	1	58.1	6.9	
P4SMAJ40AS	P4SMAJ40CAS	400	40	44.4	49.1	1	1	1	64.5	6.2	
P4SMAJ43AS	P4SMAJ43CAS	400	43	47.8	52.8	1	1	1	69.4	5.7	
P4SMAJ45AS	P4SMAJ45CAS	400	45	50	55.3	1	1	1	72.7	5.5	
P4SMAJ48AS	P4SMAJ48CAS	400	48	53.3	58.9	1	1	1	77.4	5.2	
P4SMAJ51AS	P4SMAJ51CAS	400	51	56.7	62.7	1	1	1	82.4	4.9	
P4SMAJ54AS	P4SMAJ54CAS	400	54	60	66.3	1	1	1	87.1	4.6	
P4SMAJ58AS	P4SMAJ58CAS	400	58	64.4	71.2	1	1	1	93.6	4.3	
P4SMAJ60AS	P4SMAJ60CAS	400	60	66.7	73.7	1	1	1	96.8	4.1	
P4SMAJ64AS	P4SMAJ64CAS	400	64	71.1	78.6	1	1	1	103	3.9	
P4SMAJ70AS	P4SMAJ70CAS	400	70	77.8	86	1	1	1	113	3.5	
P4SMAJ75AS	P4SMAJ75CAS	400	75	83.3	92.1	1	1	1	121	3.3	
P4SMAJ78AS	P4SMAJ78CAS	400	78	86.7	95.8	1	1	1	126	3.2	
P4SMAJ85AS	P4SMAJ85CAS	400	85	94.4	104	1	1	1	137	2.9	
P4SMAJ90AS	P4SMAJ90CAS	400	90	100	111	1	1	1	146	2.7	
P4SMAJ100AS	P4SMAJ100CAS	400	100	111	123	1	1	1	162	2.5	
P4SMAJ110AS	P4SMAJ110CAS	400	110	122	135	1	1	1	177	2.3	
P4SMAJ120AS	P4SMAJ120CAS	400	120	133	147	1	1	1	193	2	

Transient Voltage Suppressors

Part Number		P _D	V _{RWM}	V _{BR} @ I _T (V)		I _T mA	I _R @ V _{RWM} (μA)		V _C @ I _{PP} Max.	I _{PP} A	Package
UNI	BI			W	V		Min.	Max.			
P4SMAJ130AS	P4SMAJ130CAS	400	130	144	159	1	1	1	209	1.9	SMA
P4SMAJ150AS	P4SMAJ150CAS	400	150	167	185	1	1	1	243	1.6	
P4SMAJ160AS	P4SMAJ160CAS	400	160	178	197	1	1	1	259	1.5	
P4SMAJ170AS	P4SMAJ170CAS	400	170	189	209	1	1	1	275	1.4	
P4SMAJ180AS	P4SMAJ180CAS	400	180	198	222	1	1	1	292	1.3	
P4SMAJ190AS	P4SMAJ190CAS	400	190	209	243.2	1	1	1	308	1.3	
P4SMAJ200AS	P4SMAJ200CAS	400	200	220	247	1	1	1	324	1.2	
P4SMAJ210AS	P4SMAJ210CAS	400	210	231	268.8	1	1	1	340	1.2	
P4SMAJ220AS	P4SMAJ220CAS	400	220	242	272	1	1	1	356	1.1	
P6SMB10AS	P6SMB10CAS	600	8.55	9.5	10.5	1	10	20	14.5	41	
P6SMB11AS	P6SMB11CAS	600	9.4	10.5	11.6	1	5	10	15.6	38	
P6SMB12AS	P6SMB12CAS	600	10.2	11.4	12.6	1	5	5	16.7	36	
P6SMB13AS	P6SMB13CAS	600	11.1	12.4	13.7	1	1	1	18.2	33	
P6SMB15AS	P6SMB15CAS	600	12.8	14.3	15.8	1	1	1	21.2	28	
P6SMB16AS	P6SMB16CAS	600	13.6	15.2	16.8	1	1	1	22.5	27	
P6SMB18AS	P6SMB18CAS	600	15.3	17.1	18.9	1	1	1	25.2	24	
P6SMB20AS	P6SMB20CAS	600	17.1	19	21	1	1	1	27.7	22	
P6SMB22AS	P6SMB22CAS	600	18.8	20.9	23.1	1	1	1	30.6	20	
P6SMB24AS	P6SMB24CAS	600	20.5	22.8	25.2	1	1	1	33.2	18	
P6SMB27AS	P6SMB27CAS	600	23.1	25.7	28.4	1	1	1	37.5	16	
P6SMB30AS	P6SMB30CAS	600	25.6	28.5	31.5	1	1	1	41.4	14.4	
P6SMB33AS	P6SMB33CAS	600	28.2	31.4	34.7	1	1	1	45.7	13.2	
P6SMB36AS	P6SMB36CAS	600	30.8	34.2	37.8	1	1	1	49.9	12	
P6SMB39AS	P6SMB39CAS	600	33.3	37.1	41	1	1	1	53.9	11.2	
P6SMB43AS	P6SMB43CAS	600	36.8	40.9	45.2	1	1	1	59.3	10.1	
P6SMB47AS	P6SMB47CAS	600	40.2	44.7	49.4	1	1	1	64.8	9.3	
P6SMB51AS	P6SMB51CAS	600	43.6	48.5	53.6	1	1	1	70.1	8.6	
P6SMB56AS	P6SMB56CAS	600	47.8	53.2	58.8	1	1	1	77	7.8	
P6SMB62AS	P6SMB62CAS	600	53	58.9	65.1	1	1	1	85	7.1	
P6SMB68AS	P6SMB68CAS	600	58.1	64.6	71.4	1	1	1	92	6.5	
P6SMB75AS	P6SMB75CAS	600	64.1	71.3	78.8	1	1	1	103	5.8	
P6SMB82AS	P6SMB82CAS	600	70.1	77.9	86.1	1	1	1	113	5.3	
P6SMB91AS	P6SMB91CAS	600	77.8	86.5	95.5	1	1	1	125	4.8	
P6SMB100AS	P6SMB100CAS	600	85.5	95	105	1	1	1	137	4.4	
P6SMB110AS	P6SMB110CAS	600	94	105	116	1	1	1	152	4	
P6SMB120AS	P6SMB120CAS	600	102	114	126	1	1	1	165	3.6	
P6SMB130AS	P6SMB130CAS	600	111	124	137	1	1	1	179	3.3	
P6SMB150AS	P6SMB150CAS	600	128	143	158	1	1	1	207	2.9	
P6SMB160AS	P6SMB160CAS	600	136	152	168	1	1	1	219	2.7	
P6SMB170AS	P6SMB170CAS	600	145	162	179	1	1	1	234	2.6	
P6SMB180AS	P6SMB180CAS	600	154	171	189	1	1	1	246	2.4	
P6SMB200AS	P6SMB200CAS	600	171	190	210	1	1	1	274	2.2	
P6SMB220AS	P6SMB220CAS	600	185	209	231	1	1	1	328	1.9	
P6SMB250AS	P6SMB250CAS	600	214	237	263	1	1	1	344	1.8	
P6SMBJ8.5AS	P6SMBJ8.5CAS	600	8.5	9.44	10.4	1	10	10	14.4	41.7	
P6SMBJ9.0AS	P6SMBJ9.0CAS	600	9	10	11.1	1	5	5	15.4	39	
P6SMBJ10AS	P6SMBJ10CAS	600	10	11.1	12.3	1	5	5	17	35.3	
P6SMBJ11AS	P6SMBJ11CAS	600	11	12.2	13.5	1	5	1	18.2	33	
P6SMBJ12AS	P6SMBJ12CAS	600	12	13.3	14.7	1	1	1	19.9	30.2	
P6SMBJ13AS	P6SMBJ13CAS	600	13	14.4	15.9	1	1	1	21.5	28	
P6SMBJ14AS	P6SMBJ14CAS	600	14	15.6	17.2	1	1	1	23.2	25.9	
P6SMBJ15AS	P6SMBJ15CAS	600	15	16.7	18.5	1	1	1	24.4	24.6	
P6SMBJ16AS	P6SMBJ16CAS	600	16	17.8	19.7	1	1	1	26	23.1	
P6SMBJ17AS	P6SMBJ17CAS	600	17	18.9	20.9	1	1	1	27.6	21.8	
P6SMBJ18AS	P6SMBJ18CAS	600	18	20	22.1	1	1	1	29.2	20.6	
P6SMBJ20AS	P6SMBJ20CAS	600	20	22.2	24.5	1	1	1	32.4	18.6	
P6SMBJ22AS	P6SMBJ22CAS	600	22	24.4	26.9	1	1	1	35.5	16.9	
P6SMBJ24AS	P6SMBJ24CAS	600	24	26.7	29.5	1	1	1	38.9	15.5	
P6SMBJ26AS	P6SMBJ26CAS	600	26	28.9	31.9	1	1	1	42.1	14.3	
P6SMBJ28AS	P6SMBJ28CAS	600	28	31.1	34.4	1	1	1	45.4	13.3	

Transient Voltage Suppressors

Part Number		P _D	V _{RWM}	V _{BR} @ I _T (V)		I _T	I _R @ V _{RWM} (μA)		V _C @ I _{PP} Max.	I _{PP}	Package
UNI	BI	W	V	Min.	Max.	mA	UNI	BI	V	A	
P6SMBJ30AS	P6SMBJ30CAS	600	30	33.3	36.8	1	1	1	48.4	12.4	SMB
P6SMBJ33AS	P6SMBJ33CAS	600	33	36.7	40.6	1	1	1	53.3	11.3	
P6SMBJ36AS	P6SMBJ36CAS	600	36	40	44.2	1	1	1	58.1	10.4	
P6SMBJ40AS	P6SMBJ40CAS	600	40	44.4	49.1	1	1	1	64.5	9.3	
P6SMBJ43AS	P6SMBJ43CAS	600	43	47.8	52.8	1	1	1	69.4	8.7	
P6SMBJ45AS	P6SMBJ45CAS	600	45	50	55.3	1	1	1	72.7	8.7	
P6SMBJ48AS	P6SMBJ48CAS	600	48	53.3	58.9	1	1	1	77.4	8.3	
P6SMBJ51AS	P6SMBJ51CAS	600	51	56.7	62.7	1	1	1	82.4	7.3	
P6SMBJ54AS	P6SMBJ54CAS	600	54	60	66.3	1	1	1	87.1	6.9	
P6SMBJ58AS	P6SMBJ58CAS	600	58	64.4	71.2	1	1	1	93.6	6.5	
P6SMBJ60AS	P6SMBJ60CAS	600	60	66.7	73.7	1	1	1	96.8	6.2	
P6SMBJ64AS	P6SMBJ64CAS	600	64	71.1	78.6	1	1	1	103	5.9	
P6SMBJ70AS	P6SMBJ70CAS	600	70	77.8	86	1	1	1	113	5.3	
P6SMBJ75AS	P6SMBJ75CAS	600	75	83.3	92.1	1	1	1	121	5	
P6SMBJ78AS	P6SMBJ78CAS	600	78	86.7	95.8	1	1	1	126	4.8	
P6SMBJ85AS	P6SMBJ85CAS	600	85	94.4	104	1	1	1	137	4.4	
P6SMBJ90AS	P6SMBJ90CAS	600	90	100	111	1	1	1	147	4.1	
P6SMBJ100AS	P6SMBJ100CAS	600	100	111	123	1	1	1	162	3.7	
P6SMBJ110AS	P6SMBJ110CAS	600	110	122	135	1	1	1	177	3.4	
P6SMBJ120AS	P6SMBJ120CAS	600	120	133	147	1	1	1	193	3.1	
P6SMBJ130AS	P6SMBJ130CAS	600	130	144	159	1	1	1	209	2.9	
P6SMBJ150AS	P6SMBJ150CAS	600	150	167	185	1	1	1	243	2.5	
P6SMBJ160AS	P6SMBJ160CAS	600	160	178	197	1	1	1	259	2.3	
P6SMBJ170AS	P6SMBJ170CAS	600	170	189	209	1	1	1	275	2.2	
P6SMBJ180AS	P6SMBJ180CAS	600	180	198	222	1	1	1	292	2.1	
P6SMBJ190AS	P6SMBJ190CAS	600	190	209	243.2	1	1	1	308	2	
P6SMBJ200AS	P6SMBJ200CAS	600	200	220	247	1	1	1	324	1.9	
P6SMBJ210AS	P6SMBJ210CAS	600	210	231	268.8	1	1	1	340	1.8	
P6SMBJ220AS	P6SMBJ220CAS	600	220	242	272	1	1	1	356	1.7	
1.5SMC10AS	1.5SMC10CAS	1500	8.55	9.5	10.5	1	10	20	14.5	103	
1.5SMC11AS	1.5SMC11CAS	1500	9.4	10.5	11.6	1	5	10	15.6	96	
1.5SMC12AS	1.5SMC12CAS	1500	10.2	11.4	12.6	1	5	5	16.7	90	
1.5SMC13AS	1.5SMC13CAS	1500	11.1	12.4	13.7	1	1	1	18.2	82	
1.5SMC15AS	1.5SMC15CAS	1500	12.8	14.3	15.8	1	1	1	21.2	71	
1.5SMC16AS	1.5SMC16CAS	1500	13.6	15.2	16.8	1	1	1	22.5	67	
1.5SMC18AS	1.5SMC18CAS	1500	15.3	17.1	18.9	1	1	1	25.2	59.5	
1.5SMC20AS	1.5SMC20CAS	1500	17.1	19	21	1	1	1	27.7	54	
1.5SMC22AS	1.5SMC22CAS	1500	18.8	20.9	23.1	1	1	1	30.6	49	
1.5SMC24AS	1.5SMC24CAS	1500	20.5	22.8	25.2	1	1	1	33.2	45	
1.5SMC27AS	1.5SMC27CAS	1500	23.1	25.7	28.4	1	1	1	37.5	40	
1.5SMC30AS	1.5SMC30CAS	1500	25.6	28.5	31.5	1	1	1	41.4	36	
1.5SMC33AS	1.5SMC33CAS	1500	28.2	31.4	34.7	1	1	1	45.7	33	
1.5SMC36AS	1.5SMC36CAS	1500	30.8	34.2	37.8	1	1	1	49.9	30	
1.5SMC39AS	1.5SMC39CAS	1500	33.3	37.1	41	1	1	1	53.9	28	
1.5SMC43AS	1.5SMC43CAS	1500	36.8	40.9	45.2	1	1	1	59.3	25.3	
1.5SMC47AS	1.5SMC47CAS	1500	40.2	44.7	49.4	1	1	1	64.8	23.2	
1.5SMC51AS	1.5SMC51CAS	1500	43.6	48.5	53.6	1	1	1	70.1	21.4	
1.5SMC56AS	1.5SMC56CAS	1500	47.8	53.2	58.8	1	1	1	77	19.5	
1.5SMC62AS	1.5SMC62CAS	1500	53	58.9	65.1	1	1	1	85	17.7	
1.5SMC68AS	1.5SMC68CAS	1500	58.1	64.6	71.4	1	1	1	92	16.3	
1.5SMC75AS	1.5SMC75CAS	1500	64.1	71.3	78.8	1	1	1	103	14.6	
1.5SMC82AS	1.5SMC82CAS	1500	70.1	77.9	86.1	1	1	1	113	13.3	
1.5SMC91AS	1.5SMC91CAS	1500	77.8	86.5	95.5	1	1	1	125	12	
1.5SMC100AS	1.5SMC100CAS	1500	85.5	95	105	1	1	1	137	11	
1.5SMC110AS	1.5SMC110CAS	1500	94	105	116	1	1	1	152	9.9	
1.5SMC120AS	1.5SMC120CAS	1500	102	114	126	1	1	1	165	9.1	
1.5SMC130AS	1.5SMC130CAS	1500	111	124	137	1	1	1	179	8.4	
1.5SMC150AS	1.5SMC150CAS	1500	128	143	158	1	1	1	207	7.2	

Transient Voltage Suppressors

Part Number		P _D	V _{RWM}	V _{BR} @ I _T (V)		I _T	I _R @ V _{RWM} (μA)		V _C @ I _{PP} Max.	I _{PP}	Package
UNI	BI	W	V	Min.	Max.	mA	UNI	BI	V	A	
1.5SMC160AS	1.5SMC160CAS	1500	136	152	168	1	1	1	219	6.8	SMC
1.5SMC170AS	1.5SMC170CAS	1500	145	162	179	1	1	1	234	6.4	
1.5SMC180AS	1.5SMC180CAS	1500	154	171	189	1	1	1	246	6.1	
1.5SMC200AS	1.5SMC200CAS	1500	171	190	210	1	1	1	274	5.5	
1.5SMC220AS	1.5SMC220CAS	1500	185	209	231	1	1	1	328	4.6	
1.5SMC250AS	1.5SMC250CAS	1500	214	237	263	1	1	1	344	4.5	
1.5SMCJ8.5AS	1.5SMCJ8.5CAS	1500	8.5	9.44	10.82	1	25	50	14.4	104.2	
1.5SMCJ9.0AS	1.5SMCJ9.0CAS	1500	9	10	11.5	1	10	20	15.4	97.4	
1.5SMCJ10AS	1.5SMCJ10CAS	1500	10	11.1	12.8	1	5	5	17	88.2	
1.5SMCJ11AS	1.5SMCJ11CAS	1500	11	12.2	14	1	1	1	18.2	82.4	
1.5SMCJ12AS	1.5SMCJ12CAS	1500	12	13.3	15.3	1	1	1	19.9	75.3	
1.5SMCJ13AS	1.5SMCJ13CAS	1500	13	14.4	16.5	1	1	1	21.5	69.7	
1.5SMCJ14AS	1.5SMCJ14CAS	1500	14	15.6	17.9	1	1	1	23.2	64.7	
1.5SMCJ15AS	1.5SMCJ15CAS	1500	15	16.7	19.2	1	1	1	24.4	61.5	
1.5SMCJ16AS	1.5SMCJ16CAS	1500	16	17.8	20.5	1	1	1	26	57.7	
1.5SMCJ17AS	1.5SMCJ17CAS	1500	17	18.9	21.7	1	1	1	27.6	53.3	
1.5SMCJ18AS	1.5SMCJ18CAS	1500	18	20	23.3	1	1	1	29.2	51.4	
1.5SMCJ20AS	1.5SMCJ20CAS	1500	20	22.2	25.5	1	1	1	32.4	46.3	
1.5SMCJ22AS	1.5SMCJ22CAS	1500	22	24.4	28	1	1	1	35.5	42.2	
1.5SMCJ24AS	1.5SMCJ24CAS	1500	24	26.7	30.7	1	1	1	38.9	38.6	
1.5SMCJ26AS	1.5SMCJ26CAS	1500	26	28.9	33.2	1	1	1	42.1	35.6	
1.5SMCJ28AS	1.5SMCJ28CAS	1500	28	31.1	35.8	1	1	1	45.4	33	
1.5SMCJ30AS	1.5SMCJ30CAS	1500	30	33.3	38.3	1	1	1	48.4	31	
1.5SMCJ33AS	1.5SMCJ33CAS	1500	33	36.7	42.2	1	1	1	53.3	28.1	
1.5SMCJ36AS	1.5SMCJ36CAS	1500	36	40	46	1	1	1	58.1	25.8	
1.5SMCJ40AS	1.5SMCJ40CAS	1500	40	44.4	51.1	1	1	1	64.5	23.2	
1.5SMCJ43AS	1.5SMCJ43CAS	1500	43	47.8	55	1	1	1	69.4	21.6	
1.5SMCJ45AS	1.5SMCJ45CAS	1500	45	50	57.5	1	1	1	72.7	20.6	
1.5SMCJ48AS	1.5SMCJ48CAS	1500	48	53.3	61.3	1	1	1	77.4	19.4	
1.5SMCJ51AS	1.5SMCJ51CAS	1500	51	56.7	65.2	1	1	1	82.4	18.2	
1.5SMCJ54AS	1.5SMCJ54CAS	1500	54	60	69	1	1	1	87.1	17.2	
1.5SMCJ58AS	1.5SMCJ58CAS	1500	58	64.4	74.1	1	1	1	93.6	16	
1.5SMCJ60AS	1.5SMCJ60CAS	1500	60	66.7	76.7	1	1	1	96.8	15.5	
1.5SMCJ64AS	1.5SMCJ64CAS	1500	64	71.1	81.8	1	1	1	103	14.6	
1.5SMCJ70AS	1.5SMCJ70CAS	1500	70	77.8	89.5	1	1	1	113	13.3	
1.5SMCJ75AS	1.5SMCJ75CAS	1500	75	83.3	95.8	1	1	1	121	12.4	
1.5SMCJ78AS	1.5SMCJ78CAS	1500	78	86.7	99.7	1	1	1	126	11.4	
1.5SMCJ85AS	1.5SMCJ85CAS	1500	85	94.4	108.2	1	1	1	137	10.4	
1.5SMCJ90AS	1.5SMCJ90CAS	1500	90	100	115.5	1	1	1	146	10.3	
1.5SMCJ100AS	1.5SMCJ100CAS	1500	100	111	128	1	1	1	162	9.3	
1.5SMCJ110AS	1.5SMCJ110CAS	1500	110	122	140.5	1	1	1	177	8.4	
1.5SMCJ120AS	1.5SMCJ120CAS	1500	120	133	153	1	1	1	193	7.9	
1.5SMCJ130AS	1.5SMCJ130CAS	1500	130	144	165.5	1	1	1	209	7.2	
1.5SMCJ150AS	1.5SMCJ150CAS	1500	150	167	192.5	1	1	1	243	6.2	
1.5SMCJ160AS	1.5SMCJ160CAS	1500	160	178	205	1	1	1	259	5.8	
1.5SMCJ170AS	1.5SMCJ170CAS	1500	170	189	217.5	1	1	1	275	5.5	
1.5SMCJ180AS	1.5SMCJ180CAS	1500	180	198	230.4	1	1	1	292	5.1	
1.5SMCJ190AS	1.5SMCJ190CAS	1500	190	209	243.2	1	1	1	308	4.8	
1.5SMCJ200AS	1.5SMCJ200CAS	1500	200	220	256	1	1	1	324	4.6	
1.5SMCJ210AS	1.5SMCJ210CAS	1500	210	231	268.8	1	1	1	340	4.4	
1.5SMCJ220AS	1.5SMCJ220CAS	1500	220	242	281.6	1	1	1	356	4.2	

Transient Voltage Suppressors

Part Number		P _D	V _{RWM}	V _{BR} @ I _T (V)		I _T mA	I _R @ V _{RWM} (μA)		V _C @ I _{PP} Max.	I _{PP} A	Package
UNI	BI			W	V		Min.	Max.			
3.0SMCJ5.0A	3.0SMCJ5.0CA	3000	5	6.4	7.25	10	1000	2000	9.2	326	SMC
3.0SMCJ6.0A	3.0SMCJ6.0CA	3000	6	6.67	7.67	10	1000	2000	10.3	291.3	
3.0SMCJ6.5A	3.0SMCJ6.5CA	3000	6.5	7.22	8.3	10	500	1000	11.2	267.9	
3.0SMCJ7.0A	3.0SMCJ7.0CA	3000	7	7.78	8.95	10	200	400	12	250	
3.0SMCJ7.5A	3.0SMCJ7.5CA	3000	7.5	8.33	9.6	1	100	200	12.9	232.6	
3.0SMCJ8.0A	3.0SMCJ8.0CA	3000	8	8.89	10.23	1	50	100	13.6	220.6	
3.0SMCJ8.5A	3.0SMCJ8.5CA	3000	8.5	9.44	10.82	1	25	50	14.4	208.4	
3.0SMCJ9.0A	3.0SMCJ9.0CA	3000	9	10	11.5	1	10	20	15.4	194.8	
3.0SMCJ10A	3.0SMCJ10CA	3000	10	11.1	12.8	1	3	3	17	176.4	
3.0SMCJ11A	3.0SMCJ11CA	3000	11	12.2	14	1	3	3	18.2	184.8	
3.0SMCJ12A	3.0SMCJ12CA	3000	12	13.3	15.3	1	3	3	19.9	150.6	
3.0SMCJ13A	3.0SMCJ13CA	3000	13	14.4	16.5	1	3	3	21.5	139.4	
3.0SMCJ14A	3.0SMCJ14CA	3000	14	15.6	17.9	1	3	3	23.2	129.4	
3.0SMCJ15A	3.0SMCJ15CA	3000	15	16.7	19.2	1	3	3	24.4	123	
3.0SMCJ16A	3.0SMCJ16CA	3000	16	17.8	20.5	1	3	3	26	115.4	
3.0SMCJ17A	3.0SMCJ17CA	3000	17	18.9	21.7	1	3	3	27.6	106.6	
3.0SMCJ18A	3.0SMCJ18CA	3000	18	20	23.3	1	3	3	29.2	102.8	
3.0SMCJ20A	3.0SMCJ20CA	3000	20	22.2	25.5	1	3	3	32.4	92.6	
3.0SMCJ22A	3.0SMCJ22CA	3000	22	24.4	28	1	3	3	35.5	84.4	
3.0SMCJ24A	3.0SMCJ24CA	3000	24	26.7	30.7	1	3	3	38.9	77.2	
3.0SMCJ26A	3.0SMCJ26CA	3000	26	28.9	33.2	1	3	3	42.1	71.2	
3.0SMCJ28A	3.0SMCJ28CA	3000	28	31.1	35.8	1	3	3	45.4	66	
3.0SMCJ30A	3.0SMCJ30CA	3000	30	33.3	38.3	1	3	3	48.4	62	
3.0SMCJ33A	3.0SMCJ33CA	3000	33	36.7	42.2	1	3	3	53.3	56.2	
3.0SMCJ36A	3.0SMCJ36CA	3000	36	40	46	1	3	3	58.1	51.6	
3.0SMCJ40A	3.0SMCJ40CA	3000	40	44.4	51.1	1	3	3	64.5	46.4	
3.0SMCJ43A	3.0SMCJ43CA	3000	43	47.8	54.9	1	3	3	69.4	43.2	
3.0SMCJ45A	3.0SMCJ45CA	3000	45	50	57.5	1	3	3	72.7	41.2	
3.0SMCJ48A	3.0SMCJ48CA	3000	48	53.3	61.3	1	3	3	77.4	38.8	
3.0SMCJ51A	3.0SMCJ51CA	3000	51	56.7	65.2	1	3	3	82.4	36.4	
3.0SMCJ54A	3.0SMCJ54CA	3000	54	60	69	1	3	3	87.1	34.4	
3.0SMCJ58A	3.0SMCJ58CA	3000	58	64.4	74.1	1	3	3	93.6	32	
3.0SMCJ60A	3.0SMCJ60CA	3000	60	66.7	76.7	1	3	3	96.8	31	
3.0SMCJ64A	3.0SMCJ64CA	3000	64	71.1	81.8	1	3	3	103	29.2	
3.0SMCJ70A	3.0SMCJ70CA	3000	70	77.8	89.5	1	3	3	113	26.6	
3.0SMCJ75A	3.0SMCJ75CA	3000	75	83.3	95.8	1	3	3	121	24.8	
3.0SMCJ78A	3.0SMCJ78CA	3000	78	86.7	99.7	1	3	3	126	22.8	
3.0SMCJ85A	3.0SMCJ85CA	3000	85	94.4	108.2	1	3	3	137	20.8	
3.0SMCJ90A	3.0SMCJ90CA	3000	90	100	115.5	1	3	3	146	20.6	
3.0SMCJ100A	3.0SMCJ100CA	3000	100	111	128	1	3	3	162	18.6	
3.0SMCJ110A	3.0SMCJ110CA	3000	110	122	140.5	1	3	3	177	16.8	
3.0SMCJ120A	3.0SMCJ120CA	3000	120	133	153	1	3	3	193	15.6	
3.0SMCJ130A	3.0SMCJ130CA	3000	130	144	165.5	1	3	3	209	14.4	
3.0SMCJ150A	3.0SMCJ150CA	3000	150	167	192.5	1	3	3	243	12.4	
3.0SMCJ160A	3.0SMCJ160CA	3000	160	178	205	1	3	3	259	11.6	
3.0SMCJ170A	3.0SMCJ170CA	3000	170	189	217.5	1	3	3	275	11	
3.0SMCJ180A	3.0SMCJ180CA	3000	180	198	230.4	1	3	3	292	10.3	
3.0SMCJ190A	3.0SMCJ190CA	3000	190	209	243.2	1	3	3	308	9.7	
3.0SMCJ200A	3.0SMCJ200CA	3000	200	220	256	1	3	3	324	9.3	
3.0SMCJ210A	3.0SMCJ210CA	3000	210	231	268.8	1	3	3	340	8.8	
3.0SMCJ220A	3.0SMCJ220CA	3000	220	242	281.6	1	3	3	356	8.4	

Transient Voltage Suppressors

Part Number		P _D	V _{RWM}	V _{BR} @ I _T (V)		I _T mA	I _R @ V _{RWM} (μA)		V _C @ I _{PP} Max. V	I _{PP} A	Package
UNI	BI			W	V		Min.	Max.			
5KMC12AS	5KMC12CAS	5000	12	13.3	14.7	10	5	5	19.9	252	SMC
5KMC13AS	5KMC13CAS	5000	13	14.4	15.9	10	5	5	21.5	233	
5KMC14AS	5KMC14CAS	5000	14	15.6	17.2	10	5	5	23.2	216	
5KMC15AS	5KMC15CAS	5000	15	16.7	18.5	1	5	5	24.4	205	
5KMC16AS	5KMC16CAS	5000	16	17.8	19.7	1	5	5	26	193	
5KMC17AS	5KMC17CAS	5000	17	18.9	20.9	1	5	5	27.6	181	
5KMC18AS	5KMC18CAS	5000	18	20	22.1	1	5	5	29.2	172	
5KMC20AS	5KMC20CAS	5000	20	22.2	24.5	1	5	5	32.4	155	
5KMC22AS	5KMC22CAS	5000	22	24.4	26.9	1	5	5	35.5	141	
5KMC24AS	5KMC24CAS	5000	24	26.7	29.5	1	5	5	38.9	129	
5KMC26AS	5KMC26CAS	5000	26	28.9	31.9	1	5	5	42.1	119	
5KMC28AS	5KMC28CAS	5000	28	31.1	34.4	1	5	5	45.4	110	
5KMC30AS	5KMC30CAS	5000	30	33.3	36.8	1	5	5	48.4	103	
5KMC33AS	5KMC33CAS	5000	33	36.7	40.6	1	5	5	53.3	93.9	
5KMC36AS	5KMC36CAS	5000	36	40	44.2	1	5	5	58.1	86.1	
5KMC40AS	-	5000	40	44.4	49.1	1	5	-	64.5	77.6	
5KMC43AS	-	5000	43	47.8	52.8	1	5	-	69.4	72.1	
5KMC45AS	-	5000	45	50	55.3	1	5	-	72.7	68.8	
5KMC48AS	-	5000	48	53.3	58.9	1	5	-	77.4	64.7	
5KMC51AS	-	5000	51	56.7	62.7	1	5	-	82.4	60.7	
5KMC54AS	-	5000	54	60	66.3	1	5	-	87.1	57.5	
5KMC58AS	-	5000	58	64.4	71.2	1	5	-	93.6	53.5	
5KMC60AS	-	5000	60	66.7	73.7	1	5	-	96.8	51.7	
5KMC64AS	-	5000	64	71.1	78.6	1	5	-	103	48.6	
5KMC70AS	-	5000	70	77.8	86	1	5	-	113	44.3	
5KMC75AS	-	5000	75	83.3	92.1	1	5	-	121	41.4	
5KMC78AS	-	5000	78	86.7	95.8	1	5	-	126	39.7	
5KMC85AS	-	5000	85	94.4	104	1	5	-	137	36.5	
5KMC90AS	-	5000	90	100	111	1	5	-	146	34.3	
5KMC100AS	-	5000	100	111	123	1	5	-	162	30.9	

Transient Voltage Suppressors

Part Number		P _D	V _{RWM}	V _{BR} @ I _T (V)		I _T	I _R @ V _{RWM} (μA)		V _C @ I _{PP} Max.	I _{PP}	Package
UNI	BI	W	V	Min.	Max.	mA	UNI	BI	V	A	
P6KE10AS	P6KE10CAS	600	8.55	9.5	10.5	1	10	20	14.5	41	DO-15
P6KE11AS	P6KE11CAS	600	9.4	10.5	11.6	1	5	10	15.6	38	
P6KE12AS	P6KE12CAS	600	10.2	11.4	12.6	1	5	5	16.7	36	
P6KE13AS	P6KE13CAS	600	11.1	12.4	13.7	1	1	1	18.2	33	
P6KE15AS	P6KE15CAS	600	12.8	14.3	15.8	1	1	1	21.2	28	
P6KE16AS	P6KE16CAS	600	13.6	15.2	16.8	1	1	1	22.5	27	
P6KE18AS	P6KE18CAS	600	15.3	17.1	18.9	1	1	1	25.2	24	
P6KE20AS	P6KE20CAS	600	17.1	19	21	1	1	1	27.7	22	
P6KE22AS	P6KE22CAS	600	18.8	20.9	23.1	1	1	1	30.6	20	
P6KE24AS	P6KE24CAS	600	20.5	22.8	25.2	1	1	1	33.2	18	
P6KE27AS	P6KE27CAS	600	23.1	25.7	28.4	1	1	1	37.5	16	
P6KE30AS	P6KE30CAS	600	25.6	28.5	31.5	1	1	1	41.4	14.4	
P6KE33AS	P6KE33CAS	600	28.2	31.4	34.7	1	1	1	45.7	13.2	
P6KE36AS	P6KE36CAS	600	30.8	34.2	37.8	1	1	1	49.9	12	
P6KE39AS	P6KE39CAS	600	33.3	37.1	41	1	1	1	53.9	11.2	
P6KE43AS	P6KE43CAS	600	36.8	40.9	45.2	1	1	1	59.3	10.1	
P6KE47AS	P6KE47CAS	600	40.2	44.7	49.4	1	1	1	64.8	9.3	
P6KE51AS	P6KE51CAS	600	43.6	48.5	53.6	1	1	1	70.1	8.6	
P6KE56AS	P6KE56CAS	600	47.8	53.2	58.8	1	1	1	77	7.8	
P6KE62AS	P6KE62CAS	600	53	58.9	65.1	1	1	1	85	7.1	
P6KE68AS	P6KE68CAS	600	58.1	64.6	71.4	1	1	1	92	6.5	
P6KE75AS	P6KE75CAS	600	64.1	71.3	78.8	1	1	1	103	5.8	
P6KE82AS	P6KE82CAS	600	70.1	77.9	86.1	1	1	1	113	5.3	
P6KE91AS	P6KE91CAS	600	77.8	86.5	95.5	1	1	1	125	4.8	
P6KE100AS	P6KE100CAS	600	85.5	95	105	1	1	1	137	4.4	
P6KE110AS	P6KE110CAS	600	94	105	116	1	1	1	152	4	
P6KE120AS	P6KE120CAS	600	102	114	126	1	1	1	165	3.6	
P6KE130AS	P6KE130CAS	600	111	124	137	1	1	1	179	3.3	
P6KE150AS	P6KE150CAS	600	128	143	158	1	1	1	207	2.9	
P6KE160AS	P6KE160CAS	600	136	152	168	1	1	1	219	2.7	
P6KE170AS	P6KE170CAS	600	145	162	179	1	1	1	234	2.6	
P6KE180AS	P6KE180CAS	600	154	171	189	1	1	1	246	2.4	
P6KE200AS	P6KE200CAS	600	171	190	210	1	1	1	274	2.2	
P6KE220AS	P6KE220CAS	600	185	209	231	1	1	1	328	1.9	
P6KE250AS	P6KE250CAS	600	214	237	263	1	1	1	344	1.8	

Transient Voltage Suppressors

Part Number		P _D	V _{RWM}	V _{BR} @ I _T (V)		I _T	I _R @ V _{RWM} (μA)		V _C @ I _{PP} Max.	I _{PP}	Package
UNI	BI	W	V	Min.	Max.	mA	UNI	BI	V	A	
P4KE10AS	P4KE10CAS	400	8.55	9.5	10.5	1	10	20	14.5	29	DO-41
P4KE11AS	P4KE11CAS	400	9.4	10.5	11.6	1	5	10	15.6	27	
P4KE12AS	P4KE12CAS	400	10.2	11.4	12.6	1	1	1	16.7	25	
P4KE13AS	P4KE13CAS	400	11.1	12.4	13.7	1	1	1	18.2	23	
P4KE15AS	P4KE15CAS	400	12.8	14.3	15.8	1	1	1	21.2	20	
P4KE16AS	P4KE16CAS	400	13.6	15.2	16.8	1	1	1	22.5	19	
P4KE18AS	P4KE18CAS	400	15.3	17.1	18.9	1	1	1	25.2	17	
P4KE20AS	P4KE20CAS	400	17.1	19	21	1	1	1	27.7	15	
P4KE22AS	P4KE22CAS	400	18.8	20.9	23.1	1	1	1	30.6	14	
P4KE24AS	P4KE24CAS	400	20.5	22.8	25.2	1	1	1	33.2	13	
P4KE27AS	P4KE27CAS	400	23.1	25.7	28.4	1	1	1	37.5	11.2	
P4KE30AS	P4KE30CAS	400	25.6	28.5	31.5	1	1	1	41.4	10	
P4KE33AS	P4KE33CAS	400	28.2	31.4	34.7	1	1	1	45.7	9	
P4KE36AS	P4KE36CAS	400	30.8	34.2	37.8	1	1	1	49.9	8.4	
P4KE39AS	P4KE39CAS	400	33.3	37.1	41	1	1	1	53.9	7.8	
P4KE43AS	P4KE43CAS	400	36.8	40.9	45.2	1	1	1	59.3	7.1	
P4KE47AS	P4KE47CAS	400	40.2	44.7	49.4	1	1	1	64.8	5	
P4KE51AS	P4KE51CAS	400	43.6	48.5	53.6	1	1	1	70.1	6	
P4KE56AS	P4KE56CAS	400	47.8	53.2	58.8	1	1	1	77	5.5	
P4KE62AS	P4KE62CAS	400	53	58.9	65.1	1	1	1	85	5	
P4KE68AS	P4KE68CAS	400	58.1	64.6	71.4	1	1	1	92	4.6	
P4KE75AS	P4KE75CAS	400	64.1	71.3	78.8	1	1	1	103	4.1	
P4KE82AS	P4KE82CAS	400	70.1	77.9	86.1	1	1	1	113	3.7	
P4KE91AS	P4KE91CAS	400	77.8	86.5	95.5	1	1	1	125	3.4	
P4KE100AS	P4KE100CAS	400	85.5	95	105	1	1	1	137	3.1	
P4KE110AS	P4KE110CAS	400	94	105	116	1	1	1	152	2.8	
P4KE120AS	P4KE120CAS	400	102	114	126	1	1	1	165	2.5	
P4KE130AS	P4KE130CAS	400	111	124	137	1	1	1	179	2.3	
P4KE150AS	P4KE150CAS	400	128	143	158	1	1	1	207	2	
P4KE160AS	P4KE160CAS	400	136	152	168	1	1	1	219	1.9	
P4KE170AS	P4KE170CAS	400	145	162	179	1	1	1	234	1.8	
P4KE180AS	P4KE180CAS	400	154	171	189	1	1	1	246	1.7	
P4KE200AS	P4KE200CAS	400	171	190	210	1	1	1	274	1.5	
P4KE220AS	P4KE220CAS	400	185	209	231	1	1	1	328	1.2	
P4KE250AS	P4KE250CAS	400	214	237	263	1	1	1	344	1.2	

Transient Voltage Suppressors

Part Number		P _D	V _{RWM}	V _{BR} @ I _T (V)		I _T	I _R @ V _{RWM} (μA)		V _C @ I _{PP} Max.	I _{PP}	Package
UNI	BI			W	V		Min.	Max.			
1.5KE6.8A	1.5KE6.8CA	1500	5.8	6.45	7.14	10	1000	-	10.5	143	DO-201AE
1.5KE7.5A	1.5KE7.5CA	1500	6.4	7.13	7.88	10	500	-	11.3	132	
1.5KE8.2A	1.5KE8.2CA	1500	7.02	7.79	8.61	10	200	-	12.1	124	
1.5KE9.1A	1.5KE9.1CA	1500	7.78	8.65	9.5	1	50	-	13.4	112	
1.5KE10A	1.5KE10CA	1500	8.55	9.5	10.5	1	10	-	14.5	103	
1.5KE11A	1.5KE11CA	1500	9.4	10.5	11.6	1	5	-	15.6	96	
1.5KE12A	1.5KE12CA	1500	10.2	11.4	12.6	1	5	-	16.7	90	
1.5KE13A	1.5KE13CA	1500	11.1	12.4	13.7	1	1	-	18.2	82	
1.5KE15A	1.5KE15CA	1500	12.8	14.3	15.8	1	1	-	21.2	71	
1.5KE16A	1.5KE16CA	1500	13.6	15.2	16.8	1	1	-	22.5	67	
1.5KE18A	1.5KE18CA	1500	15.3	17.1	18.9	1	1	-	25.2	59.5	
1.5KE20A	1.5KE20CA	1500	17.1	19	21	1	1	-	27.7	54	
1.5KE22A	1.5KE22CA	1500	18.8	20.9	23.1	1	1	-	30.6	49	
1.5KE24A	1.5KE24CA	1500	20.5	22.8	25.2	1	1	-	33.2	45	
1.5KE27A	1.5KE27CA	1500	23.1	25.7	28.4	1	1	-	37.5	40	
1.5KE30A	1.5KE30CA	1500	25.6	28.5	31.5	1	1	-	41.4	36	
1.5KE33A	1.5KE33CA	1500	28.2	31.4	34.7	1	1	-	45.7	33	
1.5KE36A	1.5KE36CA	1500	30.8	34.2	37.8	1	1	-	49.9	30	
1.5KE39A	1.5KE39CA	1500	33.3	37.1	41	1	1	-	53.9	28	
1.5KE43A	1.5KE43CA	1500	36.8	40.9	45.2	1	1	-	59.3	25.3	
1.5KE47A	1.5KE47CA	1500	40.2	44.7	49.4	1	1	-	64.8	23.2	
1.5KE51A	1.5KE51CA	1500	43.6	48.5	53.6	1	1	-	70.1	21.4	
1.5KE56A	1.5KE56CA	1500	47.8	53.2	58.8	1	1	-	77	19.5	
1.5KE62A	1.5KE62CA	1500	53	58.9	65.1	1	1	-	85	17.7	
1.5KE68A	1.5KE68CA	1500	58.1	64.6	71.4	1	1	-	92	16.3	
1.5KE75A	1.5KE75CA	1500	64.1	71.3	78.8	1	1	-	103	14.6	
1.5KE82A	1.5KE82CA	1500	70.1	77.9	86.1	1	1	-	113	13.3	
1.5KE91A	1.5KE91CA	1500	77.8	86.5	95.5	1	1	-	125	12	
1.5KE100A	1.5KE100CA	1500	85.5	95	105	1	1	-	137	11	
1.5KE110A	1.5KE110CA	1500	94	105	116	1	1	-	152	9.9	
1.5KE120A	1.5KE120CA	1500	102	114	126	1	1	-	165	9.1	
1.5KE130A	1.5KE130CA	1500	111	124	137	1	1	-	179	8.4	
1.5KE150A	1.5KE150CA	1500	128	143	158	1	1	-	207	7.2	
1.5KE160A	1.5KE160CA	1500	136	152	168	1	1	-	219	6.8	
1.5KE170A	1.5KE170CA	1500	145	162	179	1	1	-	234	6.4	
1.5KE180A	1.5KE180CA	1500	154	171	189	1	1	-	246	6.1	
1.5KE200A	1.5KE200CA	1500	171	190	210	1	1	-	274	5.5	
1.5KE220A	1.5KE220CA	1500	185	209	231	1	1	-	328	4.6	
1.5KE250A	1.5KE250CA	1500	214	237	263	1	1	-	344	4.5	
1.5KE300A	1.5KE300CA	1500	256	285	315	1	1	-	414	3.8	
1.5KE350A	1.5KE350CA	1500	300	332	368	1	1	-	482	3.2	
1.5KE400A	1.5KE400CA	1500	342	380	420	1	1	-	548	2.8	
1.5KE440A	1.5KE440CA	1500	376	418	462	1	1	-	600	2.6	

Transient Voltage Suppressors

Part Number		P _D	V _{RWM}	V _{BR} @ I _T (V)		I _T mA	I _R @ V _{RWM} (μA)		V _C @ I _{PP} Max.	I _{PP} A	Package
UNI	BI			W	V		Min.	Max.			
3KP5.0A	3KP5.0CA	3000	5	6.4	7.25	10	1000	2000	9.2	326	P-600
3KP6.0A	3KP6.0CA	3000	6	6.67	7.67	10	1000	2000	10.3	291.3	
3KP6.5A	3KP6.5CA	3000	6.5	7.22	8.3	10	500	1000	11.2	267.9	
3KP7.0A	3KP7.0CA	3000	7	7.78	8.95	10	200	400	12	250	
3KP7.5A	3KP7.5CA	3000	7.5	8.33	9.58	1	100	200	12.9	232.6	
3KP8.0A	3KP8.0CA	3000	8	8.89	10.23	1	50	100	13.6	220.6	
3KP8.5A	3KP8.5CA	3000	8.5	9.44	10.82	1	25	50	14.4	208.4	
3KP9.0A	3KP9.0CA	3000	9	10	11.5	1	10	20	15.4	194.8	
3KP10A	3KP10CA	3000	10	11.1	12.8	1	3	3	17	176.4	
3KP11A	3KP11CA	3000	11	12.2	14	1	3	3	18.2	184.8	
3KP12A	3KP12CA	3000	12	13.3	15.3	1	3	3	19.9	150.6	
3KP13A	3KP13CA	3000	13	14.4	16.5	1	3	3	21.5	139.4	
3KP14A	3KP14CA	3000	14	15.6	17.9	1	3	3	23.2	129.4	
3KP15A	3KP15CA	3000	15	16.7	19.2	1	3	3	24.4	123	
3KP16A	3KP16CA	3000	16	17.8	20.5	1	3	3	26	115.4	
3KP17A	3KP17CA	3000	17	18.9	21.7	1	3	3	27.6	106.6	
3KP18A	3KP18CA	3000	18	20	23.3	1	3	3	29.2	102.8	
3KP20A	3KP20CA	3000	20	22.2	25.5	1	3	3	32.4	92.6	
3KP22A	3KP22CA	3000	22	24.4	28	1	3	3	35.5	84.4	
3KP24A	3KP24CA	3000	24	26.7	30.7	1	3	3	38.9	77.2	
3KP26A	3KP26CA	3000	26	28.9	33.2	1	3	3	42.1	71.2	
3KP28A	3KP28CA	3000	28	31.1	35.8	1	3	3	45.4	66	
3KP30A	3KP30CA	3000	30	33.3	38.3	1	3	3	48.4	62	
3KP33A	3KP33CA	3000	33	36.7	42.2	1	3	3	53.3	56.2	
3KP36A	3KP36CA	3000	36	40	46	1	3	3	58.1	51.6	
3KP40A	3KP40CA	3000	40	44.4	51.1	1	3	3	64.5	46.4	
3KP43A	3KP43CA	3000	43	47.8	54.9	1	3	3	69.4	43.2	
3KP45A	3KP45CA	3000	45	50	57.5	1	3	3	72.7	41.2	
3KP48A	3KP48CA	3000	48	53.3	61.3	1	3	3	77.4	38.8	
3KP51A	3KP51CA	3000	51	56.7	65.2	1	3	3	82.4	36.4	
3KP54A	3KP54CA	3000	54	60	69	1	3	3	87.1	34.4	
3KP58A	3KP58CA	3000	58	64.4	74.1	1	3	3	93.6	32	
3KP60A	3KP60CA	3000	60	66.7	76.7	1	3	3	96.8	31	
3KP64A	3KP64CA	3000	64	71.1	81.8	1	3	3	103	29.2	
3KP70A	3KP70CA	3000	70	77.8	89.5	1	3	3	113	26.6	
3KP75A	3KP75CA	3000	75	83.3	95.8	1	3	3	121	24.8	
3KP78A	3KP78CA	3000	78	86.7	99.7	1	3	3	126	22.8	
3KP85A	3KP85CA	3000	85	94.4	108.2	1	3	3	137	20.8	
3KP90A	3KP90CA	3000	90	100	115.5	1	3	3	146	20.6	
3KP100A	3KP100CA	3000	100	111	128	1	3	3	162	18.6	
3KP110A	3KP110CA	3000	110	122	140.5	1	3	3	177	16.8	
3KP120A	3KP120CA	3000	120	133	153	1	3	3	193	15.6	
3KP130A	3KP130CA	3000	130	144	165.5	1	3	3	209	14.4	
3KP150A	3KP150CA	3000	150	167	192.5	1	3	3	243	12.4	
3KP160A	3KP160CA	3000	160	178	205	1	3	3	259	11.6	
3KP170A	3KP170CA	3000	170	189	217.5	1	3	3	275	11	
3KP180A	3KP180CA	3000	180	198	230.4	1	3	3	292	10.3	
3KP190A	3KP190CA	3000	190	209	243.2	1	3	3	308	9.7	
3KP200A	3KP200CA	3000	200	220	256	1	3	3	324	9.3	
3KP210A	3KP210CA	3000	210	231	268.8	1	3	3	340	8.8	
3KP220A	3KP220CA	3000	220	242	281.6	1	3	3	356	8.4	

Transient Voltage Suppressors

Part Number		P _D	V _{RWM}	V _{BR} @ I _T (V)		I _T	I _R @ V _{RWM} (μA)		V _C @ I _{PP} Max.	I _{PP}	Package
UNI	BI			W	V		Min.	Max.			
5KP5.0A	5KP5.0CA	5000	5	6.4	7.25	50	5000	10000	9.2	543	P-600
5KP6.0A	5KP6.0CA	5000	6	6.67	7.67	50	5000	10000	10.3	485	
5KP6.5A	5KP6.5CA	5000	6.5	7.22	8.3	50	2000	4000	11.2	447	
5KP7.0A	5KP7.0CA	5000	7	7.78	8.95	50	1000	2000	12	417	
5KP7.5A	5KP7.5CA	5000	7.5	8.33	9.58	5	250	500	12.9	388	
5KP8.0A	5KP8.0CA	5000	8	8.89	10.23	5	150	300	13.6	367	
5KP8.5A	5KP8.5CA	5000	8.5	9.44	10.82	5	50	100	14.4	347	
5KP9.0A	5KP9.0CA	5000	9	10	11.5	5	20	40	15.4	325	
5KP10A	5KP10CA	5000	10	11.1	12.8	5	6	6	17	294	
5KP11A	5KP11CA	5000	11	12.2	14	5	6	6	18.2	274	
5KP12A	5KP12CA	5000	12	13.3	15.3	5	6	6	19.9	251	
5KP13A	5KP13CA	5000	13	14.4	16.5	5	6	6	21.5	232	
5KP14A	5KP14CA	5000	14	15.6	17.9	5	6	6	23.2	215	
5KP15A	5KP15CA	5000	15	16.7	19.2	5	6	6	24.4	206	
5KP16A	5KP16CA	5000	16	17.8	20.5	5	6	6	26	192	
5KP17A	5KP17CA	5000	17	18.9	21.7	5	6	6	27.6	181	
5KP18A	5KP18CA	5000	18	20	23.3	5	6	6	29.2	172	
5KP20A	5KP20CA	5000	20	22.2	25.5	5	6	6	32.4	154	
5KP22A	5KP22CA	5000	22	24.4	28	5	6	6	35.5	141	
5KP24A	5KP24CA	5000	24	26.7	30.7	5	6	6	38.9	128	
5KP26A	5KP26CA	5000	26	28.9	33.2	5	6	6	42.1	119	
5KP28A	5KP28CA	5000	28	31.1	35.8	5	6	6	45.4	110	
5KP30A	5KP30CA	5000	30	33.3	38.3	5	6	6	48.4	103	
5KP33A	5KP33CA	5000	33	36.7	42.2	5	6	6	53.3	94	
5KP36A	5KP36CA	5000	36	40	46	5	6	6	58.1	85	
5KP40A	5KP40CA	5000	40	44.4	51.1	5	6	6	64.5	78	
5KP43A	5KP43CA	5000	43	47.8	54.9	5	6	6	69.4	72	
5KP45A	5KP45CA	5000	45	50	57.5	5	6	6	72.7	69	
5KP48A	5KP48CA	5000	48	53.3	61.3	5	6	6	77.4	65	
5KP51A	5KP51CA	5000	51	56.7	65.2	5	6	6	82.4	61	
5KP54A	5KP54CA	5000	54	60	69	5	6	6	87.1	57	
5KP58A	5KP58CA	5000	58	64.4	74.1	5	6	6	93.6	53	
5KP60A	5KP60CA	5000	60	66.7	76.7	5	6	6	96.8	52	
5KP64A	5KP64CA	5000	64	71.1	81.8	5	6	6	103	49	
5KP70A	5KP70CA	5000	70	77.8	89.5	5	6	6	113	44	
5KP75A	5KP75CA	5000	75	83.3	95.8	5	6	6	121	41	
5KP78A	5KP78CA	5000	78	86.7	99.7	5	6	6	126	40	
5KP85A	5KP85CA	5000	85	94.4	108.2	5	6	6	137	36	
5KP90A	5KP90CA	5000	90	100	115.5	5	6	6	146	34	
5KP100A	5KP100CA	5000	100	111	128	5	6	6	162	31	
5KP110A	5KP110CA	5000	110	122	140.5	5	6	6	177	28	
5KP120A	5KP120CA	5000	120	133	153	5	6	6	193	20	
5KP130A	5KP130CA	5000	130	144	165.5	5	6	6	209	24	
5KP150A	5KP150CA	5000	150	167	192.5	5	6	6	243	21	
5KP160A	5KP160CA	5000	160	178	205	5	6	6	259	19	
5KP170A	5KP170CA	5000	170	189	217.5	5	6	6	275	18	
5KP180A	5KP180CA	5000	180	198	230.4	1	3	3	292	17	
5KP190A	5KP190CA	5000	190	209	243.2	1	3	3	308	16	
5KP200A	5KP200CA	5000	200	220	256	1	3	3	324	15	
5KP210A	5KP210CA	5000	210	231	268.8	1	3	3	340	15	
5KP220A	5KP220CA	5000	220	242	282	1	3	3	356	14	

General Purpose Bipolar

Part Number	Config.	Type	V _{CBO}	V _{CEO}	I _C	V _{CE(sat)}			h _{FE}				P _{TOT}	f _T	Package
			Min.	Min.	Max.	Max.			Min.	Max.	V _{CE}	I _C	Max.	Min.	
			V	V	mA	V	I _C (mA)	I _B (mA)	Min.	Max.	(V)	(mA)	mW	MHz	
BC847BFN3	Single	NPN	50	45	100	0.25	10	0.5	200	450	5	2	250	100	DFN1006-3L
MMBT3904FN3	Single	NPN	60	40	200	0.3	50	5	100	300	1	10	250	-	
MMBT3906FN3	Single	PNP	-40	-40	-200	-0.25	-10	-1	100	300	-1	-10	250	250	
MMBT2222ATB	Single	NPN	75	40	600	0.3	150	15	100	300	10	150	225	-	SOT-523
MMBT3904TB	Single	NPN	60	40	200	0.2	10	1	100	300	1	10	150	-	
MMBT3906TB	Single	PNP	-40	-40	-200	-0.4	-50	-5	100	300	-1	-10	150	-	
BC847BPNTB6	Comple.	NPN/PNP	50	45	100	0.1	10	0.5	200	450	5	2	100	100	SOT-563
MMDT3904TB6	Dual	NPN+NPN	60	40	200	0.3	50	5	100	300	1	10	225	-	
MMDT2222ATB6	Dual	NPN+NPN	75	40	600	0.3	150	15	100	300	10	150	200	300	
MMDT3906TB6	Dual	PNP+PNP	-40	-40	-200	-0.4	-50	-5	100	300	-1	-10	200	-	
MMDT4403TB6	Dual	PNP+PNP	-40	-40	-500	-0.4	-150	-15	90	300	-2	-150	200	200	
BC817-16W	Single	NPN	50	45	500	0.7	500	50	100	250	1	100	300	100	SOT-323
		NPN	50	45	500	0.7	500	50	160	400	1	100	300	100	
BC817-40W	Single	NPN	50	45	500	0.7	500	50	250	600	1	100	300	100	
		NPN	80	65	100	0.25	10	0.5	110	220	5	2	250	100	
BC846BW	Single	NPN	80	65	100	0.25	10	0.5	200	450	5	2	250	-	
BC847AW	Single	NPN	50	45	100	0.25	10	0.5	110	220	5	2	250	-	
BC847BW	Single	NPN	50	45	100	0.25	10	0.5	200	450	5	2	250	-	
BC847CW	Single	NPN	50	45	100	0.25	10	0.5	420	800	5	2	250	-	
BC848AW	Single	NPN	30	30	100	0.25	10	0.5	110	220	5	2	250	-	
BC848BW	Single	NPN	30	30	100	0.25	10	0.5	200	450	5	2	250	-	
BC848CW	Single	NPN	30	30	100	0.25	10	0.5	420	800	5	2	250	-	
BC849BW	Single	NPN	30	30	100	0.25	10	0.5	200	450	5	2	250	-	
BC849CW	Single	NPN	30	30	100	0.25	10	0.5	420	800	5	2	250	-	
BC850BW	Single	NPN	50	45	100	0.25	10	0.5	200	450	5	2	250	-	
BC850CW	Single	NPN	50	45	100	0.25	10	0.5	420	800	5	2	250	-	
BC817-25W	Single	NPN	50	45	500	0.7	500	50	160	400	1	100	300	100	
MMBT2222AW	Single	NPN	75	40	600	0.3	150	15	100	300	10	150	150	-	
MMBT3904W	Single	NPN	60	40	200	0.3	50	5	100	300	1	10	150	-	
MMBT4401W	Single	NPN	60	40	600	0.4	150	15	100	300	1	150	225	250	
BC846AW	Single	NPN	80	65	100	0.25	10	0.5	110	220	5	2	250	-	
MMBTA06W	Single	NPN	80	80	500	0.25	100	10	100	-	1	100	225	100	
MMBT5551W	Single	NPN	180	160	600	0.15	10	1	80	250	5	10	250	100	
MMBTA42W	Single	NPN	300	300	500	0.5	20	2	25	-	10	1	150	50	
BC807-16W	Single	PNP	-50	-45	-500	-0.7	-500	-50	100	250	-1	-100	300	100	
BC807-25W	Single	PNP	-50	-45	-500	-0.7	-500	-50	160	400	-1	-100	300	100	
BC807-40W	Single	PNP	-50	-45	-500	-0.7	-500	-50	250	600	-1	-100	300	100	
BC856AW	Single	PNP	-80	-65	-100	-0.3	-10	-0.5	125	250	-5	-2	250	-	
BC856BW	Single	PNP	-80	-65	-100	-0.3	-10	-0.5	220	475	-5	-2	250	-	
BC857AW	Single	PNP	-50	-45	-100	-0.3	-10	-0.5	125	250	-5	-2	250	-	
BC857BW	Single	PNP	-50	-45	-100	-0.3	-10	-0.5	220	475	-5	-2	250	-	
BC857CW	Single	PNP	-50	-45	-100	-0.3	-10	-0.5	420	800	-5	-2	250	-	
BC858AW	Single	PNP	-30	-30	-100	-0.3	-10	-0.5	125	250	-5	-2	250	-	
BC858BW	Single	PNP	-30	-30	-100	-0.3	-10	-0.5	220	475	-5	-2	250	-	
BC858CW	Single	PNP	-30	-30	-100	-0.3	-10	-0.5	420	800	-5	-2	250	-	
BC859BW	Single	PNP	-30	-30	-100	-0.3	-10	-0.5	220	475	-5	-2	250	-	
BC859CW	Single	PNP	-30	-30	-100	-0.3	-10	-0.5	420	800	-5	-2	250	-	
MMBT2907AW	Single	PNP	-60	-60	-600	-0.4	-150	-15	100	300	-10	-150	150	200	
MMBT3906W	Single	PNP	-40	-40	-200	-0.4	-50	-5	100	300	-1	-10	150	250	
MMBT4403W	Single	PNP	-40	-40	-600	-0.4	-150	-15	100	300	-2	-150	225	200	
MMBTA92W	Single	PNP	-300	-300	-500	-0.5	-20	-2	25	-	-10	-1	150	50	
DMMT3906W	Dual	PNP+PNP	-40	-40	-200	-0.4	-50	-5	100	300	-1	-10	225	250	

General Purpose Bipolar

Part Number	Config.	Type	V _{CB0}	V _{CE0}	I _C	V _{CE(sat)}			h _{FE}				P _{TOT}	f _T	Package
			Min.	Min.	Max.	Max.			Min.	Max.	V _{CE}	I _C	Max.	Min.	
			V	V	mA	V	I _C (mA)	I _B (mA)	Min.	Max.	(V)	(mA)	mW	MHz	
BC846APN	Comple.	NPN	80	65	100	0.25	10	0.5	110	220	5	2	225	-	SOT-363
		PNP	-80	-65	-100	-0.3	-10	-0.5	110	220	-5	-2	225	100	
BC846AS	Dual	NPN+NPN	80	65	100	0.25	10	0.5	110	220	5	2	150	-	
BC846BPN	Comple.	NPN	80	65	100	0.25	10	0.5	200	450	5	2	225	100	
		PNP	-80	-65	-100	-0.3	-10	-0.5	220	475	-5	-2	225	100	
BC846BS	Dual	NPN+NPN	80	65	100	0.1	10	0.5	200	450	5	2	250	-	
BC847AS	Dual	NPN+NPN	50	45	100	0.1	10	0.5	110	220	5	2	150	-	
BC847BPN	Comple.	NPN	50	45	100	0.25	10	0.5	200	450	5	2	200	100	
		PNP	-50	-45	-100	-0.3	-10	-0.5	200	475	-5	-2	200	100	
BC847BS	Dual	NPN+NPN	50	45	100	0.25	10	0.5	200	450	5	2	150	100	
BC847CPN	Comple.	NPN	50	45	100	0.25	10	0.5	420	800	5	2	380	100	
		PNP	-50	-45	-100	-0.3	-10	-0.5	420	800	-5	-2	380	100	
BC847CS	Dual	NPN+NPN	50	45	100	0.25	10	0.5	420	800	5	2	150	-	
BC856BS	Dual	PNP+PNP	-80	-65	-100	-0.3	-10	-0.5	220	475	-5	-2	150	-	
BC857BS	Dual	PNP+PNP	-50	-45	-100	-0.3	-10	-0.5	220	475	-5	-2	300	100	
BC857CS	Dual	PNP+PNP	-50	-45	-100	-0.3	-10	-0.5	420	800	-5	-2	225	-	
DMMT3904W	Dual	NPN+NPN	60	40	200	0.3	50	5	100	300	1	10	225	300	
DMMT3906	Dual	PNP+PNP	-40	-40	-200	-0.4	-50	-5	100	300	-1	-10	225	250	
MMDT2222A	Dual	NPN+NPN	75	40	600	0.3	150	15	100	300	10	150	225	300	
MMDT2227A	Comple.	NPN	75	40	600	0.3	150	15	100	300	10	150	225	300	
		PNP	-60	-60	-600	-0.4	-150	-15	100	300	-10	-150	225	200	
MMDT2907AQ	Dual	PNP+PNP	-60	-60	-600	-0.4	-150	-15	100	300	-10	-150	150	200	
MMDT3904	Dual	NPN+NPN	60	40	200	0.3	50	5	100	300	1	10	225	-	
MMDT3906	Dual	PNP+PNP	-40	-40	-200	-0.4	-50	-5	100	300	-1	-10	225	-	
MMDT3946	Comple.	NPN	60	40	200	0.3	50	5	100	300	1	10	225	-	
		PNP	-40	-40	-200	-0.4	-50	-5	100	300	-1	-10	225	300	
MMDT4401	Dual	NPN+NPN	60	40	600	0.4	150	15	100	300	1	150	225	250	
MMDT4403	Dual	PNP+PNP	-60	-40	-600	-0.4	-150	-15	100	300	-2	-150	225	200	
MMDT4413	Comple.	NPN	60	40	600	0.3	150	15	100	300	1	150	225	250	
		PNP	-40	-40	-600	-0.4	-150	-15	100	300	-2	-150	225	200	
MMDT5551	Dual	NPN+NPN	180	160	600	0.15	10	1	80	250	5	10	250	100	

General Purpose Bipolar

Part Number	Config.	Type	V _{CBO}	V _{CEO}	I _C	V _{CE(sat)}			h _{FE}				P _{TOT}	f _T	Package	
			Min.	Min.	Max.	Max.			Min.	Max.	V _{CE}	I _C	Max.	Min.		
			V	V	mA	V	I _C (mA)	I _B (mA)	Min.	Max.	(V)	(mA)	mW	MHz		
2SC2411K	Single	NPN	40	32	500	0.6	500	50	120	390	3	100	225	250	SOT-23	
BC817-16	Single	NPN	50	45	500	0.7	500	50	100	250	1	100	300	100		
BC817-25	Single	NPN	50	45	500	0.7	500	50	160	400	1	100	300	100		
BC817-40	Single	NPN	50	45	500	0.7	500	50	250	600	1	100	300	100		
BC846A	Single	NPN	80	65	100	0.25	10	0.5	110	220	5	2	330	-		
BC846B	Single	NPN	80	65	100	0.25	10	0.5	200	450	5	2	330	-		
BC847A	Single	NPN	50	45	100	0.25	10	0.5	110	220	5	2	330	-		
BC847B	Single	NPN	50	45	100	0.25	10	0.5	200	450	5	2	330	-		
BC847C	Single	NPN	50	45	100	0.25	10	0.5	420	800	5	2	330	-		
BC848A	Single	NPN	30	30	100	0.25	10	0.5	110	220	5	2	330	-		
BC848B	Single	NPN	30	30	100	0.25	10	0.5	200	450	5	2	330	-		
BC848C	Single	NPN	30	30	100	0.25	10	0.5	420	800	5	2	330	-		
BC849B	Single	NPN	30	30	100	0.25	10	0.5	200	450	5	2	330	-		
BC849C	Single	NPN	30	30	100	0.25	10	0.5	420	800	5	2	330	-		
BC850B	Single	NPN	50	45	100	0.25	10	0.5	200	450	5	2	330	-		
BC850C	Single	NPN	50	45	100	0.25	10	0.5	420	800	5	2	330	-		
MMBT2222A	Single	NPN	75	40	600	0.3	150	15	100	300	10	150	225	-		
MMBT2369A	Single	NPN	40	15	200	0.2	10	1	40	120	1	10	225	-		
MMBT3904	Single	NPN	60	40	200	0.3	50	5	100	300	1	10	225	-		
MMBT4401	Single	NPN	60	40	600	0.4	150	15	100	300	1	150	225	250		
MMBT5551	Single	NPN	180	160	600	0.15	10	1	80	250	5	10	250	100		
MMBT918	Single	NPN	30	15	50	0.4	10	1	20	-	1	3	225	600		
MMBTA05	Single	NPN	60	60	500	0.25	100	10	100	-	1	100	225	100		
MMBTA06	Single	NPN	80	80	500	0.25	100	10	100	-	1	100	225	100		
MMBTA42	Single	NPN	300	300	500	0.5	20	2	40	-	10	30	250	50		
MMBTA44	Single	NPN	400	400	300	0.75	50	5	50	200	10	10	225	50		
BC807-16	Single	PNP	-50	-45	-500	-0.7	-500	-50	100	250	-1	-100	330	100		
BC807-25	Single	PNP	-50	-45	-500	-0.7	-500	-50	160	400	-1	-100	330	100		
BC807-40	Single	PNP	-50	-45	-500	-0.7	-500	-50	250	600	-1	-100	330	100		
BC856A	Single	PNP	-80	-65	-100	-0.3	-10	-0.5	125	250	-5	-2	330	-		
BC856B	Single	PNP	-80	-65	-100	-0.3	-10	-0.5	220	475	-5	-2	330	-		
BC857A	Single	PNP	-50	-45	-100	-0.3	-10	-0.5	125	250	-5	-2	330	-		
BC857B	Single	PNP	-50	-45	-100	-0.3	-10	-0.5	220	475	-5	-2	330	-		
BC857C	Single	PNP	-50	-45	-100	-0.3	-10	-0.5	420	800	-5	-2	330	-		
BC858A	Single	PNP	-30	-30	-100	-0.3	-10	-0.5	110	220	-5	-2	330	-		
BC858B	Single	PNP	-30	-30	-100	-0.3	-10	-0.5	220	475	-5	-2	330	-		
BC858C	Single	PNP	-30	-30	-100	-0.3	-10	-0.5	420	800	-5	-2	330	-		
BC859B	Single	PNP	-30	-30	-100	-0.3	-10	-0.5	220	475	-5	-2	330	-		
BC859C	Single	PNP	-30	-30	-100	-0.3	-10	-0.5	420	800	-5	-2	330	-		
MMBT2907A	Single	PNP	-60	-60	-600	-0.4	-150	-15	100	300	-10	-150	150	200		
MMBT3906	Single	PNP	-40	-40	-200	-0.4	-50	-5	100	300	-1	-10	225	250		
MMBT4403	Single	PNP	-40	-40	-600	-0.4	-150	-15	100	300	-2	-150	225	200		
MMBT5401	Single	PNP	-160	-150	-500	-0.5	-50	-5	60	240	-10	-5	225	100		
MMBTA55	Single	PNP	-60	-60	-500	-0.25	-100	-10	100	-	-1	-100	225	100		
MMBTA56	Single	PNP	-80	-80	-500	-0.25	-100	-10	100	-	-1	-100	225	100		
MMBTA92	Single	PNP	-300	-300	-500	-0.5	-20	-2	25	-	-10	-30	225	50		
2SC164S	Asym.	NPN+DT NPN	60	40	200	0.2	10	1	100	300	1	10	1000	300		SOT-23 6L
BC817DS-25	Dual	NPN+NPN	50	45	500	0.7	500	50	160	400	1	100	330	100		
BC817DPN	Comple.	NPN	50	45	500	0.7	500	50	100	600	1	100	330	100		
		PNP	-50	-45	-500	-0.7	-500	-50	100	600	-1	-100	330	100		
BC817DPN-25	Comple.	NPN	50	45	500	0.7	500	50	160	400	1	100	330	100		
		PNP	-50	-45	-500	-0.7	-500	-50	160	400	-1	-100	330	100		
IMZ1AS	Comple.	NPN	50	60	150	0.4	50	5	120	560	6	1	300	-		
		PNP	-50	-60	-150	-0.5	-50	-5	120	560	-6	-1	300	-		
IMZ2A	Comple.	NPN	60	50	150	0.4	50	5	120	560	6	1	300	-		
		PNP	-60	-50	-150	-0.5	-50	-5	120	560	-6	-1	300	-		

Low VCE(sat) Transistor

Part Number	Config.	Type	V _{CB0}	V _{CEO}	I _C	V _{CE(sat)}			h _{FE}				P _{TOT}	f _T	Package
			Max.	Max.	Max.	Max.	I _C	I _B	Min.	Max.	V _{CE}	I _C	Max.	Min.	
			V	V	mA	V	I _C (mA)	I _B (mA)			(V)	(mA)	mW	MHz	
PBSS4140SW	NPN	Single	40	40	1000	0.25	1000	100	300	900	5	500	1400	150	SOT-223
PBHV8110DW	NPN	Single	120	100	1000	0.45	1000	100	100	300	5	500	2600	100	
PBHV9110DW	PNP	Single	-120	-100	-1000	-0.6	-1000	-100	100	300	-5	-500	2600	100	
PBHV8050SA	NPN	Single	500	500	150	0.2	20	2	150	300	10	1	500	50	SOT-23
PBHV8110DA	NPN	Single	120	100	1000	0.45	1000	100	100	300	5	500	1250	100	
PBHV9110DA	PNP	Single	-120	-100	-1000	-0.6	-1000	-100	100	300	-5	-500	1250	100	
2SD1781A	NPN	Single	100	50	3000	0.14	1000	100	300	900	5	500	1250	250	
2SB1197A	PNP	Single	-50	-50	-3000	-0.2	-1000	-100	100	300	-2	-500	1250	180	
2SB1429	PNP	Single	-20	-20	-3000	-0.3	-3000	-0.3	200	500	-2	-500	1250	160	
PBSS4140SH	NPN	Single	40	40	1000	0.25	1000	100	300	900	5	500	1400	150	SOT-89
PBHV8110DH	NPN	Single	120	100	1000	0.45	1000	100	100	300	5	500	1400	100	
PBHV9110DH	PNP	Single	-120	-100	-1000	-0.6	-1000	-100	100	300	-5	-500	1400	100	
PBSS4232DD	NPN	Single	40	32	2000	0.4	1000	100	180	390	3	500	2000	270	TO-252AA

Outline Drawing and Minimum Pad Layout

DFN0603-2L

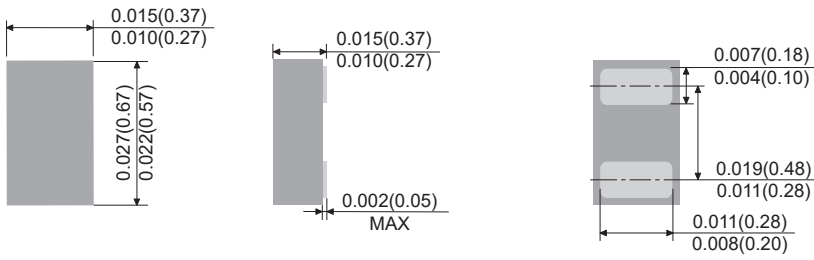

DFN0603-2L

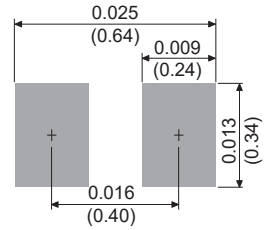

DFN1006-2L

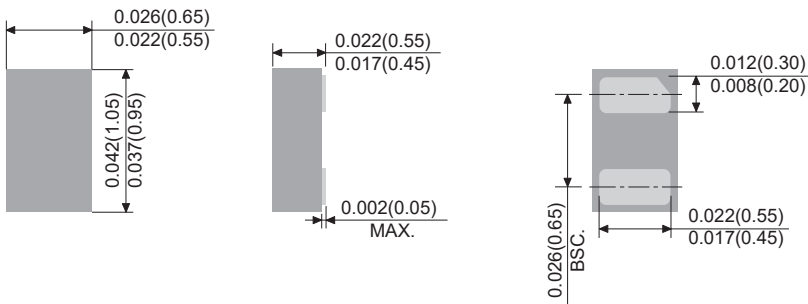

DFN1006-2L

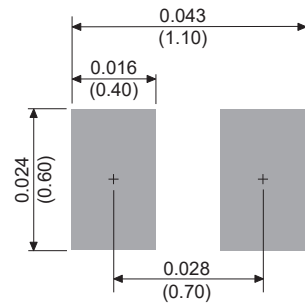

DFN1006-3L

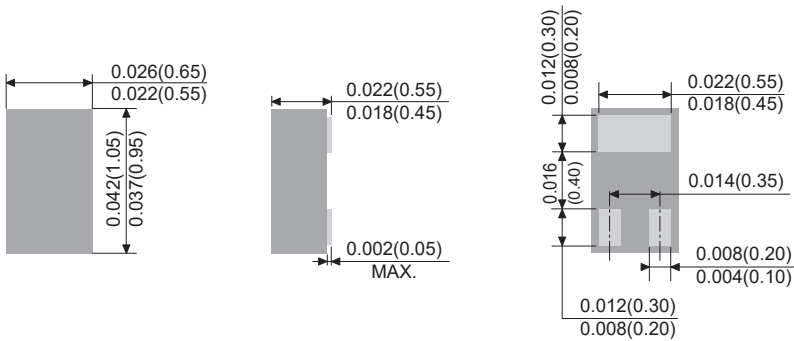

DFN1006-3L

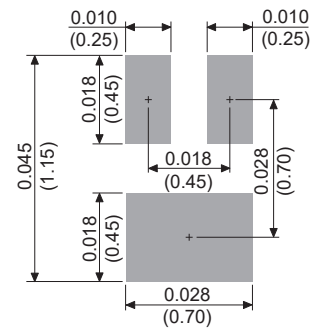

DFN1610-2L

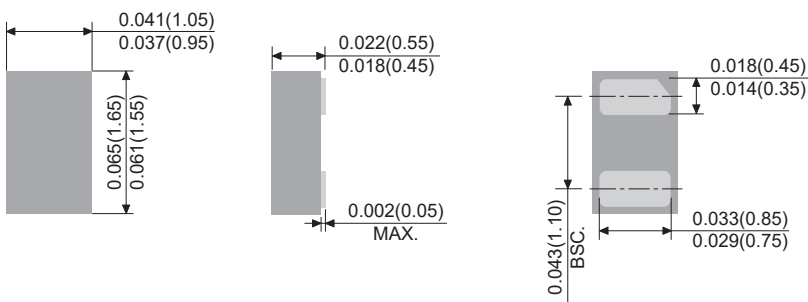

DFN1610-2L

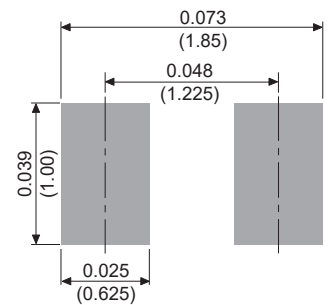

Unit: inch (mm)

Outline Drawing and Minimum Pad Layout

DFN1010B-6L

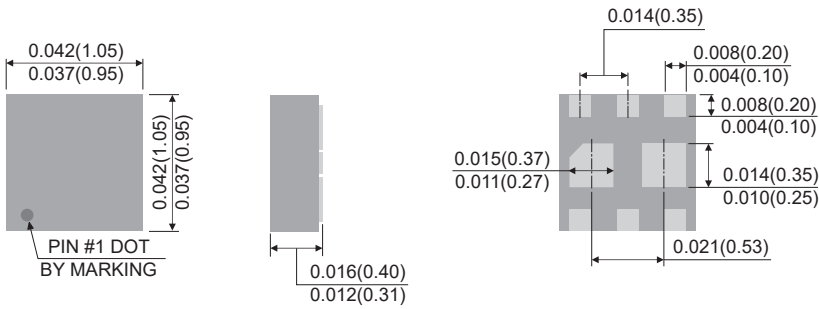

DFN1010B-6L

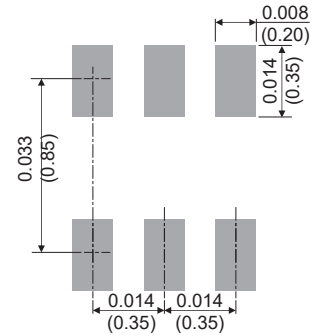

DFN2020-6L

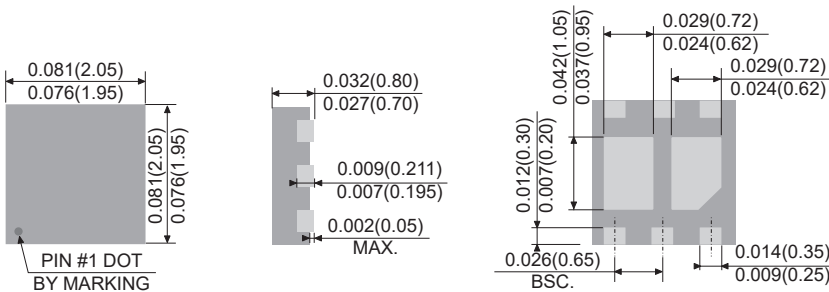

DFN2020-6L

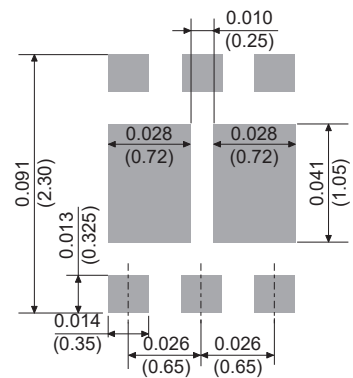

DFN2020B-6L

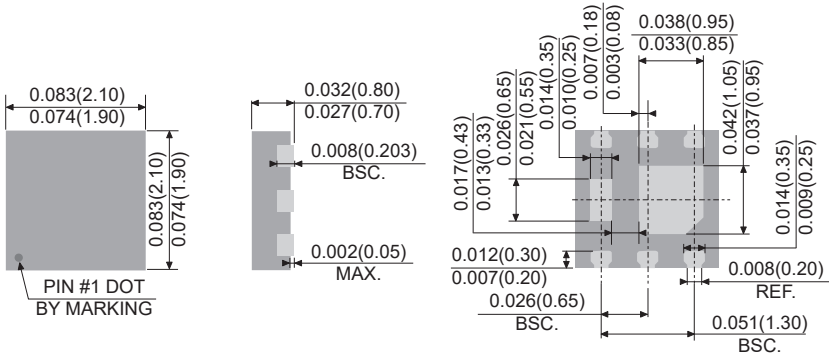

DFN2020B-6L

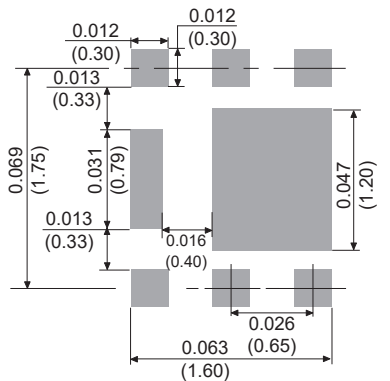

DFN2020-8L

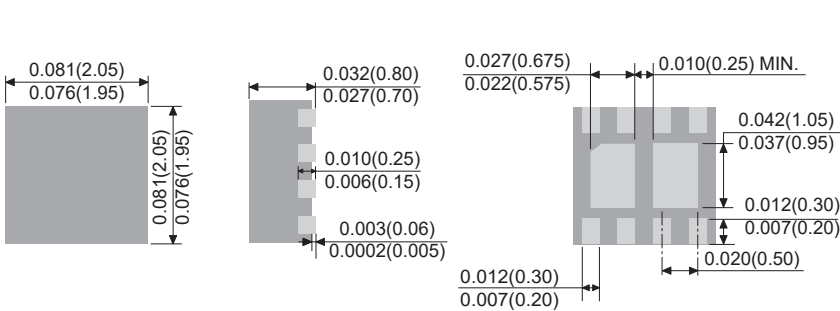

DFN2020-8L

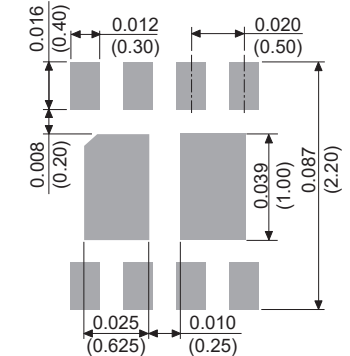

Unit: inch (mm)

Outline Drawing and Minimum Pad Layout

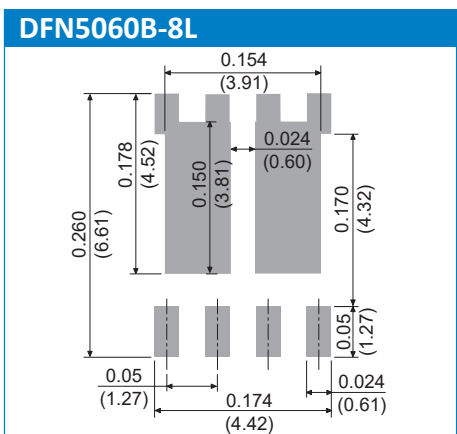
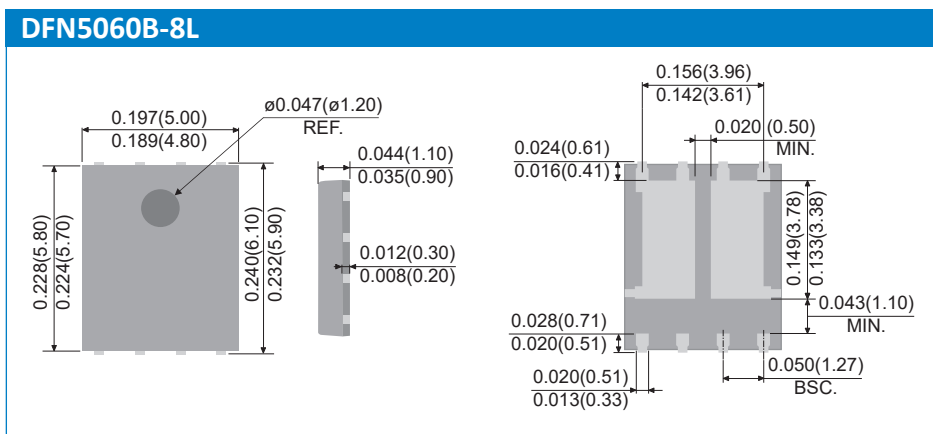
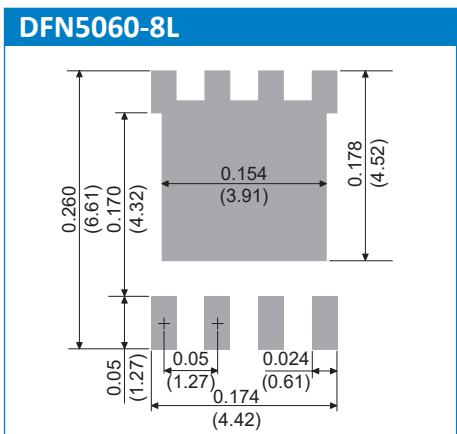
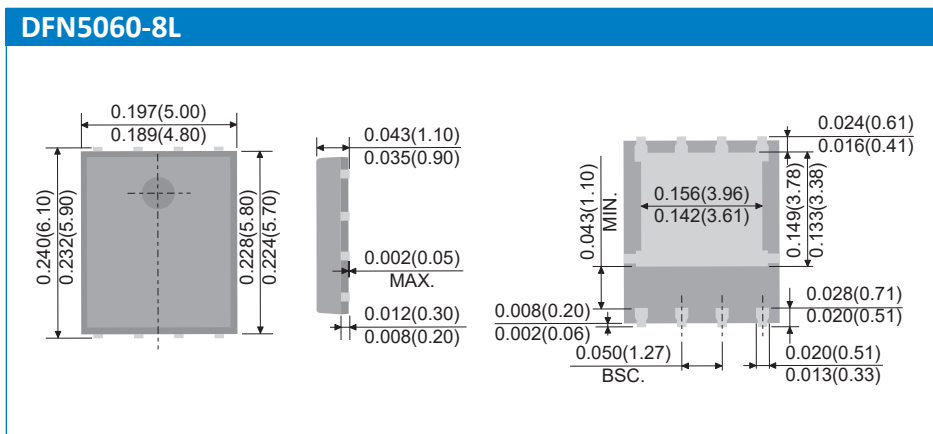
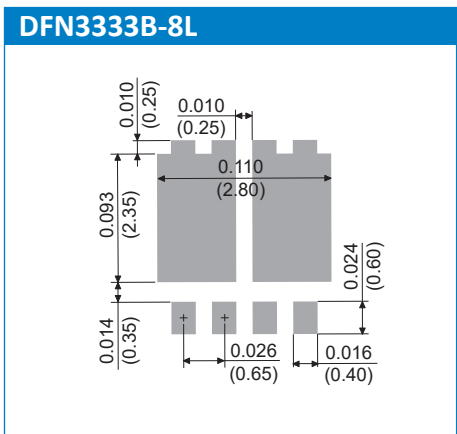
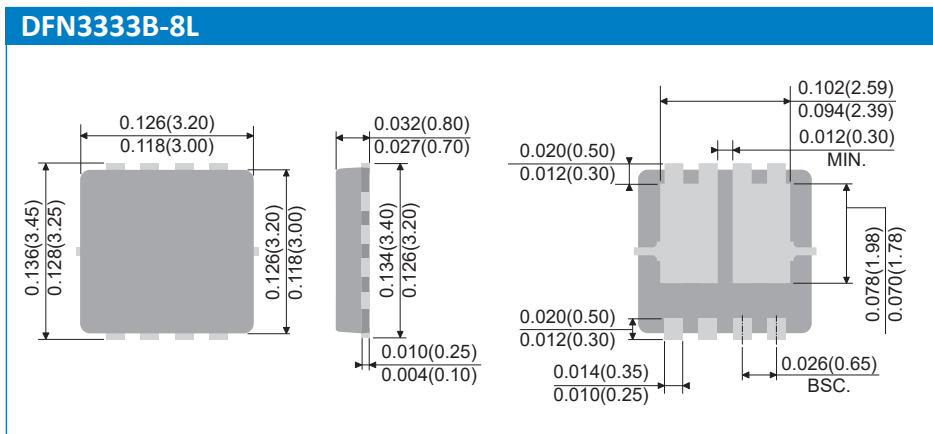
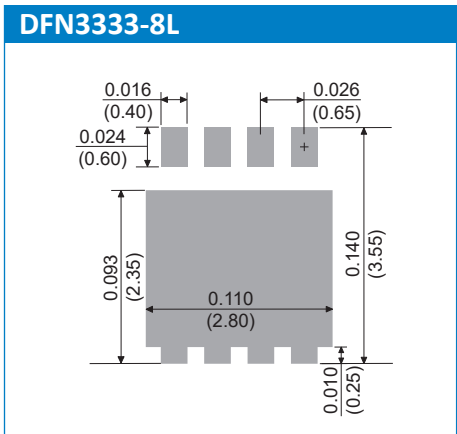
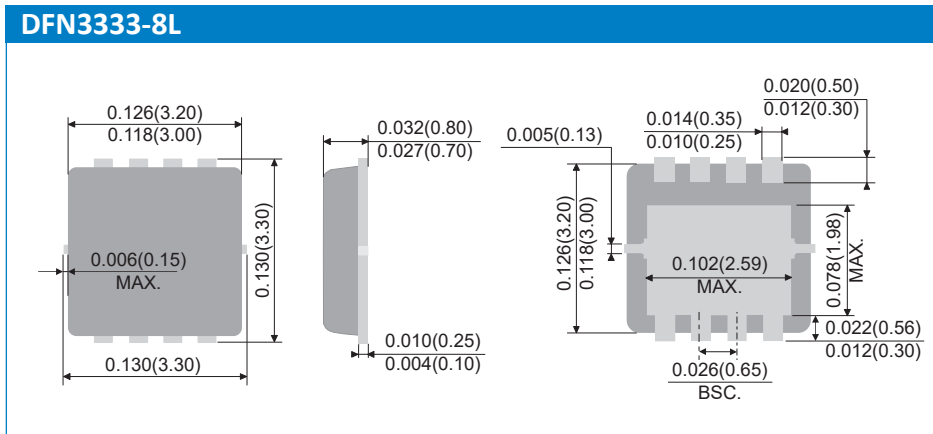

Unit: inch (mm)

Outline Drawing and Minimum Pad Layout

DFN5060X-8L

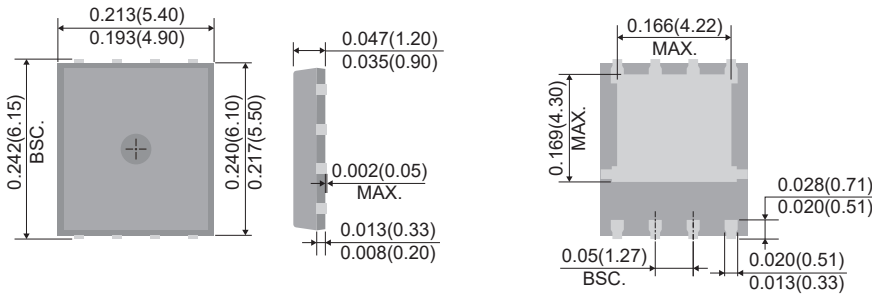

DFN5060X -8L

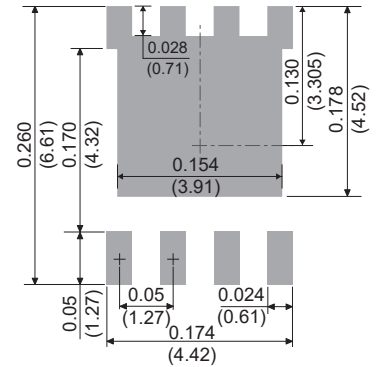

DFN2510-10L

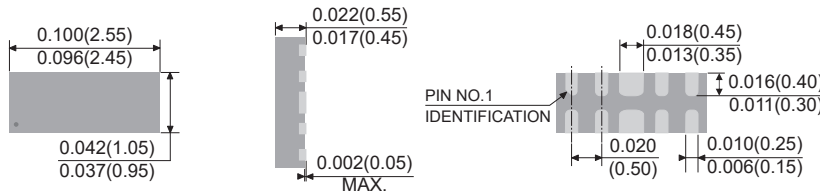

DFN2510-10L

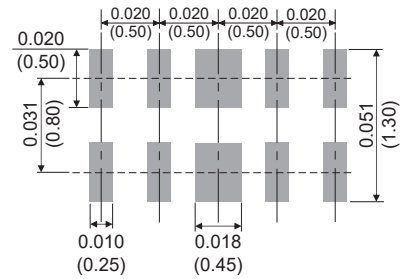

DFN2510A-10L

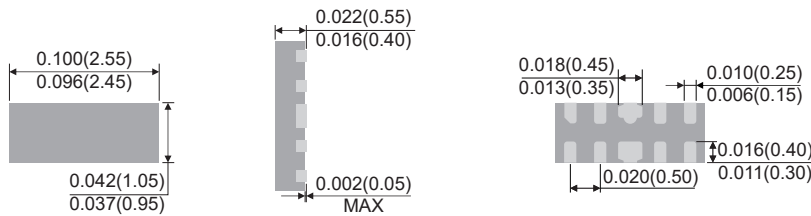

DFN2510A-10L

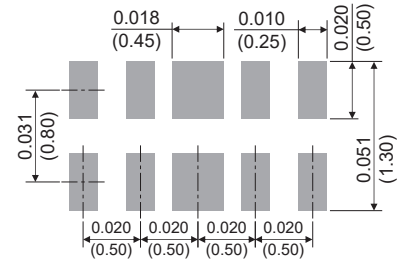

DFN3810-9L

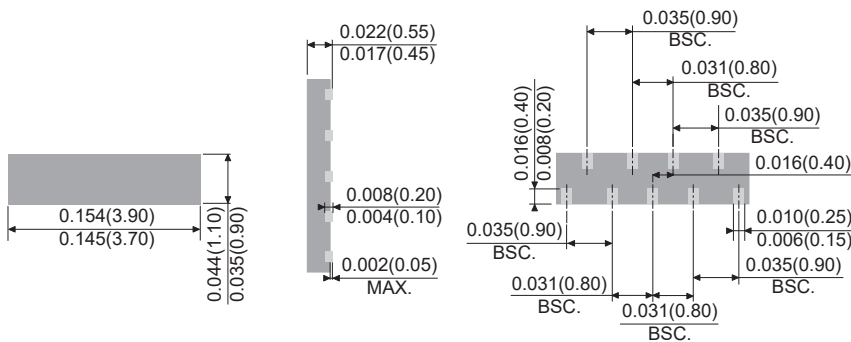

DFN3810-9L

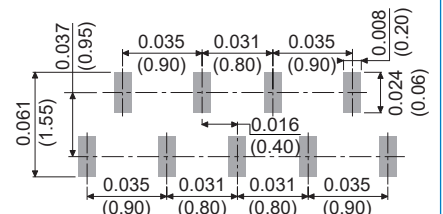

Unit: inch (mm)

Outline Drawing and Minimum Pad Layout

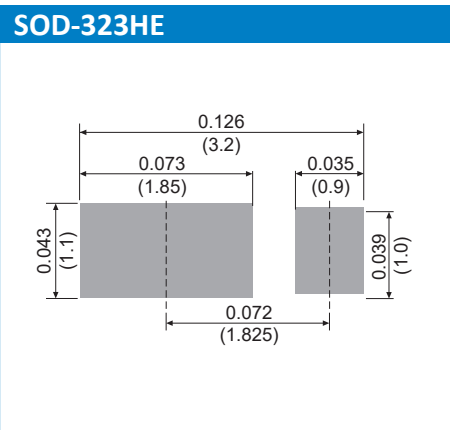
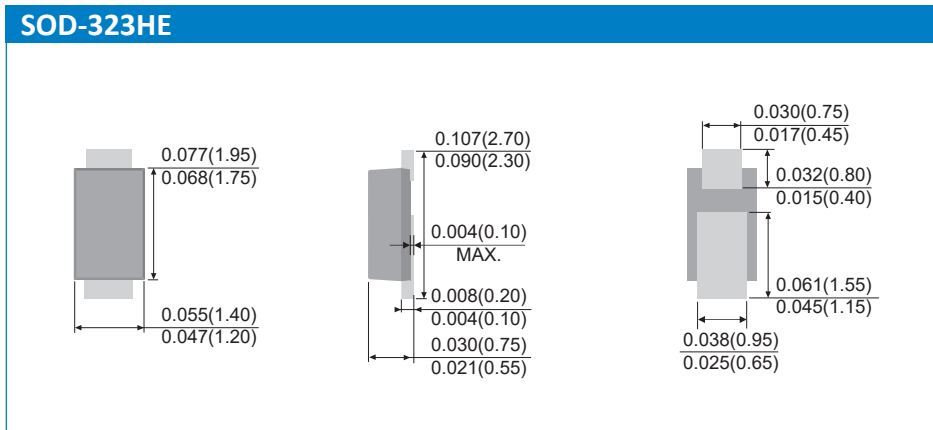
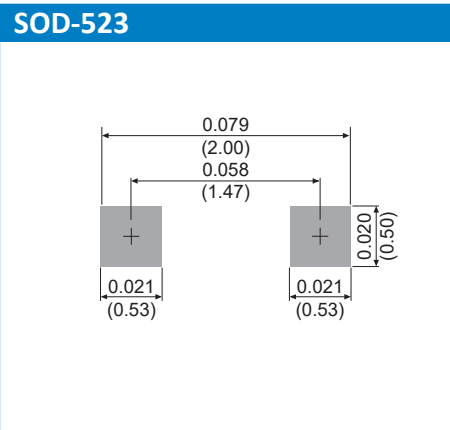
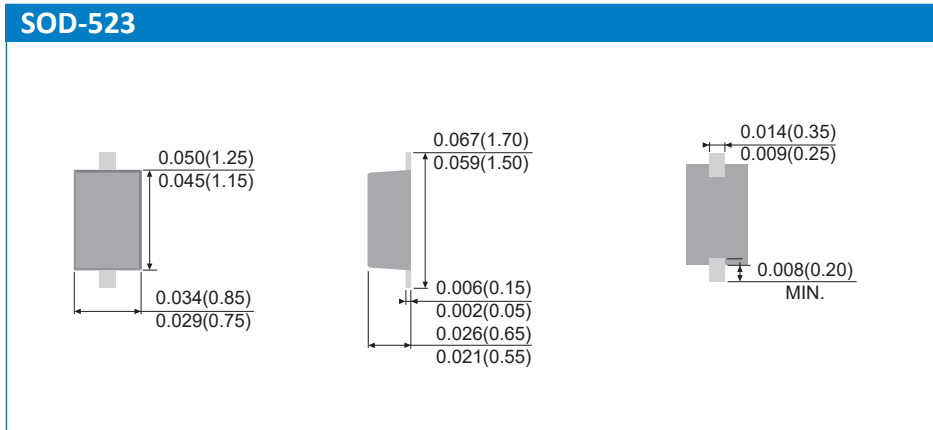
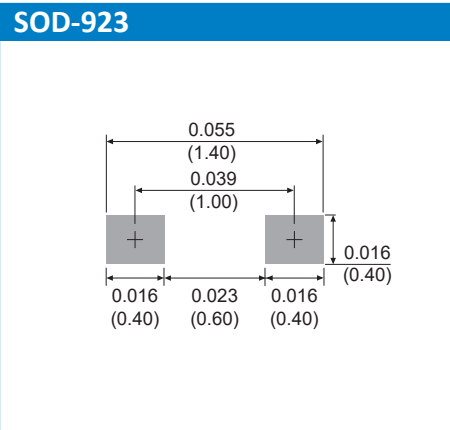
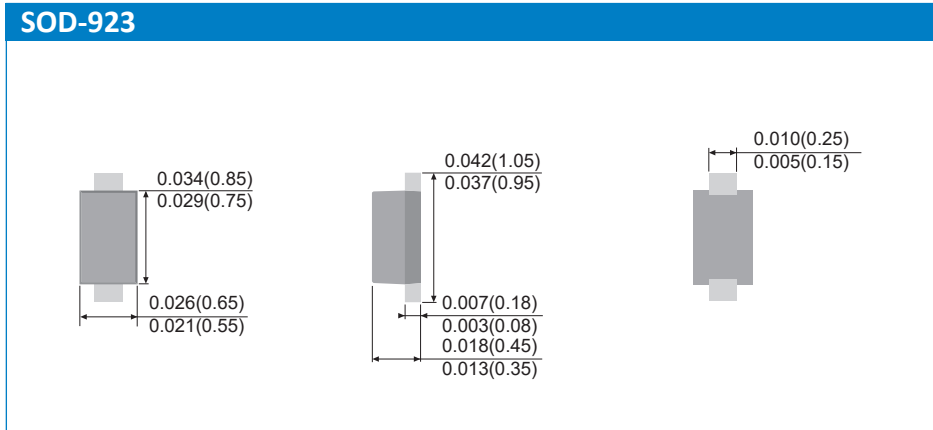
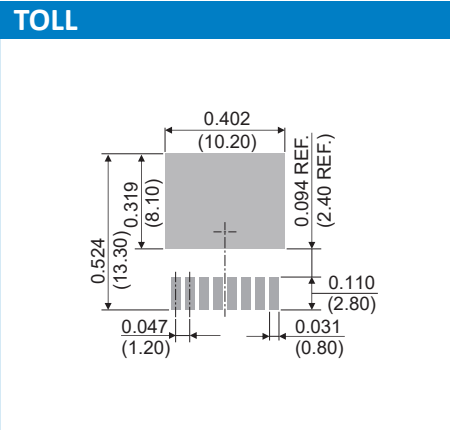
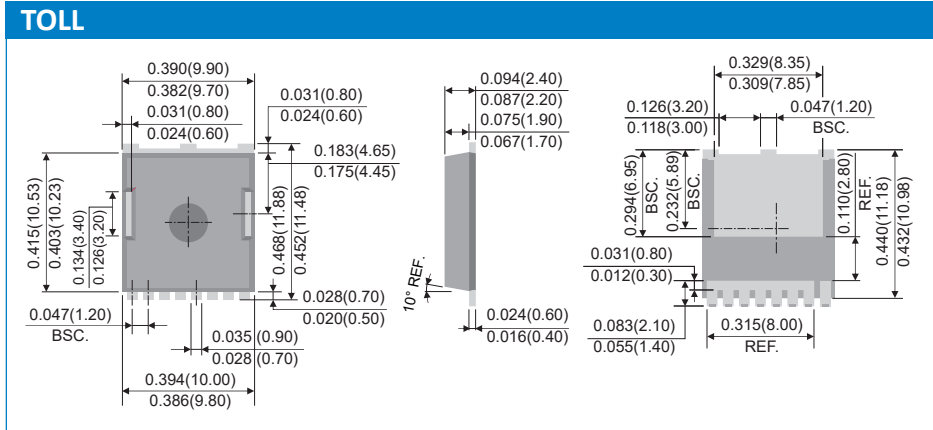

Unit: inch (mm)

Outline Drawing and Minimum Pad Layout

SOD-323

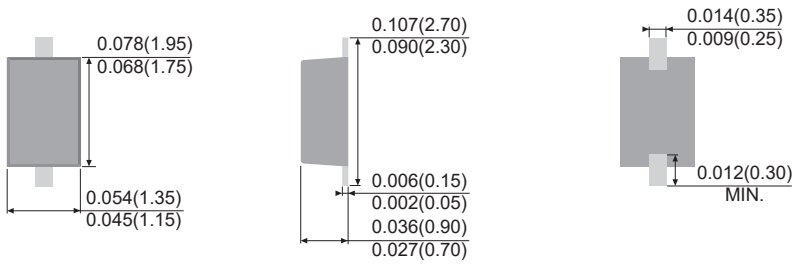

SOD-323

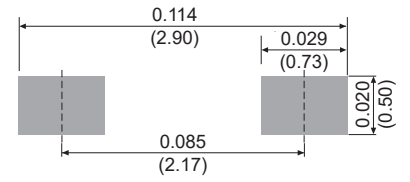

SOD-323S

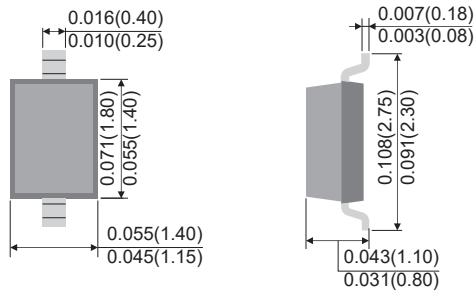

SOD-323S

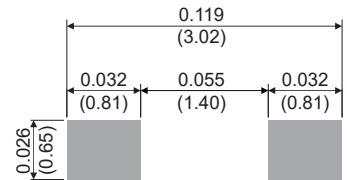

SOD-123HE

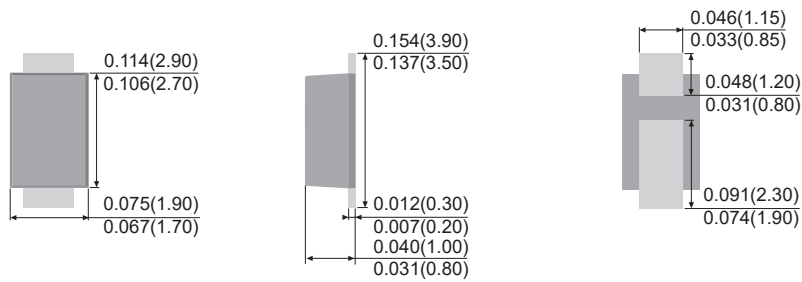

SOD-123HE

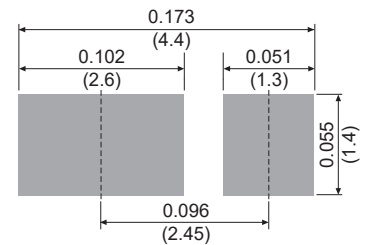

SOD-123FL

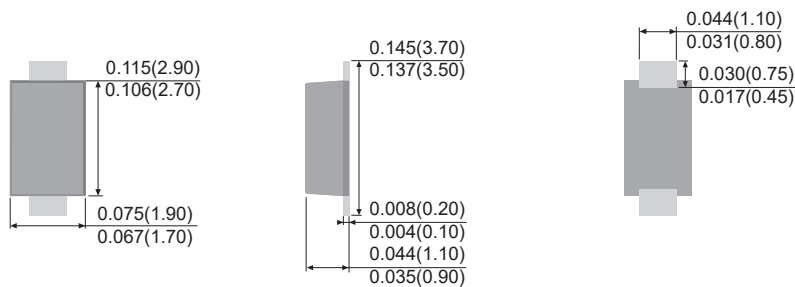

SOD-123FL

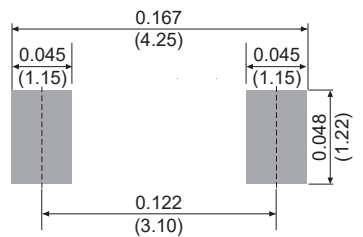

Unit: inch (mm)

Outline Drawing and Minimum Pad Layout

SOD-123

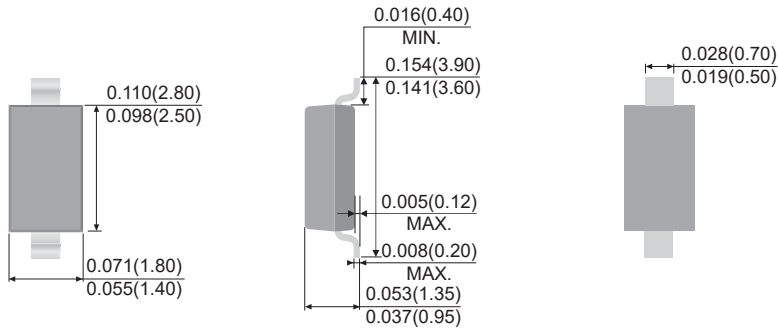

SOD-123

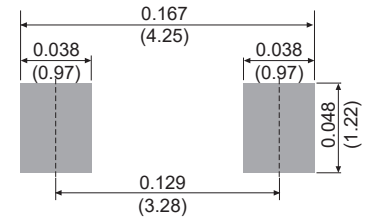

SOT-723

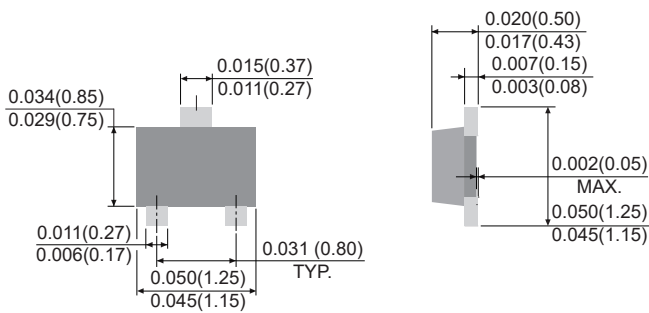

SOT-723

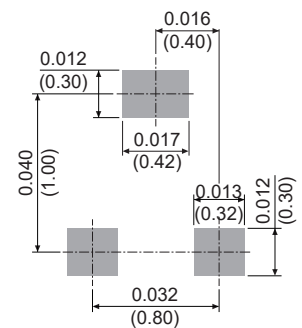

SOT-563

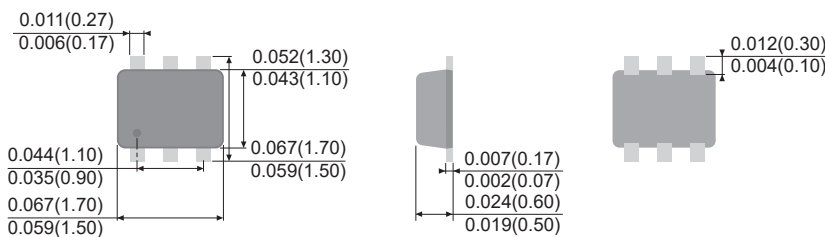

SOT-563

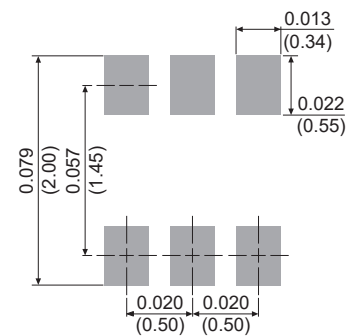

SOT-523

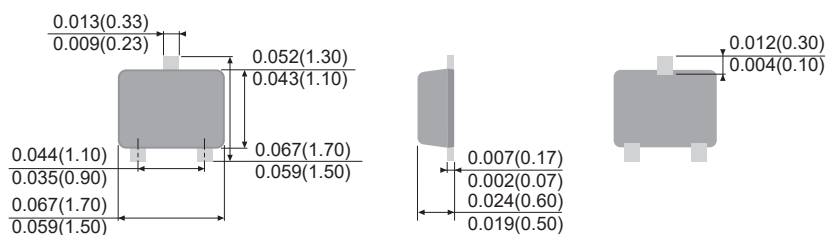

SOT-523

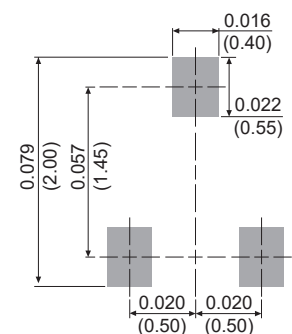

Unit: inch (mm)

Outline Drawing and Minimum Pad Layout

SOT-363

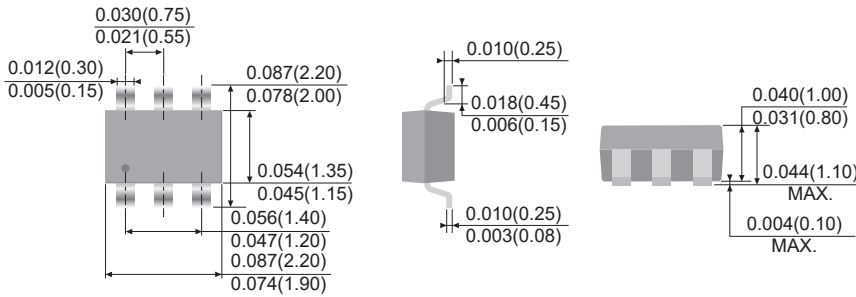

SOT-363

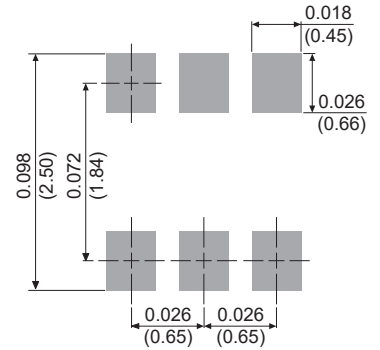

SOT-323

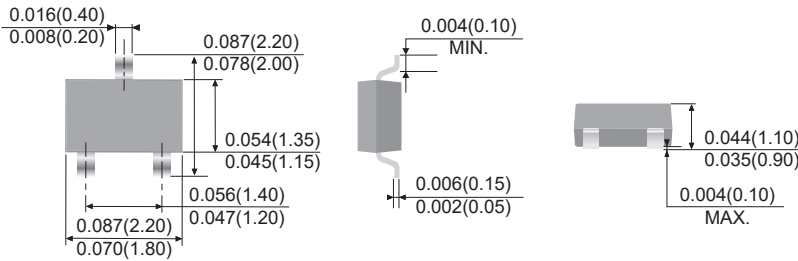

SOT-323

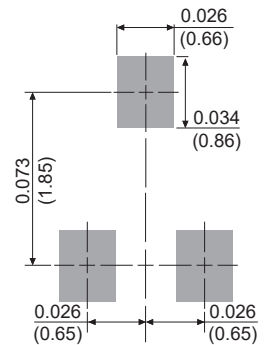

SOT-23

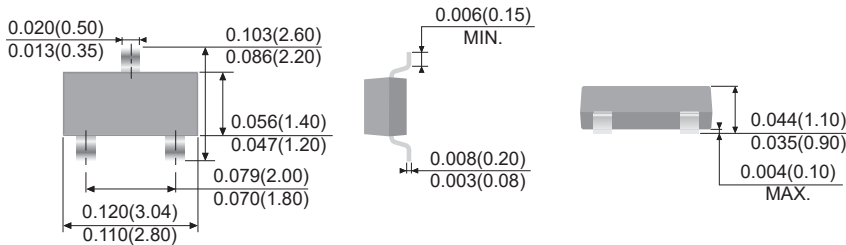

SOT-23

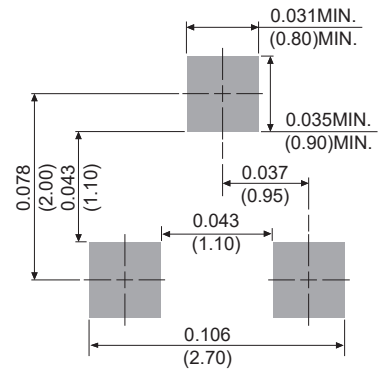

SOT-23 6L

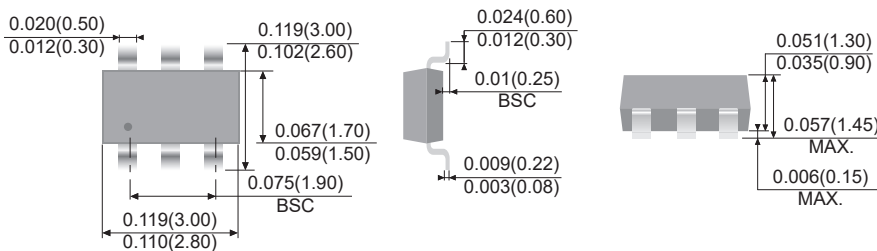

SOT-23 6L

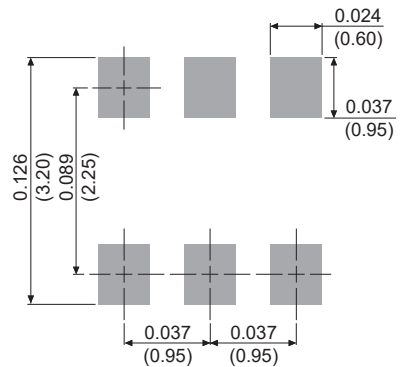

Unit: inch (mm)

Outline Drawing and Minimum Pad Layout

SOT-23 6L-1/SOT-26-1

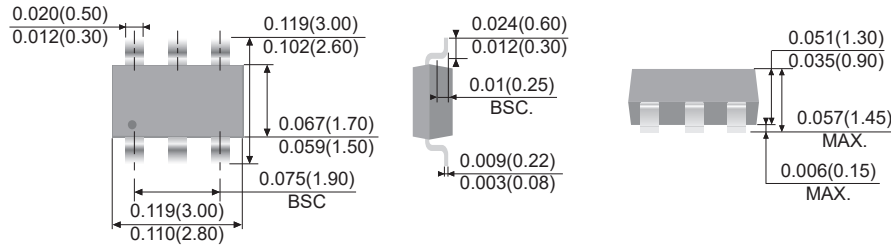

SOT-23 6L-1/SOT-26-1

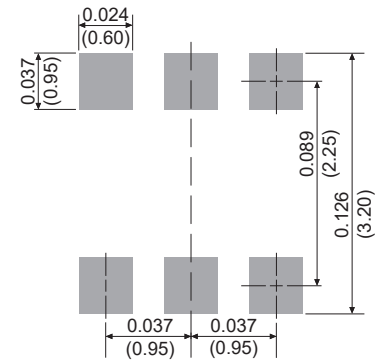

TSSOP-18

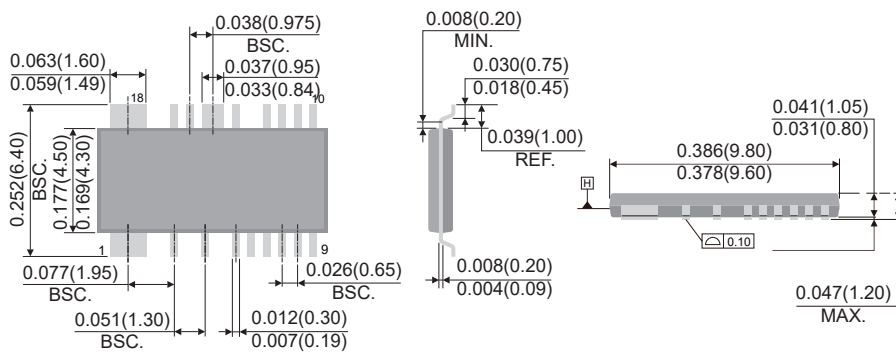

TSSOP-18

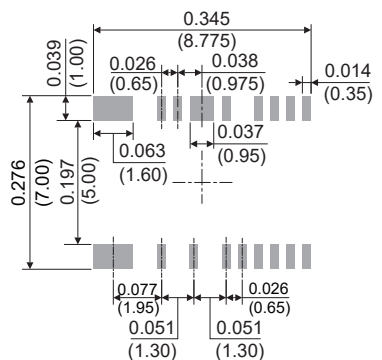

SOT-223

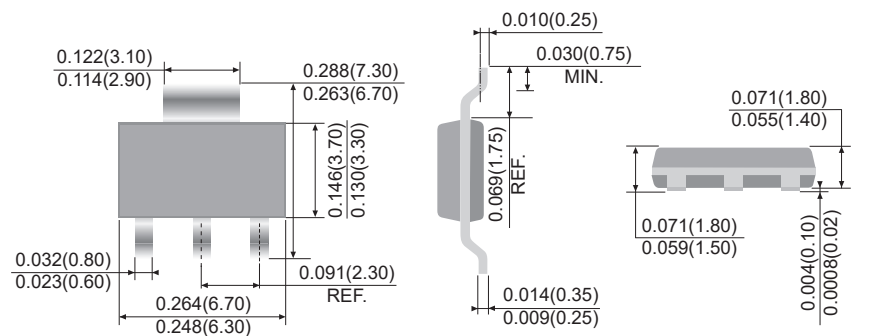

SOT-223

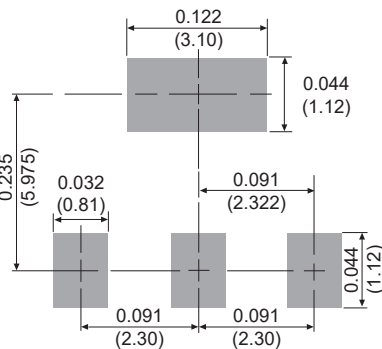

SOT-89

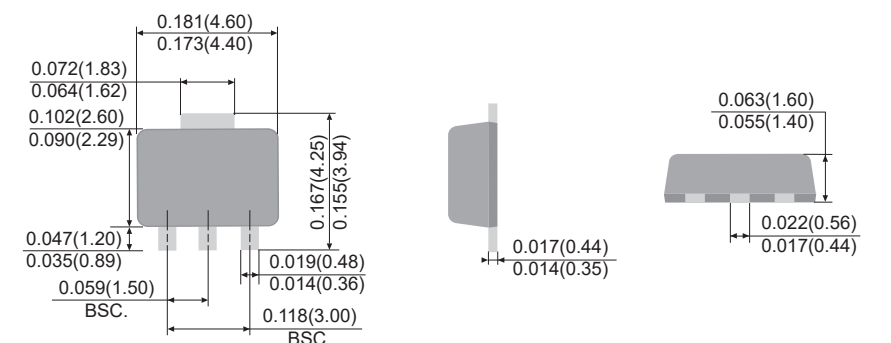

SOT-89

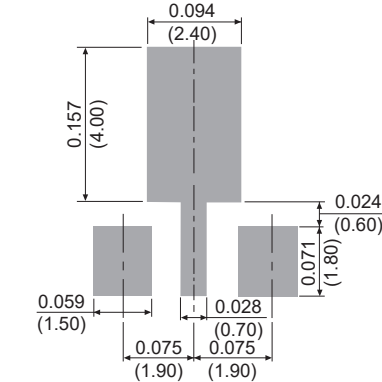

Unit: inch (mm)

Outline Drawing and Minimum Pad Layout

SMAF-C

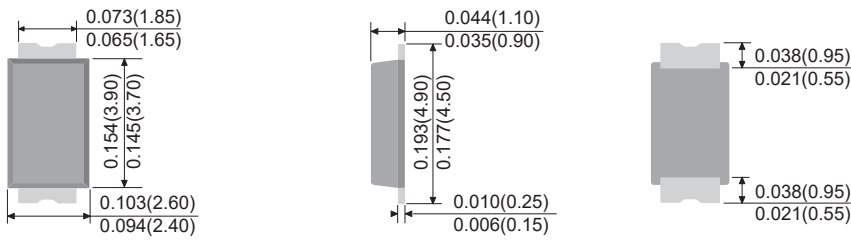

SMAF-C

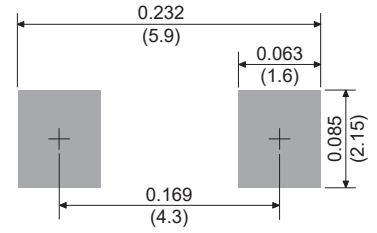

SMA

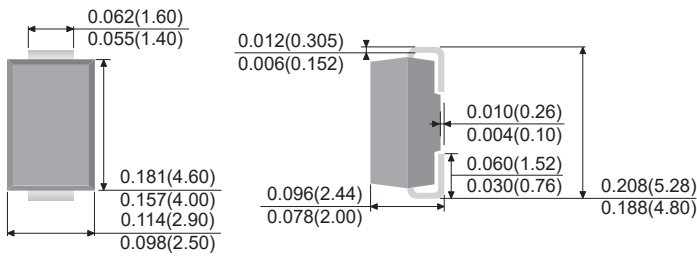

SMA

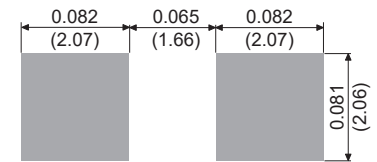

SMA(W)

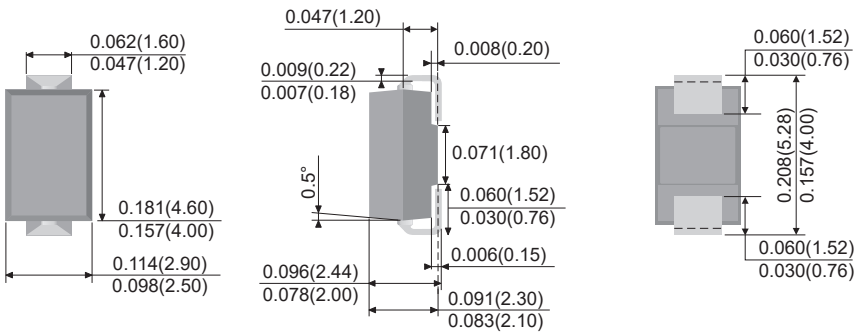

SMA(W)

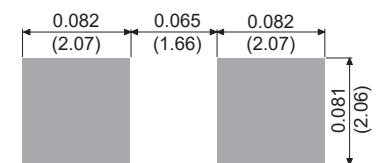

SMBF

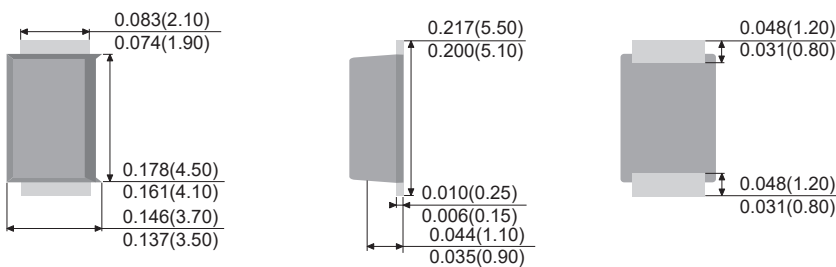

SMBF

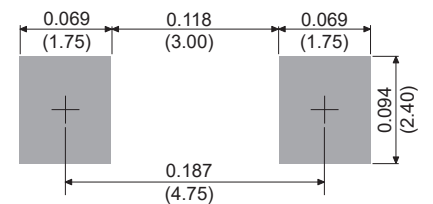

Unit: inch (mm)

Outline Drawing and Minimum Pad Layout

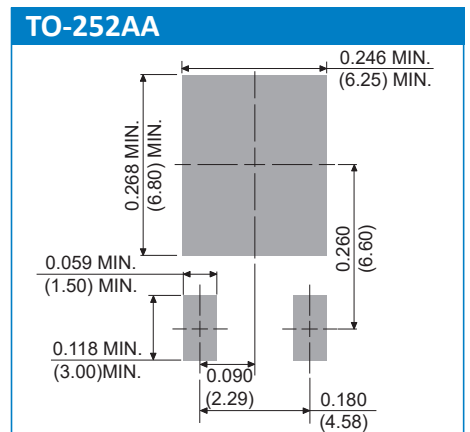
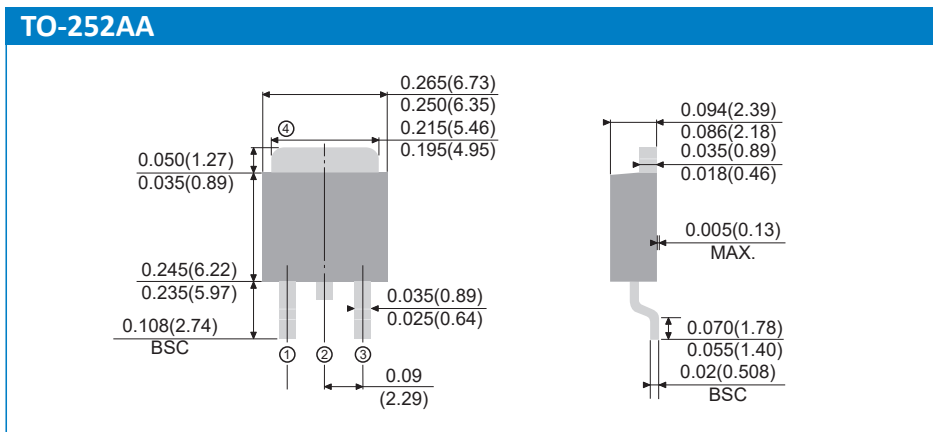
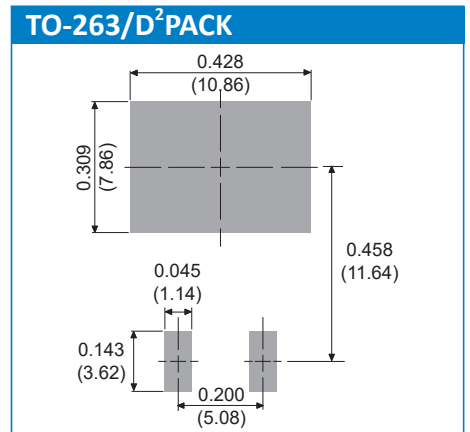
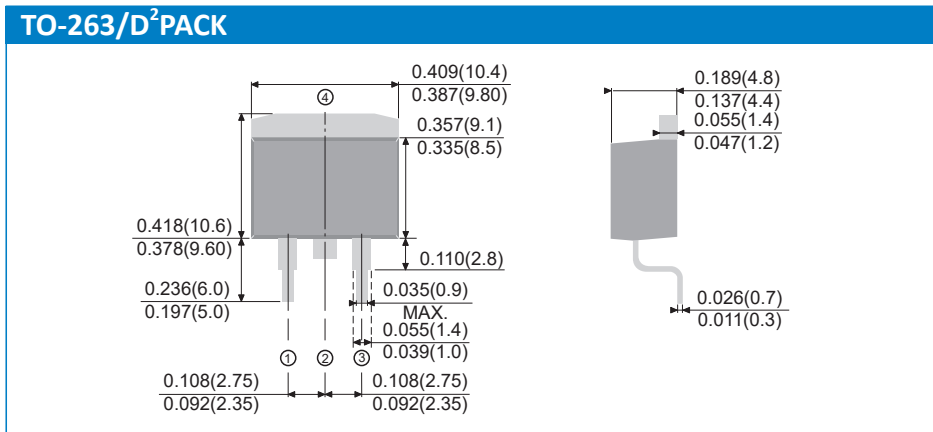
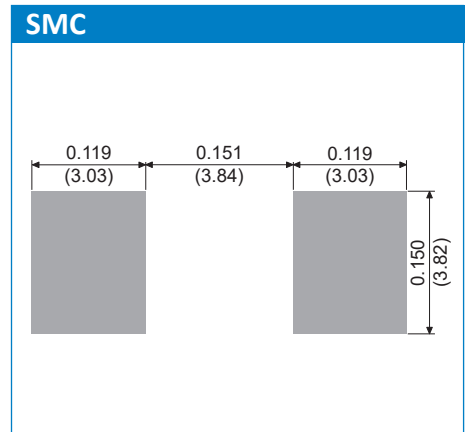
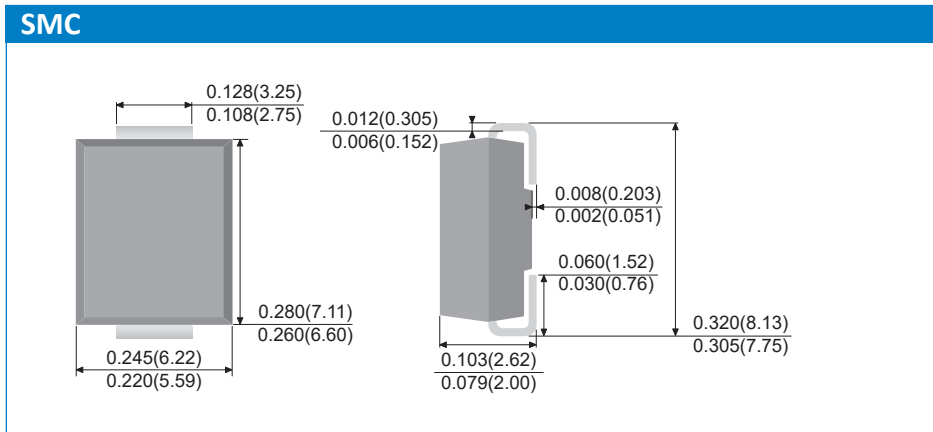
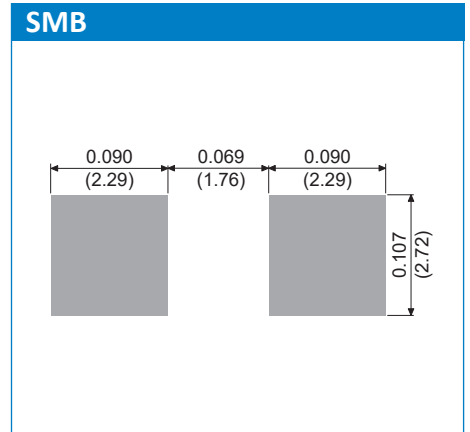
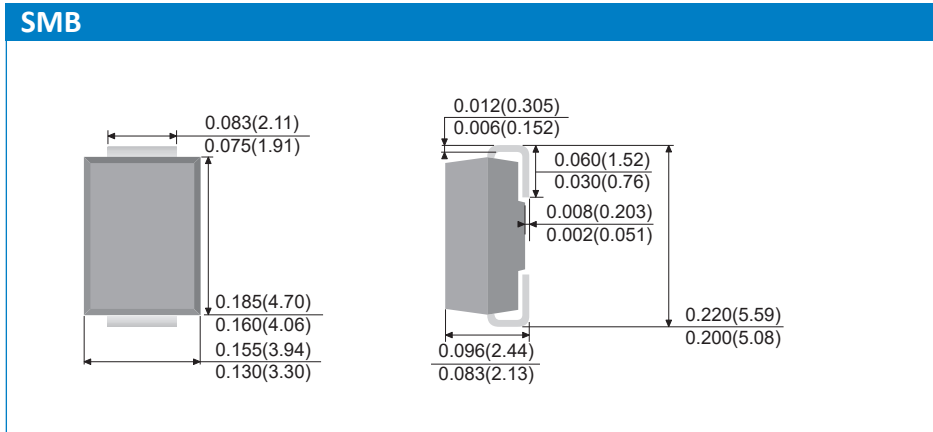

Unit: inch (mm)

Outline Drawing and Minimum Pad Layout

TO-277

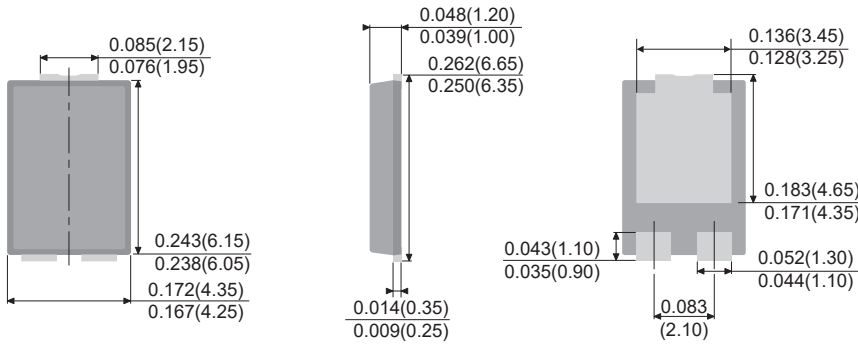

TO-277

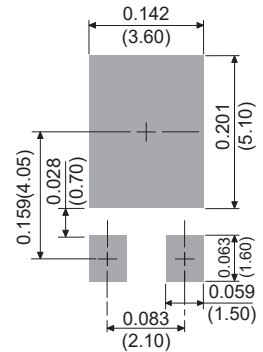

TO-277A

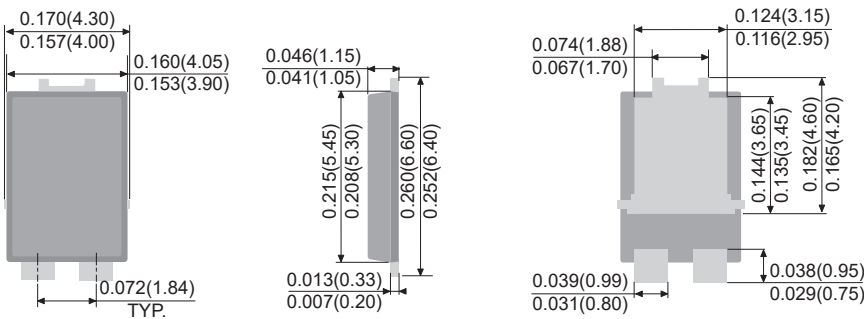

TO-277A

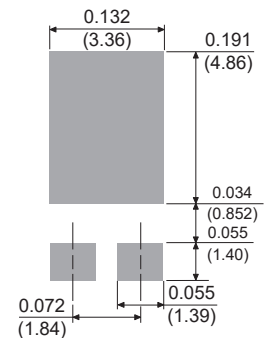

TO-277B

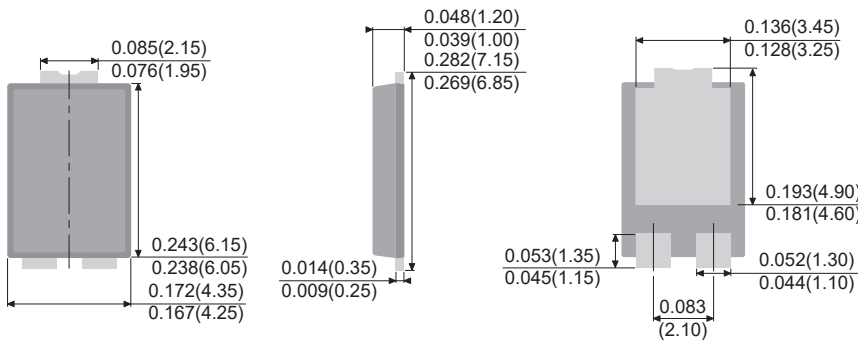

TO-277B

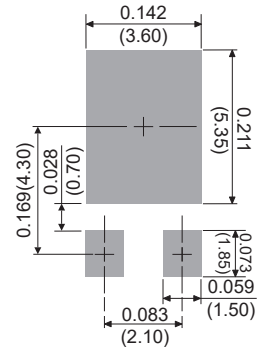

TO-277C

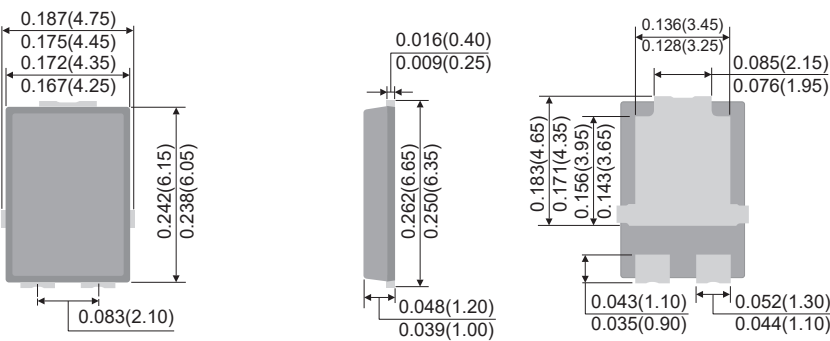

TO-277C

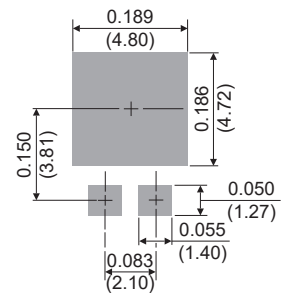

Unit: inch (mm)

Outline Drawing and Minimum Pad Layout

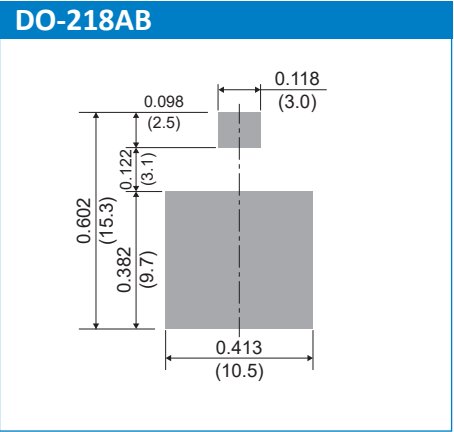
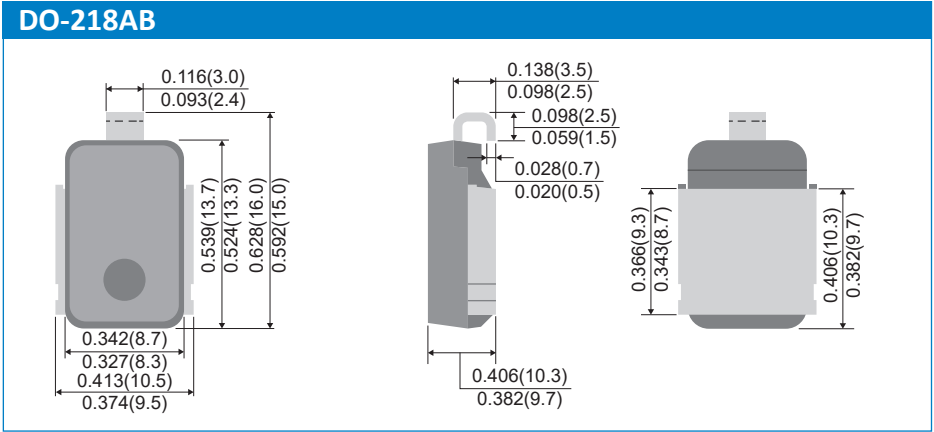

Unit: inch (mm)

Outline Drawing and Minimum Pad Layout

ITO-220AC

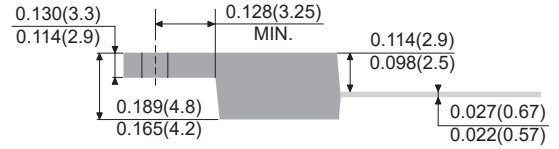
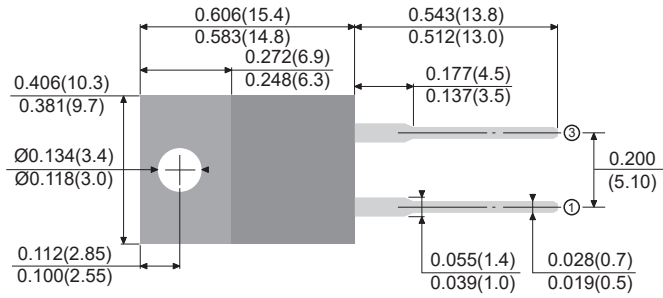

ITO-220AB

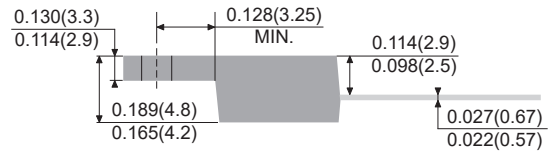
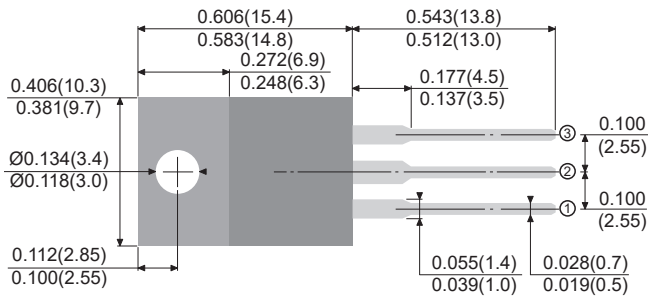

ITO-220AB-F

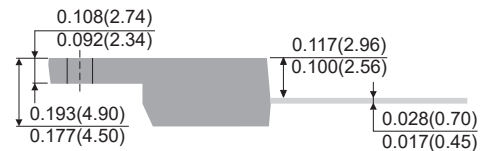
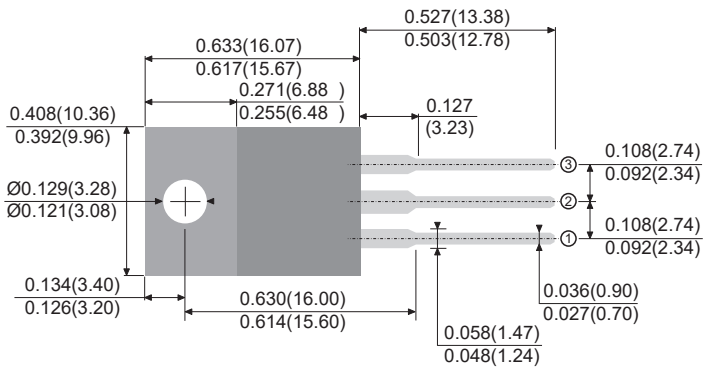

TO-220AC

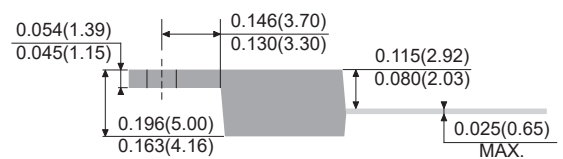
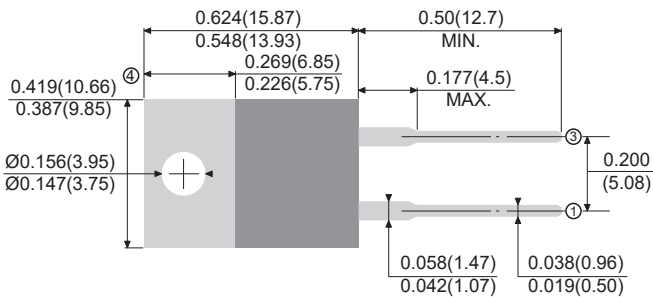

Unit: inch (mm)

Outline Drawing and Minimum Pad Layout

TO-220AB

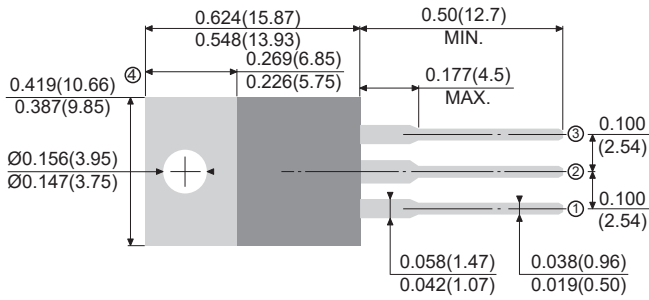

TO-220AB-L

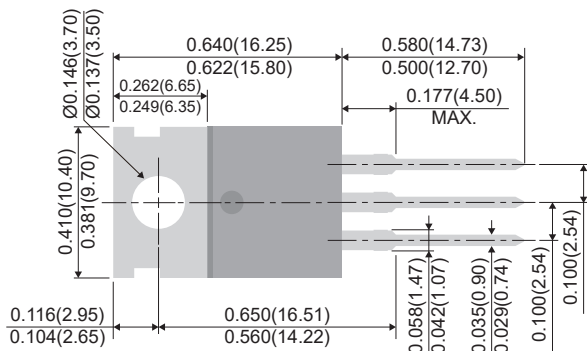

TO-3P/TO-247AD

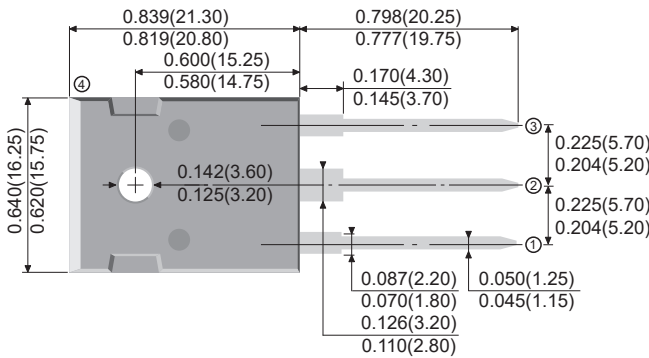

TO-247AD-2LD

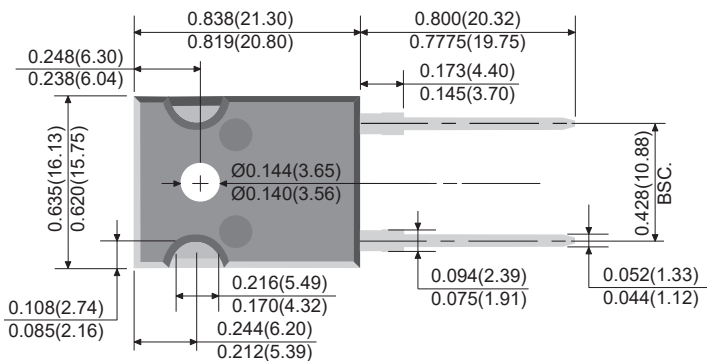

Unit: inch (mm)

Outline Drawing and Minimum Pad Layout

TO-247AD-3LD

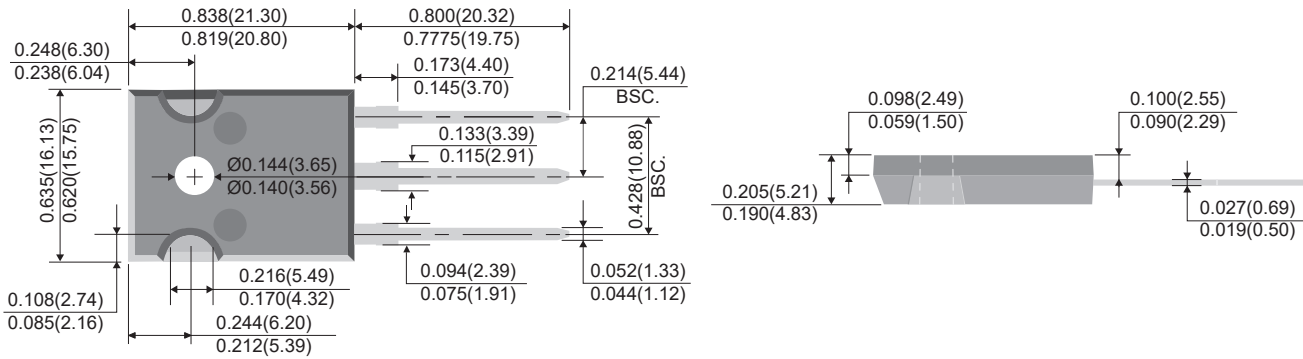

TO-247-3L

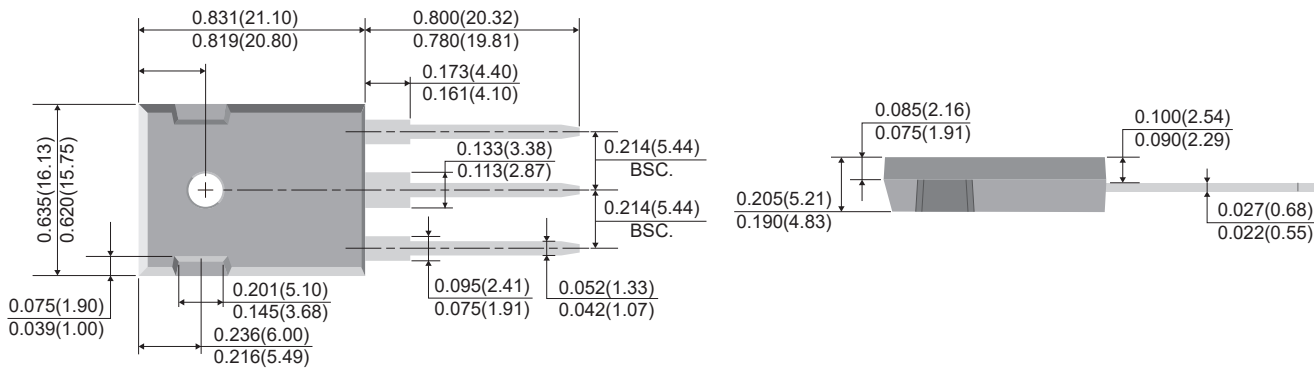

MDI

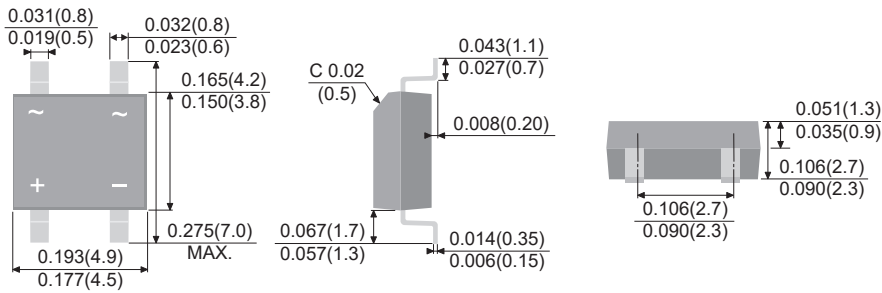

MDI

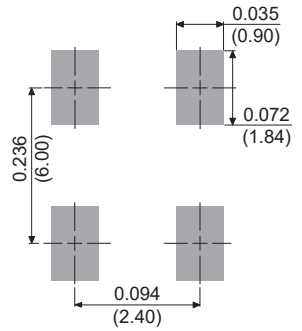

ABS

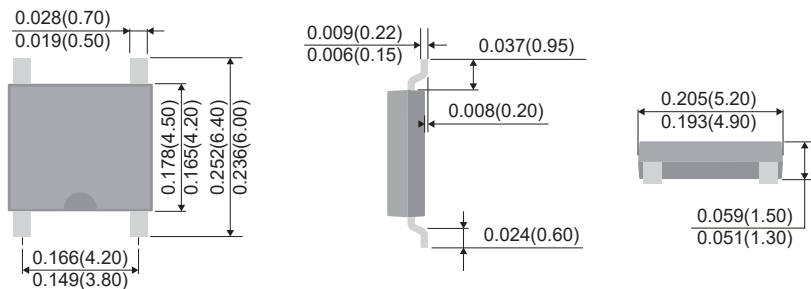

ABS

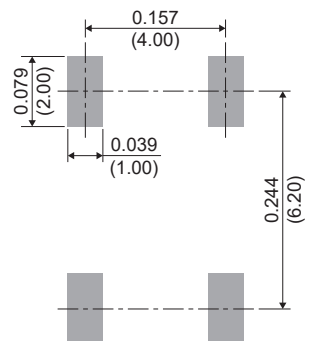

Unit: inch (mm)

Outline Drawing and Minimum Pad Layout

MICRO DIP/TDI

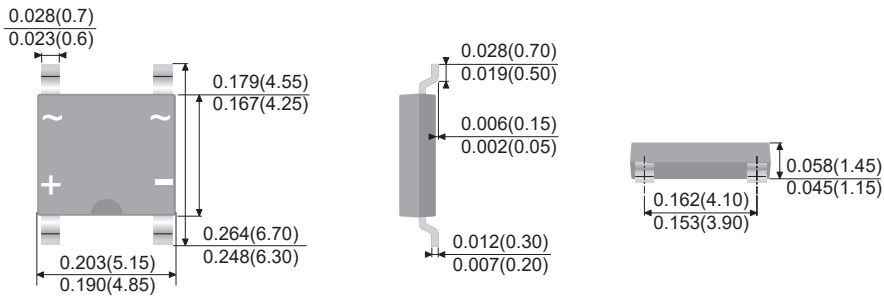

MICRO DIP/TDI

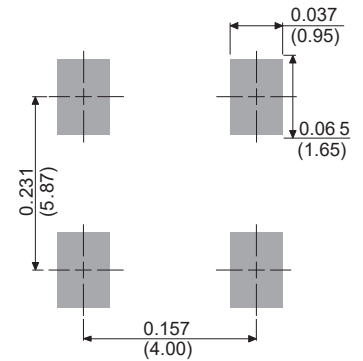

MSBL

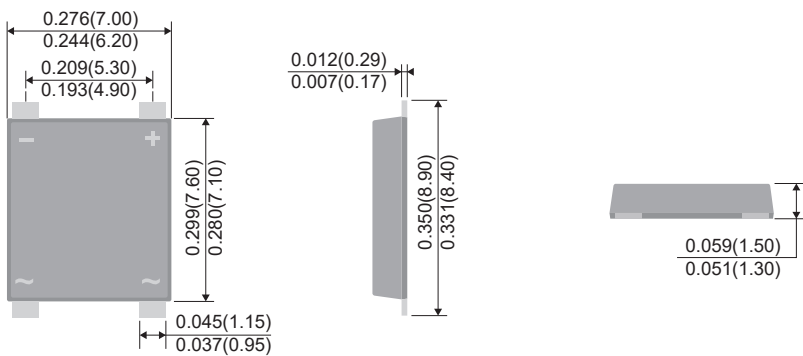

MSBL

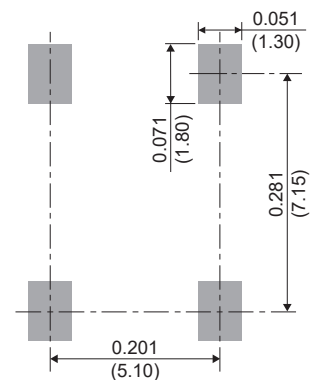

DIP

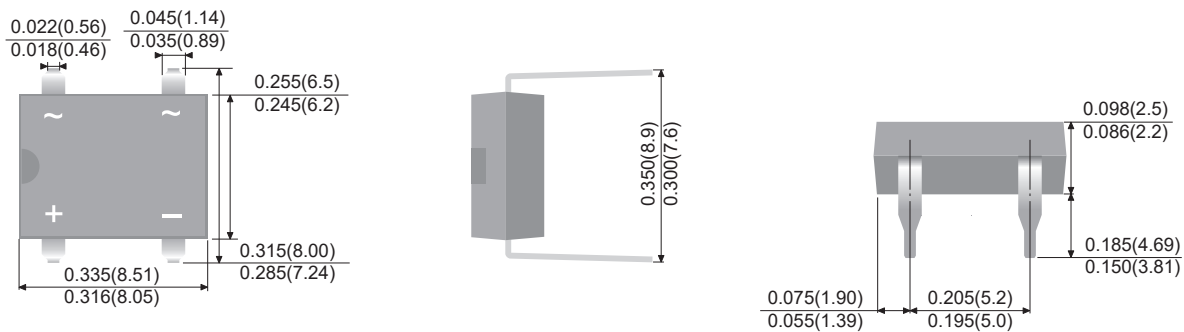

SDIP

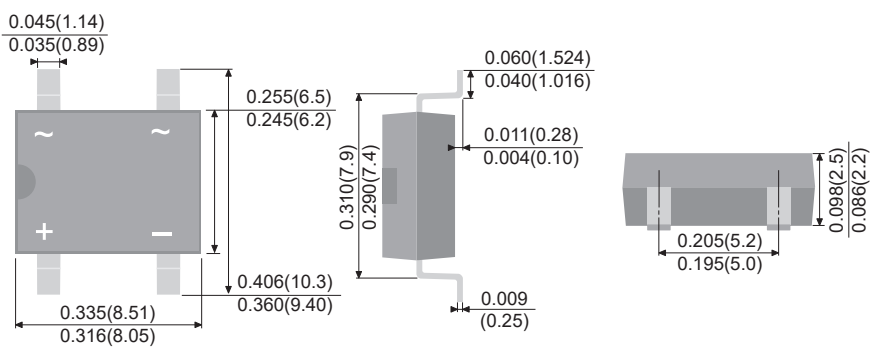

SDIP

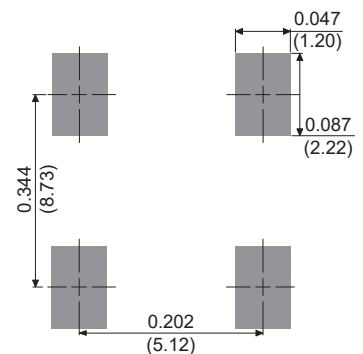

Unit: inch (mm)

Outline Drawing and Minimum Pad Layout

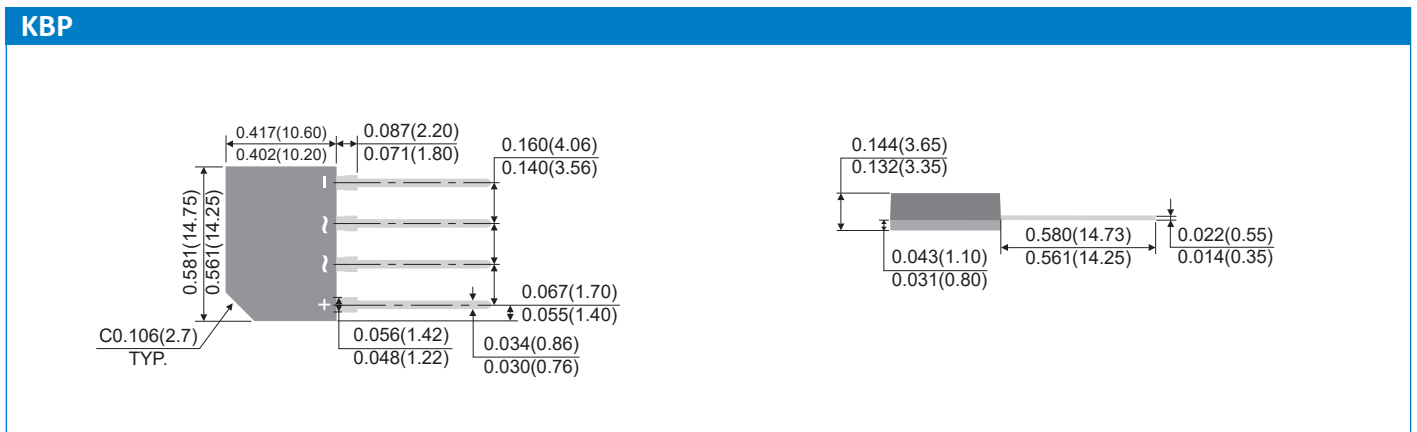
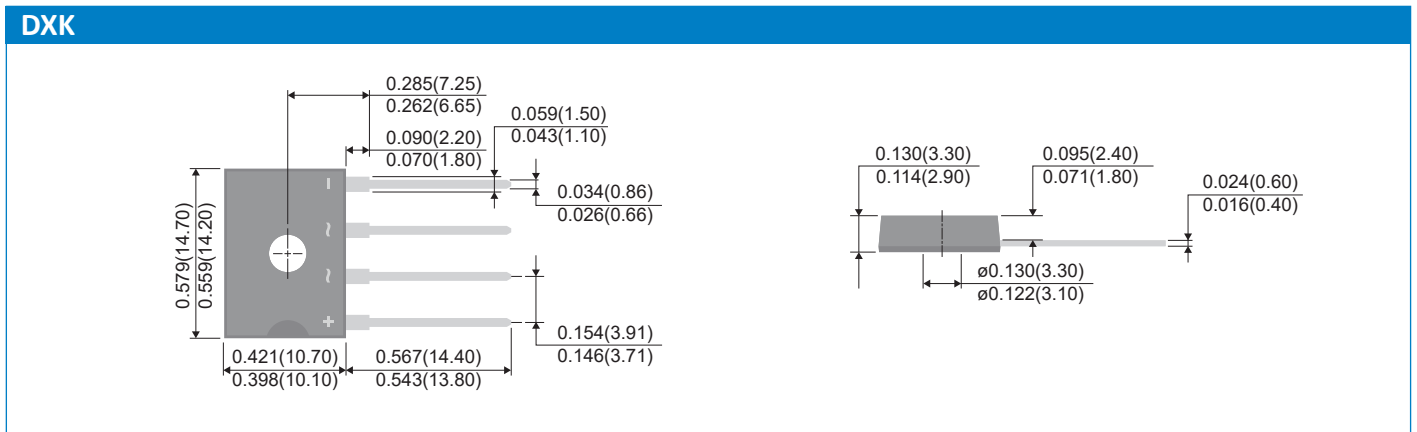
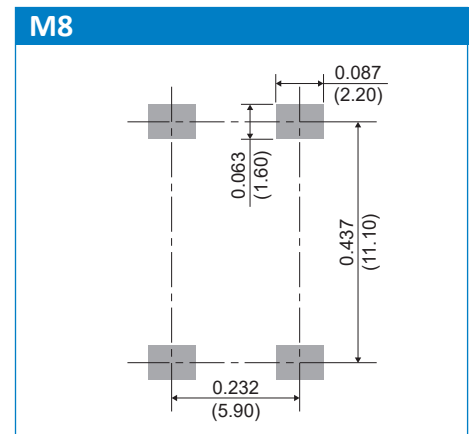
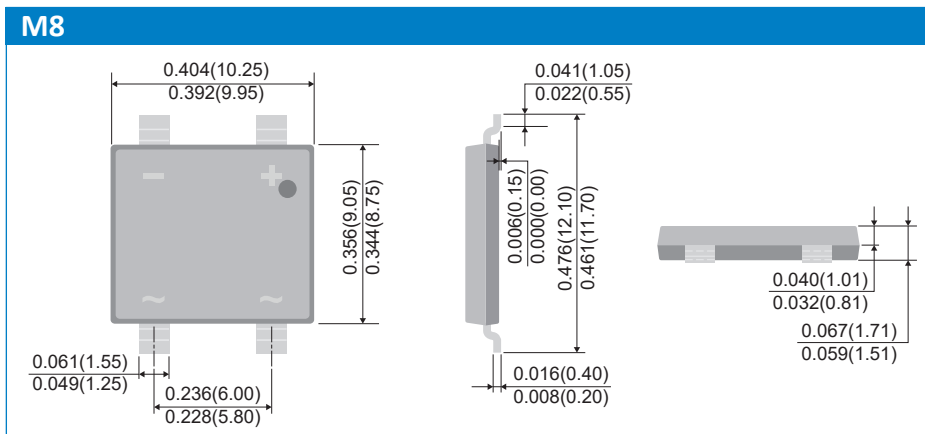
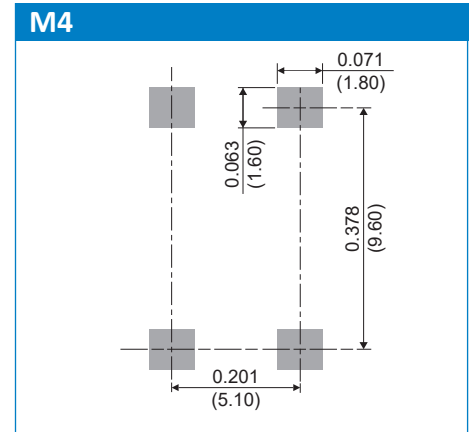
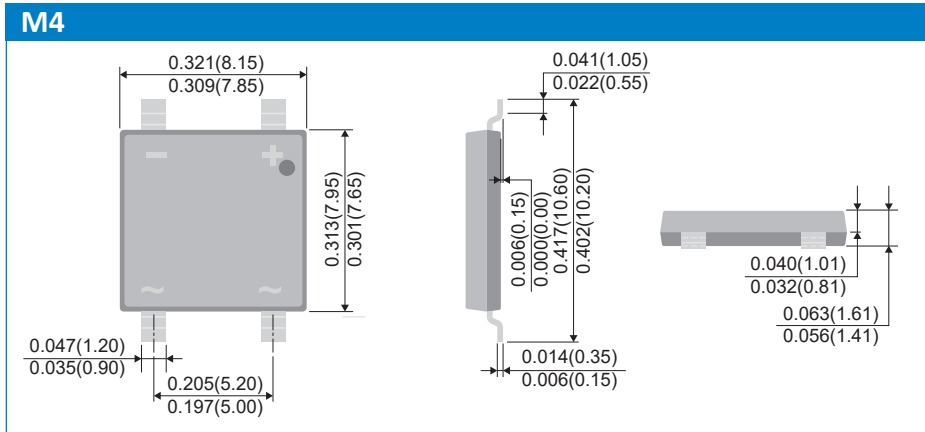

Unit: inch (mm)

Outline Drawing and Minimum Pad Layout

GBL-2

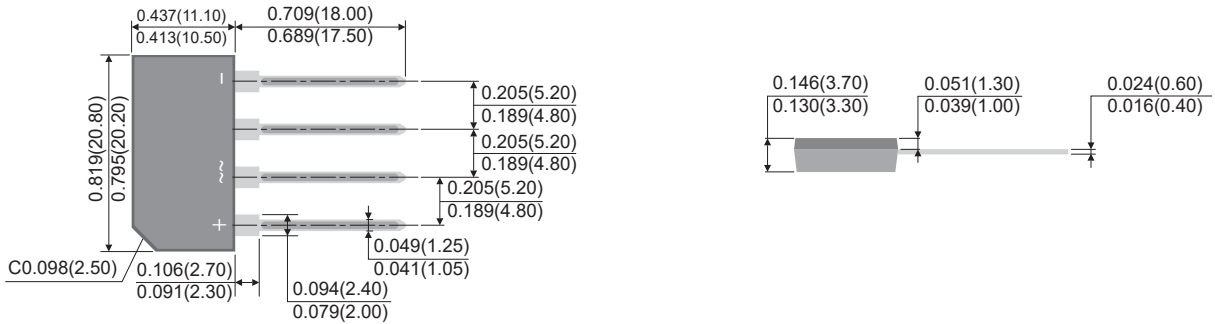

GBU-2

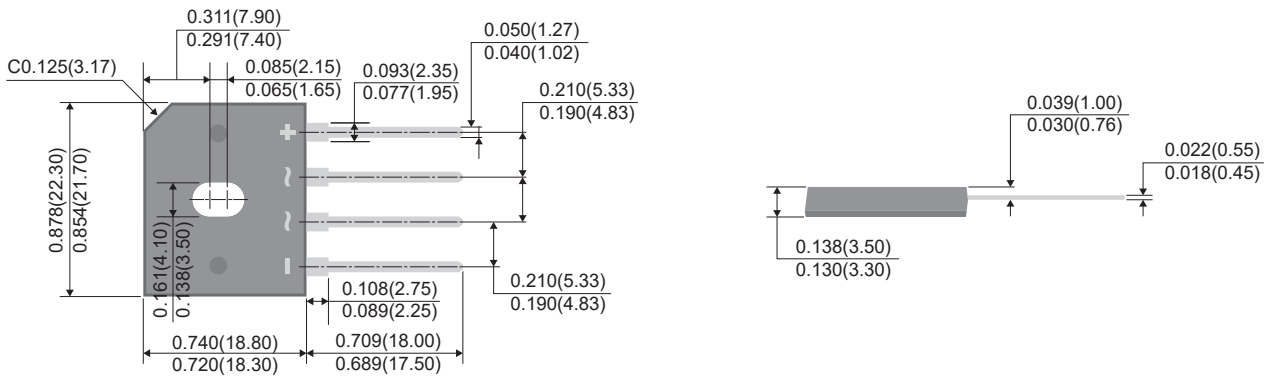

KBJ-2

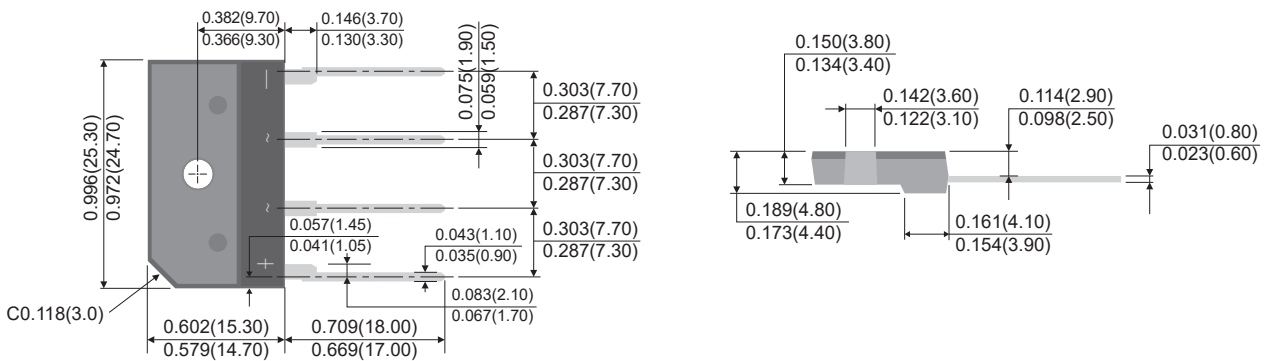

GBJ-2

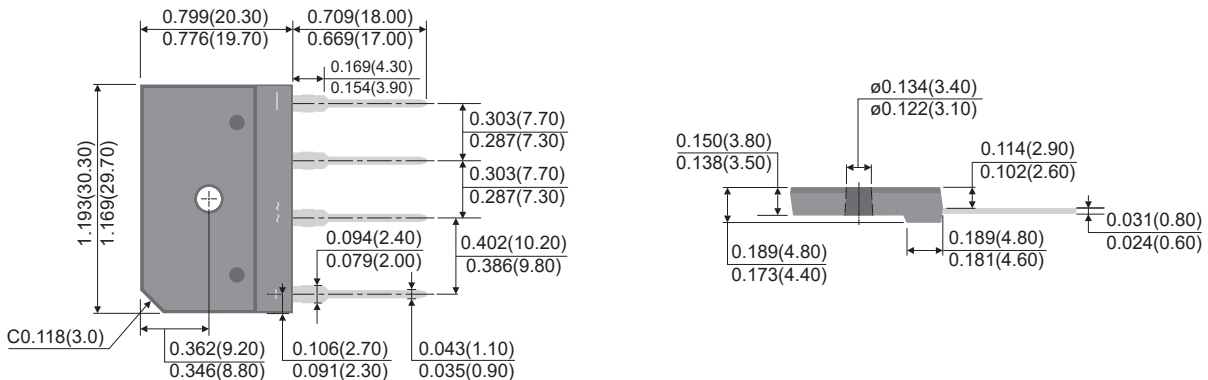

Unit: inch (mm)

Outline Drawing and Minimum Pad Layout

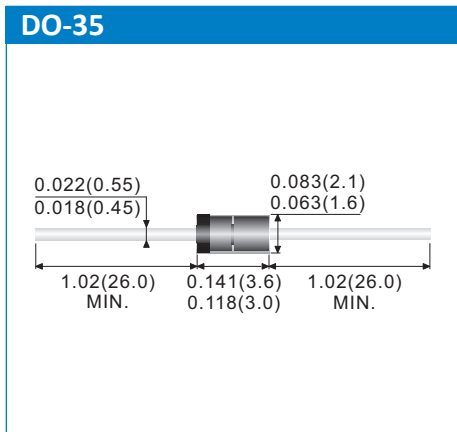
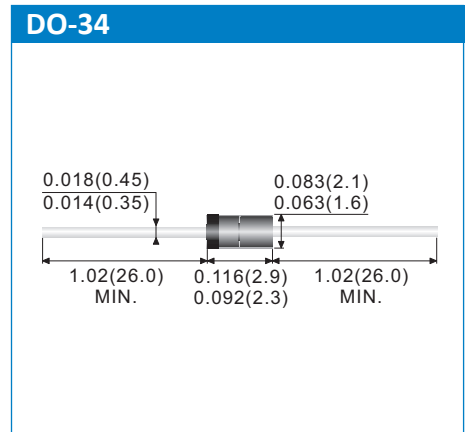
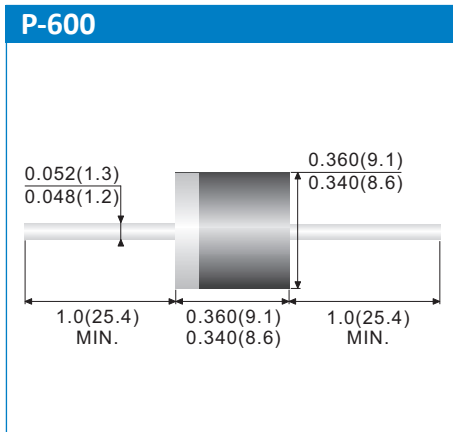
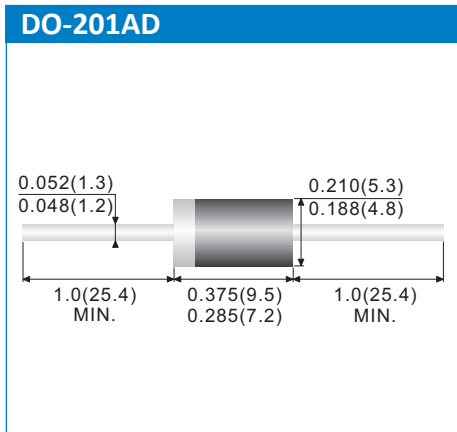
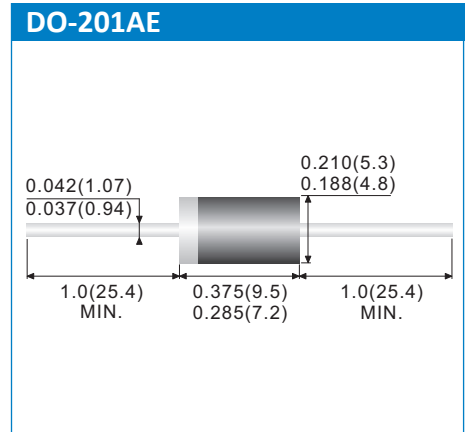
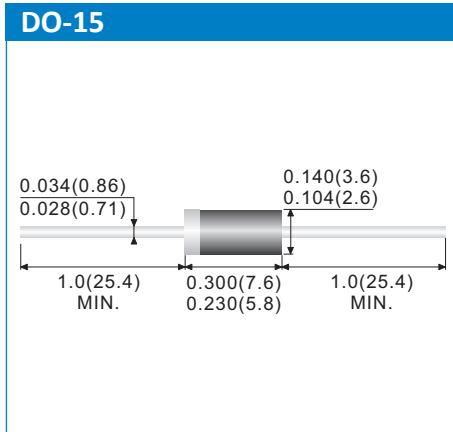
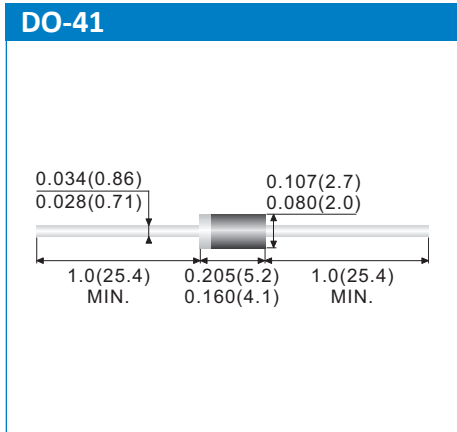

Outline Drawing and Minimum Pad Layout

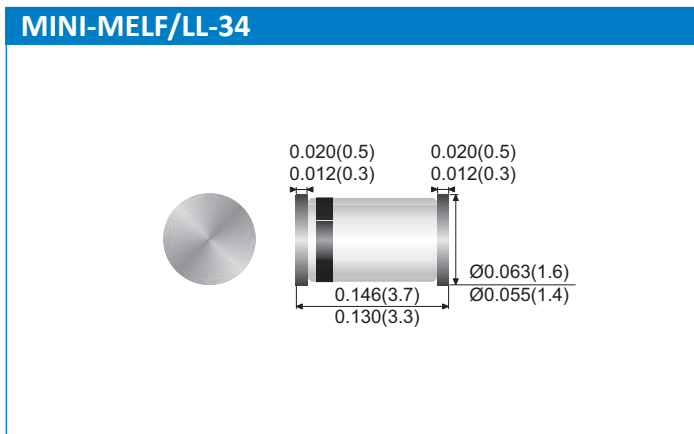
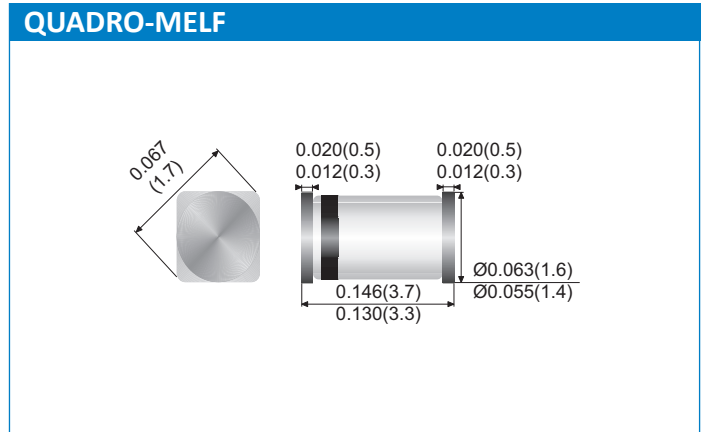
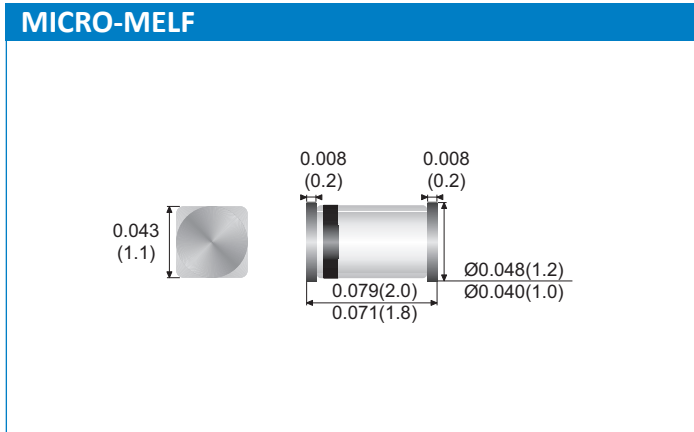

Unit: inch (mm)

All data are subject to change. Please check our data sheets at www.panjit.com for updates.

Tape and Reel Unit Orientation Guidelines

Package	Reel Size		Tape Width	Pitch Dimension(Po)		Pitch Dimension(P1)		Reel Q'ty	Figure No
	inch	mm	mm	inch(±0.004)	mm(±0.1)	inch(±0.004)	mm(±0.1)	PCS	
DFN0603-2L	7	178	8	0.157	4	0.079	2	10,000	5
DFN1006-2L	7	178	8	0.157	4	0.079	2	10,000	5
DFN1006-3L	7	178	8	0.157	4	0.079	2	10,000	6
DFN1010-6L	7	178	8	0.157	4	0.079	2	5,000	3
DFN1610-2L	7	178	8	0.157	4	0.157	4	3,000	4
DFN2020-6L	7	178	8	0.157	4	0.157	4	3,000	2
DFN2020-8L	7	178	8	0.157	4	0.157	4	3,000	2
DFN2020B-6L	7	178	8	0.157	4	0.157	4	3,000	2
DFN3030B-8L	7	178	8	0.157	4	0.157	4	3,000	2
DFN3810-9L	7	178	8	0.157	4	0.157	4	3,000	2
DFN2510-10L	7	178	8	0.157	4	0.157	4	5,000	7
	13	330	8	0.157	4	0.157	4	12,000	7
DFN3333-8L	13	330	12	0.157	4	0.315	8	5,000	1
DFN3333B-8L	13	330	12	0.157	4	0.315	8	5,000	1
DFN5060-8L	13	330	12	0.157	4	0.315	8	3,000	1
DFN5060B-8L	13	330	12	0.157	4	0.315	8	3,000	1
DFN5060X-8L	13	330	12	0.157	4	0.315	8	3,000	1
SOD-923	7	178	8	0.157	4	0.079	2	8,000	23
SOD-123	7	178	8	0.157	4	0.157	4	3,000	22
SOD-123FL	7	178	8	0.157	4	0.157	4	3,000	22
SOD-123HE	7	178	8	0.157	4	0.157	4	3,000	22
	13	330	8	0.157	4	0.157	4	10,000	22
SOD-323	7	178	8	0.157	4	0.157	4	5,000	22
SOD-323HE	7	178	8	0.157	4	0.157	4	5,000	22
	13	330	8	0.157	4	0.157	4	12,000	22
SOD-523	7	178	8	0.157	4	0.157	4	5,000	22
	13	330	8	0.157	4	0.157	4	12,000	22
SOT-723	7	178	8	0.157	4	0.079	2	8,000	21
SOT-523	7	178	8	0.157	4	0.157	4	4,000	19
SOT-23	7	178	8	0.157	4	0.157	4	3,000	16
	13	330	8	0.157	4	0.157	4	12,000	16
SOT-323	7	178	8	0.157	4	0.157	4	3,000	16
	13	330	8	0.157	4	0.157	4	12,000	16
SOT-563	7	178	8	0.157	4	0.157	4	4,000	20
	13	330	8	0.157	4	0.157	4	10,000	20
SOT-353	7	178	8	0.157	4	0.157	4	3,000	17
	13	330	8	0.157	4	0.157	4	10,000	17
SOT-363	7	178	8	0.157	4	0.157	4	3,000	18
	13	330	8	0.157	4	0.157	4	10,000	18
SOT-23 6L	7	178	8	0.157	4	0.157	4	3,000	15
	13	330	8	0.157	4	0.157	4	10,000	15
SOT-23 6L-1	7	178	8	0.157	4	0.157	4	3,000	15
SOT-89	7	178	8	0.157	4	0.157	4	1,000	14

Tape and Reel Unit Orientation Guidelines

Package	Reel Size		Tape Width	Pitch Dimension(Po)		Pitch Dimension(P1)		Reel Q'ty	Figure No
	inch	mm	mm	inch(± 0.004)	mm(± 0.1)	inch(± 0.004)	mm(± 0.1)	PCS	
SMA	7	178	12	0.157	4	0.315	8	1,800	11
	13	330	12	0.157	4	0.315	8	7,500	11
SMA(W)	7	178	12	0.157	4	0.315	8	1,800	11
	13	330	12	0.157	4	0.315	8	7,500	11
SMAF-C	7	178	12	0.157	4	0.157	4	3,000	11
SMB	7	178	12	0.157	4	0.315	8	800	10
	13	330	12	0.157	4	0.315	8	3,000	10
SMBF	13	330	12	0.157	4	0.315	8	5,000	10
SMAG	7	178	12	0.157	4	0.315	8	800	10
SMC	7	178	16	0.157	4	0.157	4	800	9
	13	330	16	0.157	4	0.157	4	3,000	9
SOP-8	13	330	12	0.157	4	0.315	8	2,500	13
SOT-223	13	330	12	0.157	4	0.315	8	2,500	12
TO-277	13	330	12	0.157	4	0.315	8	5,000	30
TO-277B	13	330	16	0.157	4	0.315	8	5,000	31
TO-277C	13	330	12	0.157	4	0.315	8	5,000	30
DO-218AB	13	330	24	0.157	4	0.63	16	600	8
MICRO-MELF	7	178	8	0.157	4	0.157	4	3,000	32
	13	330	8	0.157	4	0.157	4	10,000	32
MINI-MELF /LL34	7	178	8	0.157	4	0.157	4	2,500	32
	13	330	8	0.157	4	0.157	4	10,000	32
ABS	13	330	12	0.157	4	0.63	16	4,000	27
MSBL	13	330	16	0.157	4	0.472	12	3,000	26
SDIP	13	330	16	0.157	4	0.472	12	1,500	26
M4	13	330	16	0.157	4	0.472	12	3,000	25
M8	13	330	24	0.157	4	0.63	16	2,000	24
MDI	13	330	12	0.157	4	0.315	8	3,000	27
MICRO DIP / TDI	7	178	12	0.157	4	0.315	8	1,000	27
	13	330	12	0.157	4	0.315	8	4,000	27
TO-252AA	13	330	16	0.157	4	0.315	8	3,000	29
TO-263(D2PAK)	13	330	24	0.157	4	0.63	16	800	28
TOLL	13	330	24	0.157	4	0.472	12	2,000	33

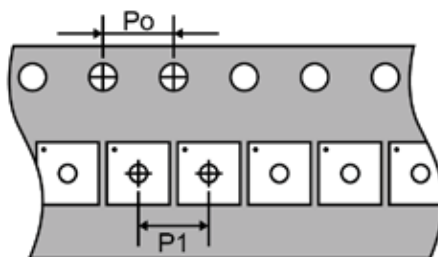

Note 1: Tape and reel dimensions and orientation

Note 2: Packaging methods referred to in this guideline are based on the R1/R2 orientations and apply to packages such as SOT-353, SOT-23 6L, SOT-23 6L-1, SOT-363, and SOT-563. Additionally, S1/S2 packaging options are available, featuring reversed polarities compared to the R1/R2 configurations.

Package Orientation

Direction of Feed

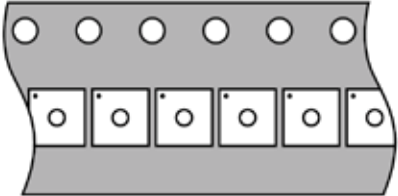
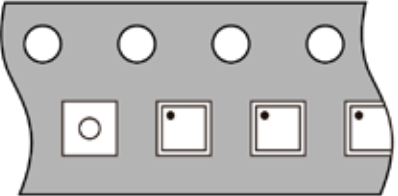
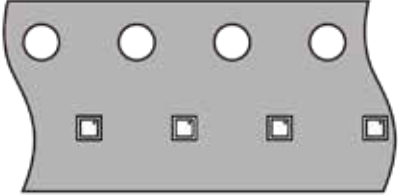
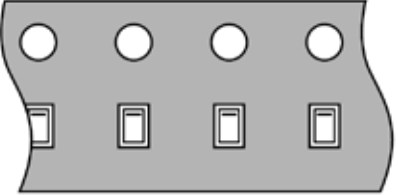
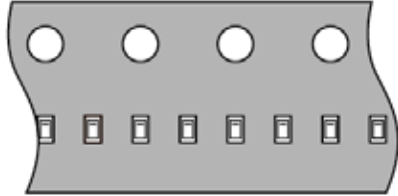
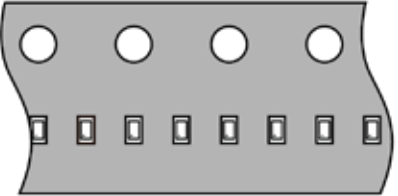
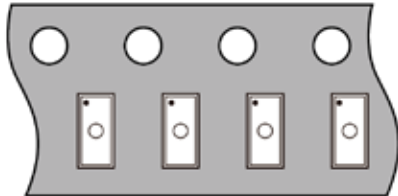
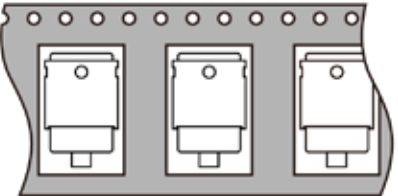
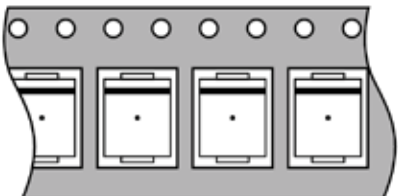
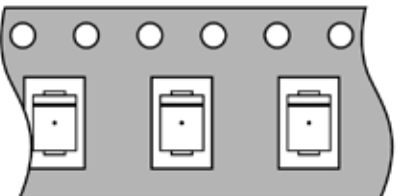

<p>Figure 1. DFN3333-8L/ DFN-3333B-8L/ DFN5060-8L/ DFN5060B-8L/ DFN5060X-8L 12 mm (Tape Width, Typical)</p> 	<p>Figure 2. DFN2020-6L/ DFN2020B-6L/ DFN2020-8L/ DFN3030B-8L/ DFN3810-9L 8 mm (Tape Width, Typical)</p> 
<p>Figure 3. DFN1010-6L 8 mm (Tape Width, Typical)</p> 	<p>Figure 4. DFN1610-2L 8 mm (Tape Width, Typical)</p> 
<p>Figure 5. DFN0603-2L/ DFN1006-2L 8 mm (Tape Width, Typical)</p> 	<p>Figure 6. DFN1006-3L 8 mm (Tape Width, Typical)</p> 
<p>Figure 7. DFN2510-10L 8 mm (Tape Width, Typical)</p> 	<p>Figure 8. DO-218AB 24 mm (Tape Width, Typical)</p> 
<p>Figure 9. SMC 16 mm (Tape Width, Typical)</p> 	<p>Figure 10. SMB/ SMBF/ SMAG 12 mm (Tape Width, Typical)</p> 

Package Orientation

Direction of Feed

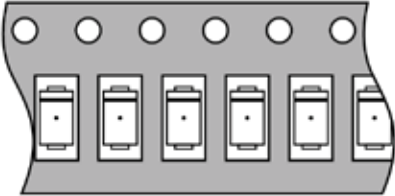
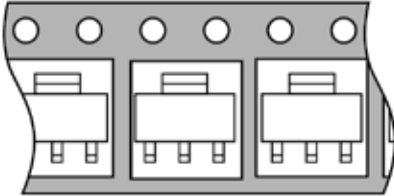
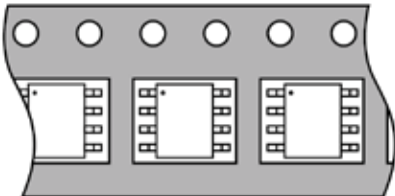
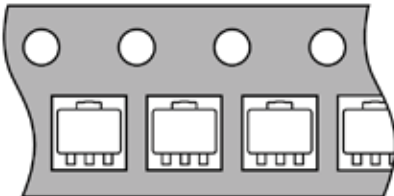
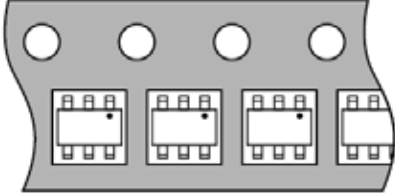
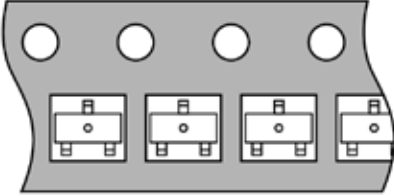
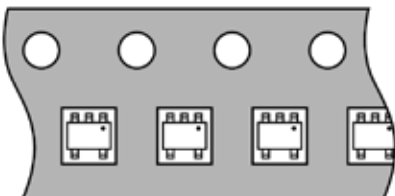
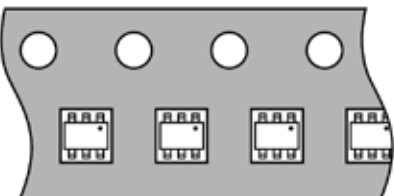
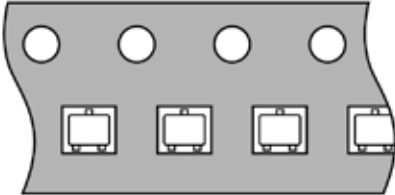
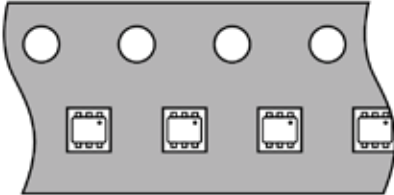

<p>Figure 11. SMA/ SMA(W)/ SMAF-C 12 mm (Tape Width, Typical)</p> 	<p>Figure 12. SOT-223 12 mm (Tape Width, Typical)</p> 
<p>Figure 13. SOP-8 12 mm (Tape Width, Typical)</p> 	<p>Figure 14. SOT-89 8 mm (Tape Width, Typical)</p> 
<p>Figure 15. SOT-23 6L/ SOT-23 6L-1 8 mm (Tape Width, Typical) / (Note.2)</p> 	<p>Figure 16. SOT-23/ SOT-323 8 mm (Tape Width, Typical)</p> 
<p>Figure 17. SOT-353 8 mm (Tape Width, Typical) / (Note.2)</p> 	<p>Figure 18. SOT-363 8 mm (Tape Width, Typical) / (Note.2)</p> 
<p>Figure 19. SOT-523 8 mm (Tape Width, Typical)</p> 	<p>Figure 20. SOT-563 8 mm (Tape Width, Typical) / (Note.2)</p> 

Package Orientation

Direction of Feed

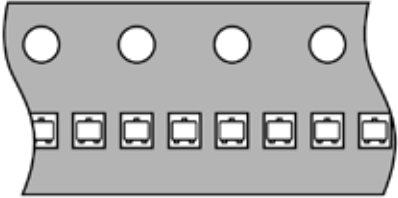
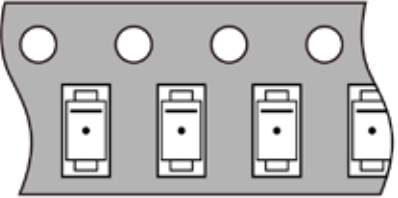
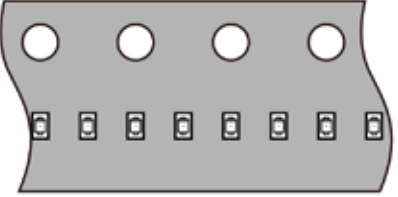
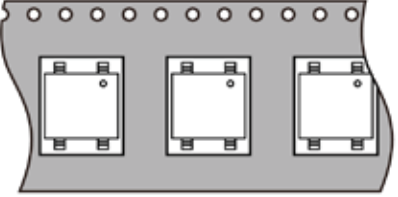
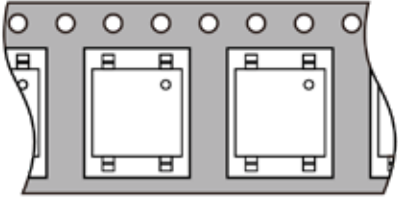
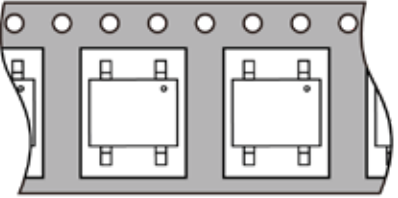
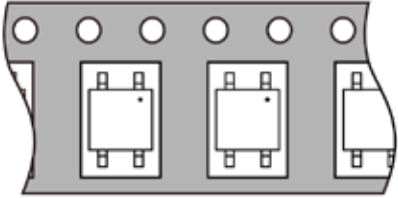
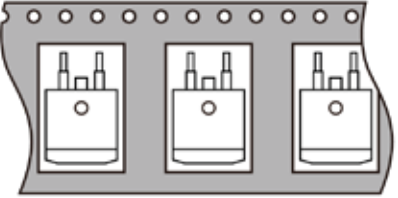
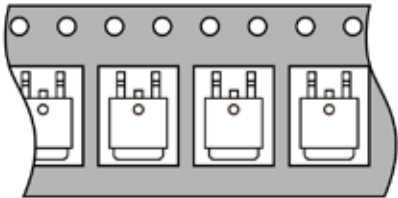
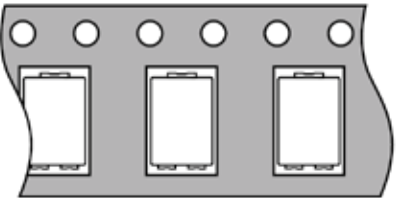

<p>Figure 21. SOT-723 8 mm (Tape Width, Typical)</p> 	<p>Figure 22. SOD-123/ SOD-123FL/ SOD-123HE/ SOD-323/ SOD-323HE/ SOD-523 8 mm (Tape Width, Typical)</p> 
<p>Figure 23. SOD-923 8 mm (Tape Width, Typical)</p> 	<p>Figure 24. M8 24 mm (Tape Width, Typical)</p> 
<p>Figure 25. M4 16 mm (Tape Width, Typical)</p> 	<p>Figure 26. SDIP/ MSBL 16 mm (Tape Width, Typical)</p> 
<p>Figure 27. MDI/ MICRO DIP/ ABS 12 mm (Tape Width, Typical)</p> 	<p>Figure 28. TO-263 24 mm (Tape Width, Typical)</p> 
<p>Figure 29. TO-252AA 16 mm (Tape Width, Typical)</p> 	<p>Figure 30. TO-277/ TO-277C 12 mm (Tape Width, Typical)</p> 

Package Orientation

Direction of Feed

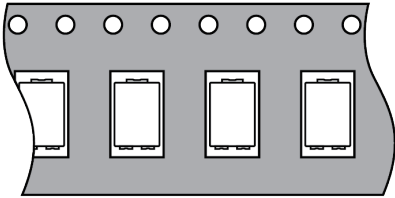
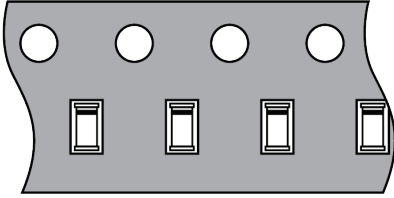
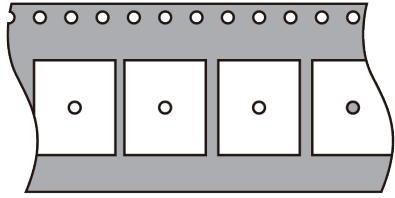

<p>Figure 31. TO-277B 16 mm (Tape Width, Typical)</p> 	<p>Figure 32. MICRO-MELF/ MINI-MELF (LL34) 8 mm (Tape Width, Typical)</p> 
<p>Figure 33. TOLL 24 mm (Tape Width, Typical)</p> 	

Reflow Profile

Base on current research, we propose using SnAg3Cu0.5 eutectic solder for lead free products and using Sn63 Pb37 eutectic solder for Sn-Pb products. Our temperature profile for product testing is based on experiment and JEDEC J-STD-020E specification.

Profile Feature	Sn-Pb Eutectic Assembly	Pb-Free Assembly
Preheat/Soak		
Temperature Min (T_{smin})	100 °C	150 °C
Temperature Max (T_{smax})	150 °C	200 °C
Time (t_s) from (T_{smin} to T_{smax})	60-120 seconds	60-120 seconds
Ramp-up rate (T_L to T_p)	3 °C/second max.	3 °C/second max.
Liquidous temperature (T_L)	183 °C	217 °C
Time (t_L) maintained above T_L	60-150 seconds	60-150 seconds
Peak package body temperature (T_p)	For users T_p must not exceed the Classification temp in Table 4-1. For suppliers T_p must equal or exceed the Classification temp in Table 4-1.	For users T_p must not exceed the Classification temp in Table 4-2. For suppliers T_p must equal or exceed the Classification temp in Table 4-2.
Time (t_p)* within 5 °C of the specified classification temperature (T_c), see Figure 5-1.	20* seconds	30* seconds
Ramp-down rate (T_p to T_L)	6 °C/second max.	6 °C/second max.
Time 25 °C to peak temperature	6 minutes max.	8 minutes max.

* Tolerance for peak profile temperature (T_p) is defined as a supplier minimum and a user maximum.

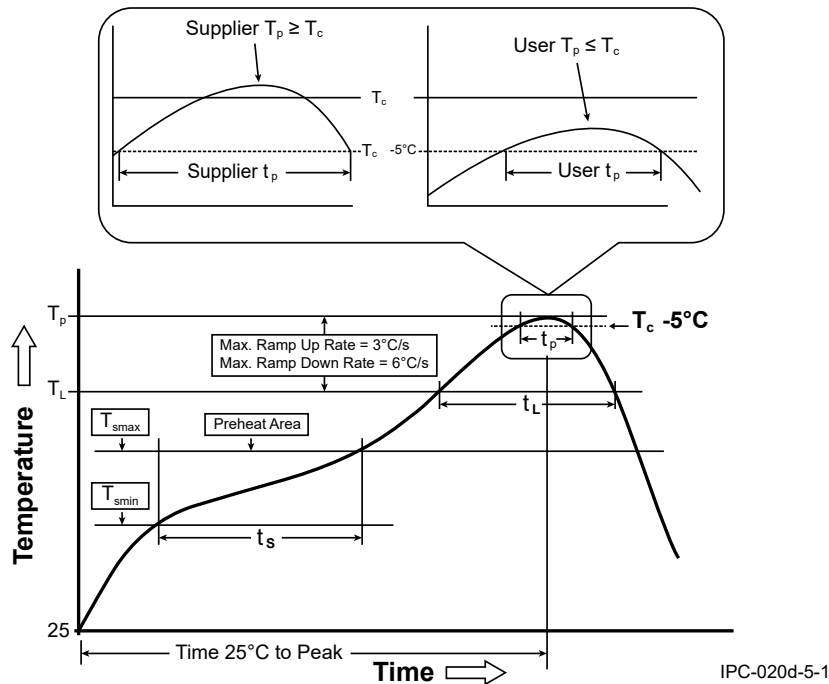

Table 4-1 SnPb Eutectic Process - Classification Temperatures (T_c)

Package Thickness	Volume mm ³ <350	Volume mm ³ ≥350
<2.5 mm	235 °C	220 °C
≥2.5 mm	220 °C	220 °C

Table 4-2 Pb-Free Process - Classification Temperatures (T_c)

Package Thickness	Volume mm ³ <350	Volume mm ³ 350 - 2000	Volume mm ³ >2000
<1.6 mm	260 °C	260 °C	260 °C
1.6 mm - 2.5 mm	260 °C	250 °C	245 °C
>2.5 mm	250 °C	245 °C	245 °C

Lead Free Wave solder Profile

Wave soldering involves using the highest solder temperature and heat transfer rates, which particularly affect small resin-molded components such as transistors, integrated circuits, and surface mount components. This process includes a profile with a short dwell time in the solder pot and preheating to address thermal shock for ceramic components and temperature issues with resin-molded parts. Below is a typical temperature profile utilizing a 96.5/3.0/0.5 solder alloy.

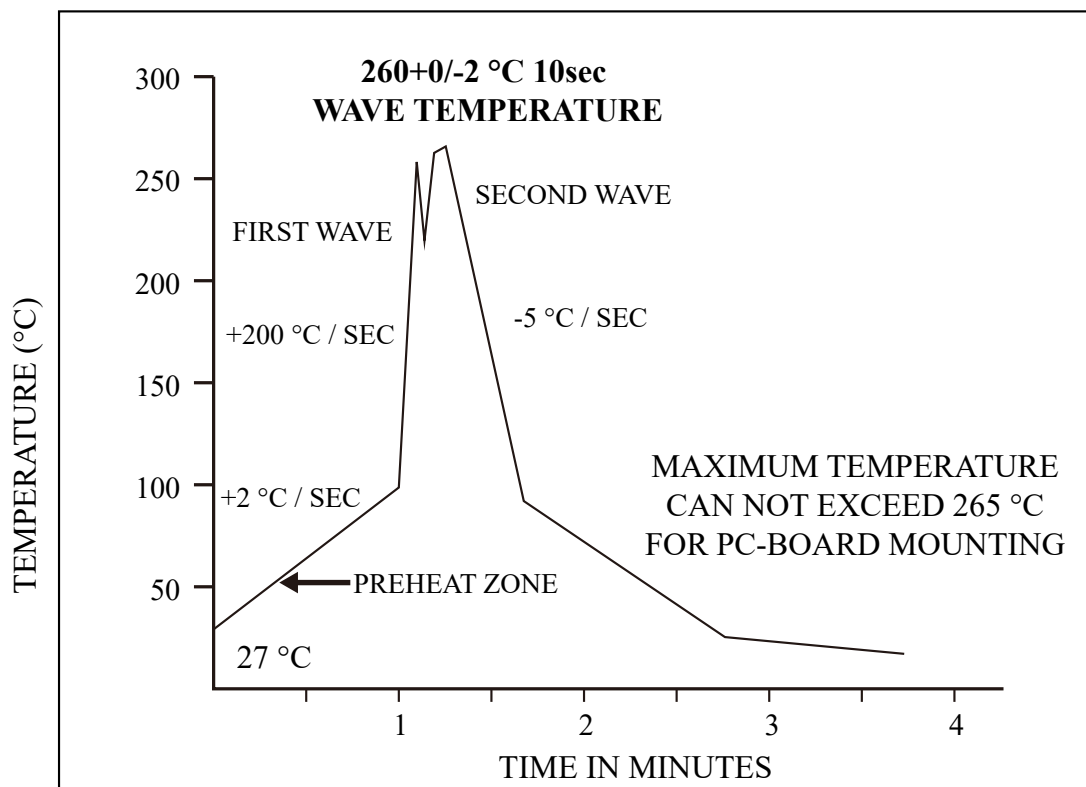

Packing Specifications - Reel Packing

Package	Reel Size	Reel	Carton Size	Carton	Approx. Gross Weight
	(inch)	(pcs)	(mm)	(EA)	(kg)
Reel Packing					
DFN0603-2L	7	10,000	390 x 270 x 400	800,000	9.00
DFN1006-2L	7	10,000	390 x 270 x 400	800,000	5.00
DFN1006-3L	7	10,000	390 x 270 x 400	800,000	5.00
DFN1610-2L	7	3,000	390 x 270 x 400	240,000	9.70
DFN1010B-6L	7	5,000	455 x 270 x 440	400,000	8.84
DFN2020-6L	7	3,000	455 x 270 x 440	240,000	12.30
DFN2020B-6L	7	3,000	455 x 270 x 440	240,000	12.30
DFN2020-8L	7	3,000	455 x 270 x 440	240,000	11.20
DFN2510-10L	7	5,000	390 x 270 x 400	400,000	10.50
	13	12,000	375 x 360 x 213	144,000	6.40
DFN2510A-10L	7	3,000	455 x 270 x 440	240,000	10.95
DFN3333-8L	13	5,000	375 x 360 x 422	80,000	10.50
DFN3333B-8L	13	5,000	375 x 360 x 422	80,000	10.50
DFN3810-9L	7	3,000	390 x 240 x 420	120,000	4.40
DFN5060-8L	13	3,000	375 x 360 x 422	48,000	14.19
DFN5060B-8L	13	3,000	375 x 360 x 422	48,000	14.19
DFN5060X-8L	13	3,000	375 x 360 x 422	48,000	14.19
TOLL	13	2,000	375 x 360 x 447	16,000	12.50
TSSOP-18	13	2,500	375 x 360 x 422	20,000	8.94
SOD-923	7	8,000	390 x 270 x 400	640,000	7.70
SOD-523	7	5,000	390 x 270 x 400	400,000	9.10
	13	12,000	375 x 360 x 230	144,000	5.40
SOD-323HE	7	5,000	390 x 270 x 400	400,000	11.90
	13	12,000	375 x 360 x 230	144,000	8.30
SOD-323	7	5,000	390 x 270 x 400	400,000	9.40
	13	12,000	375 x 360 x 230	144,000	5.90
SOD-323S	7	3,000	410 x 290 x 410	240,000	8.75
SOD-123HE	7	3,000	390 x 270 x 400	240,000	12.40
	13	10,000	375 x 360 x 230	120,000	8.10
SOD-123FL	7	3,000	390 x 270 x 400	240,000	10.60
	13	10,000	375 x 360 x 230	120,000	7.20
SOD-123	7	3,000	390 x 270 x 400	240,000	9.90
	13	10,000	375 x 360 x 230	120,000	6.50
SOT-723	7	8,000	455 x 270 x 440	640,000	10.50
SOT-563	7	4,000	390 x 270 x 400	320,000	10.00
	13	10,000	375 x 360 x 230	120,000	5.20
SOT-523	7	4,000	390 x 270 x 400	320,000	10.00
SOT-363	7	3,000	390 x 270 x 400	240,000	9.30
	13	10,000	375 x 360 x 230	120,000	7.10
SOT-323	7	3,000	390 x 270 x 400	240,000	7.90
	13	12,000	375 x 360 x 230	144,000	6.10

Packing Specifications - Reel Packing

Package	Reel Size	Reel	Carton Size	Carton	Approx. Gross Weight
	(inch)	(pcs)	(mm)	(EA)	(kg)
Reel Packing					
SOT-23 6L	7	3,000	390 x 270 x 400	240,000	14.50
	13	10,000	375 x 360 x 230	120,000	7.90
SOT-23 6L-1	7	3,000	390 x 270 x 400	240,000	14.90
	13	10,000	375 x 360 x 230	120,000	8.10
SOT-23	7	3,000	390 x 270 x 400	240,000	9.80
	13	12,000	375 x 360 x 230	144,000	7.00
SOT-223	13	2,500	375 x 360 x 422	40,000	14.96
SOT-89	7	1,000	455 x 270 x 440	80,000	15.64
SMAF-C	7	3,000	390 x 240 x 420	120,000	10.90
	13	10,000	375 x 360 x 422	160,000	14.10
SMBF	7	1,500	390 x 240 x 420	60,000	9.60
	13	5,000	375 x 360 x 422	80,000	15.60
SMA(W)	7	1,800	390 x 240 x 420	100,800	13.00
	13	7,500	355 x 355 x 400	150,000	20.45
SMA/DO-214AC	7	1,800	390 x 220 x 370	72,000	9.98
	13	7,500	375 x 360 x 390	120,000	17.35
SMB/DO-214AA	7	800	390 x 220 x 370	32,000	7.69
	13	3,000	375 x 360 x 390	48,000	13.23
SMC/DO-214AB	7	800	390 x 220 x 370	24,000	10.79
	13	3,000	375 x 360 x 390	42,000	17.98
DO-218AB	13	600	375 x 360 x 230	2,400	10.25
DO-41	13	5,000	340 x 340 x 410	25,000	11.04
DO-15	13	4,000	340 x 340 x 410	20,000	11.39
DO-201AD	13	1,250	340 x 340 x 410	6,250	9.20
DO-201AE	13	1,250	340 x 340 x 410	6,250	9.20
P-600	13	800	340 x 340 x 410	4,000	9.85
DO-34	15	10,000	365 x 370 x 410	50,000	10.10
DO-35	15	10,000	365 x 370 x 410	50,000	11.20
MICRO-MELF	7	3,000	390 x 270 x 400	240,000	8.80
	13	10,000	355 x 355 x 400	200,000	11.50
QUADRO-MELF	7	2,500	390 x 270 x 400	200,000	13.30
	13	10,000	355 x 355 x 400	200,000	14.90
MINI-MELF/LL-34	7	2,500	390 x 270 x 400	200,000	12.70
	13	10,000	355 x 355 x 400	200,000	14.60
MDI	13	3,000	375 x 360 x 390	48,000	14.71
ABS	13	4,000	375 x 360 x 422	64,000	17.80
MICRO DIP/TDI	7	1,000	390 x 240 x 420	40,000	9.50
	13	4,000	375 x 360 x 422	64,000	17.00
MSBL	13	3,000	375 x 360 x 422	48,000	21.50
SDIP	13	1,500	375 x 360 x 390	21,000	14.31
M4	13	3,000	375 x 360 x 390	42,000	14.00
M8	13	2,000	375 x 360 x 390	16,000	16.86
TO-277	7	1,500	390 x 240 x 420	60,000	12.20
	13	5,000	375 x 360 x 422	80,000	19.10
TO-277A	13	5,000	375 x 360 x 422	80,000	18.52
TO-277B	13	5,000	375 x 360 x 422	80,000	20.60
TO-277C	7	1,500	390 x 240 x 420	60,000	13.50
	13	5,000	375 x 360 x 422	80,000	20.80
TO-252AA	13	3,000	375 x 360 x 422	48,000	24.16
TO-263/D ² PAK	13	800	375 x 360 x 422	6,400	14.70

Packing Specifications - Bulk Packing

Package	Inner Box Size	Box	Carton Size	Carton	Approx. Gross Weight
	(mm)	(EA)	(mm)	(EA)	(kg)
Bulk Packing					
DO-41	198 x 84 x 20	1,000	459 x 214 x 256	50,000	19.30
DO-15	200 x 85 x 25	1,000	459 x 214 x 256	40,000	20.70
DO-201AD	200 x 85 x 40	500	459 x 214 x 256	12,500	15.95
DO-201AE	200 x 85 x 40	500	459 x 214 x 256	12,500	15.95
P-600	208 x 82 x 40	100	459 x 214 x 256	2,500	6.83
DO-34	240 x 90 x 100	2,000	410 x 268 x 345	120,000	14.50
DO-35	240 x 90 x 100	2,000	410 x 268 x 345	120,000	17.10
TO-220AB	540 x 145 x 85	2,000	555 x 306 x 200	8,000	22.00
TO-220AC	540 x 145 x 85	2,000	555 x 306 x 200	8,000	21.76
ITO-220AC	540 x 145 x 85	2,000	555 x 306 x 200	8,000	19.34
TO-220AB-L	540 x 145 x 85	2,000	555 x 306 x 200	8,000	24.63
ITO-220AB	540 x 145 x 85	2,000	555 x 306 x 200	8,000	19.58
ITO-220AB-F	540 x 145 x 85	2,000	555 x 306 x 200	8,000	25.50
TO-263/D ² PAK	540 x 145 x 85	2,000	555 x 306 x 200	8,000	18.70
TO-3P/TO-247AD	-	-	530 x 243 x 100	1,500	13.90
TO-247AD-2LD	-	-	530 x 243 x 100	1,500	14.35
TO-247AD-3LD	-	-	530 x 243 x 100	1,500	12.90
DIP	-	-	459 x 214 x 256	12,000	6.45
SDIP	-	-	459 x 214 x 256	24,000	15.72
DXK	550 x 200 x 122	2,800	565 x 215 x 265	5,600	13.80
KBP	545 x 200 x 122	2,800	560 x 215 x 269	5,600	13.95
GBL-2	550 x 200 x 122	2,000	565 x 215 x 265	4,000	13.15
GBU-2	485 x 185 x 120	1,000	500 x 200 x 270	2,000	12.54
KBJ-2	550 x 200 x 122	1,000	565 x 215 x 265	2,000	13.13
GBJ-1	490 x 201 x 104	750	505 x 225 x 235	1,500	16.00
GBJ-2	485 x 185 x 120	900	500 x 200 x 270	1,800	18.20

Packing Specifications - Ammunition Packing

Package	Inner Box Size	Ammo	Carton Size	Carton	Approx. Gross Weight
	(mm)	(pcs)	(mm)	(EA)	(kg)
Ammunition Packing					
DO-41	255 x 75 x 150	5,000	339 x 276 x 330	40,000	15.9
	255 x 73 x 95	3,000	333 x 281 x 218	24,000	8.9
DO-15	255 x 75 x 150	3,000	339 x 276 x 330	24,000	13.25
	255 x 73 x 95	1,500	339 x 276 x 330	18,000	8.64
DO-201AD	255 x 75 x 150	1,250	339 x 276 x 330	10,000	13.36
	255 x 75 x 95	750	339 x 276 x 330	9,000	11.62
DO-201AE	255 x 75 x 95	1,250	339 x 276 x 330	10,000	13.36
	255 x 75 x 95	750	339 x 276 x 330	9,000	11.62
P-600	255 x 75 x 150	400	339 x 276 x 330	3,200	8.1
DO-34	248 x 80 x 48	5,000	410 x 268 x 345	150,000	15.3
	248 x 80 x 75	5,000	410 x 268 x 345	100,000	13.1
DO-35	248 x 80 x 48	5,000	410 x 268 x 345	150,000	17.5
	248 x 80 x 75	5,000	410 x 268 x 345	100,000	15.7

Sales Office

KAOHSIUNG, TAIWAN

PANJIT International Inc.
No.24, Gangshan N. Rd., Gangshan Dist.,
Kaohsiung City 82063, Taiwan
Tel.+886-7-621-3121 Fax.+886-7-621-3129
82063 高雄市岡山區岡山路24號

TAIPEI, TAIWAN

PANJIT International Inc.
34F, No. 95, Sec. 1, Xintai 5th Rd., Xizhi Dist., New Taipei City 22175, Taiwan
Tel.+886-2-2627-1898 Fax.+886-2-2627-8856
22175 新北市汐止區新台五路一段95號34樓

WUXI, CHINA

PANJIT ELECTRONICS (WUXI) CO., Ltd.
No.8, Hanjang Rd., Wuxi New Dist., Wuxi,
Jiangsu 214028, China
Tel.+86-510-8522-8922
214028 江蘇省無錫市無錫新區漢江路8號

SUZHOU, CHINA

SUZHOU GRANDE ELECTRONICS CO., Ltd.
International Center of Jiangsu Province Room 905(&903),
No.88, Shishan Rd., High-tech Dist., Suzhou, Jiangsu 215129, China
Tel.+86-512-6536-7711
215129 江蘇省蘇州市高新區獅山路88號(金河國際中心905室(&903室))

SHENZHEN, CHINA

PANJIT Electronics (wuxi) Co., Ltd., Shenzhen
8/F, Building 1, Jinjijia Science Park, Jinke Rd.,
Pingli Boulevard Nanwan Street, Longgang Dist.,
Shenzhen City, China
Tel.+86-755-8970-9768
518111 深圳市龍崗區南灣街道平李大道金科路金積嘉科技園1棟8樓

HONGKONG, CHINA

PAN-JIT INTERNATIONAL (H.K.) Ltd.
Rm. F & G, 4/F, Golden Bear Industrial Centre,
No. 66-82, Chai Wan Kok Street, Tsuen Wan, N.T. Kowloon, Hong Kong
Tel.+852-2751-8413 Fax.+852-2751-8272
香港新界荃灣柴灣角街66-82號金熊工業中心4樓F-G室

ARIZONA, USA

PANJIT AMERICAS Inc.
2507 West Erie Drive, Suite 101, Tempe Arizona 85282 USA
Tel.+1-602-414-1700 Fax.+1-602-431-2141

MUNICH, GERMANY

PANJIT EUROPE GmbH
Otto-Hahn-Str.2, 85609 Ascheim, Germany
Tel.+49-89-729-4900-12 Fax.+49-89-729-4900-11

YONGIN, KOREA

PANJIT KOREA Co., Ltd.
3601, Tower A, HeungDeok IT Valley, 13 HeungDeok 1-Ro,
GiHeung-Gu, YongIn-Si, GyeongGi-Do, 16954 Korea
Tel.+82-31-202-6270 Fax.+82-31-202-1974

TOKYO, JAPAN

PANJIT Japan Inc.
〒180-0004 No.606 KS BUILDING 6F, 1-31-11 KUCHIJOJI HONCHO,
MUSASHINO-SHI TOKYO, JAPAN
Tel. +81-0-422-27-1843/1844
FAX. +81-0-422-27-1844

Manufacturing Location

KAOHSIUNG, TAIWAN

PANJIT International Inc.
No.24, Gangshan N. Rd., Gangshan Dist.,
Kaohsiung City 82063, Taiwan
Tel.+886-7-621-3121 Fax.+886-7-621-3129
82063 高雄市岡山區岡山路24號

KAOHSIUNG, TAIWAN

PYNMAX TECHNOLOGY CO., Ltd. 《Wafer Foundry》
No.17, Yonggong 1st Rd., Yongan Dist.,
Kaohsiung City 82841, Taiwan
Tel.+886-7-624-3919 Fax.+886-7-621-4719
82841 高雄市永安區永安工業區永工一路17號

WUXI, CHINA

PANJIT ELECTRONICS (WUXI) CO., Ltd.
No.8, Hanjang Rd., Wuxi New Dist., Wuxi,
Jiangsu 214028, China
Tel.+86-510-8522-8922
214028 江蘇省無錫市無錫新區漢江路8號

SHANDONG, CHINA

PANJIT Electronics (Shandong) Co., Ltd. 《Wafer Foundry》
No.186, Zhong Run Rd. Hightech Zone, Zibo,
Shandong 255000, China
Tel.+86-533-3985-299
255000 山東省淄博市高新區中潤大道186號

XUZHOU, CHINA

PANJIT Semiconductor (Xuzhou) Co., Ltd.
No.10 Fenghuang Avenue, Economic Development Zone,
Xuzhou, Jiangsu 221121, China
Tel.+86-516-8335-2888
221121 江蘇省徐州市經濟開發區鳳凰大道10號

CABUYAO, PHILIPPINES

No.1 Hologram St. cor Main Ave., LISP1 SEPZ,
Cabuyao, Laguna, PH 4025



強茂股份有限公司
PANJIT International Inc.



www.panjit.com

Ver. 24.1

PANJIT
SEMI
CONDUCTOR

強茂股份有限公司
PANJIT International Inc.