



# DMMT3904W

## MATCHED NPN SMALL SIGNAL SURFACE MOUNT TRANSISTOR

**VOLTAGE** 40 Volt **POWER** 225 mWatt

**SOT-363**

Unit : inch(mm)

### FEATURES

- NPN epitaxial silicon, planar design
- Collector-emitter voltage  $V_{CE} = 40V$
- Collector current  $I_C = 200mA$
- Lead free in compliance with EU RoHS 2.0
- Green molding compound as per IEC 61249 standard

### MECHANICAL DATA

- Case: SOT-363, Plastic
- Terminals: Solderable per MIL-STD-750, Method 2026
- Approx. Weight: 0.0002 ounces, 0.006 grams
- Marking: S4A

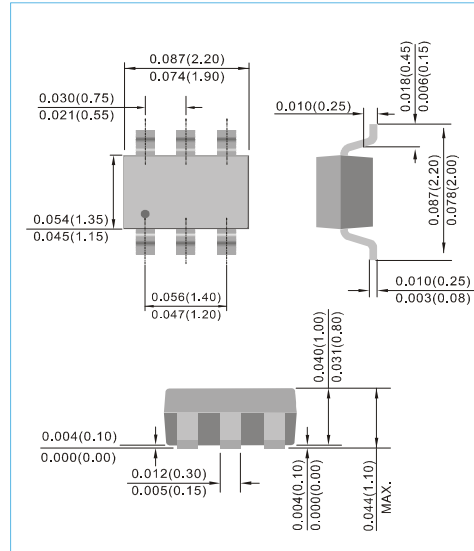

### ABSOLUTE RATINGS

PARAMETER	SYMBOL	VALUE	UNITS
Collector - Base Voltage	$V_{CBO}$	60	V
Collector - Emitter Voltage	$V_{CEO}$	40	V
Emitter - Base Voltage	$V_{EBO}$	6.0	V
Collector Current - Continuous	$I_C$	200	mA
Power Dissipation (Note2)	$P_{TOT}$	225	mW
Thermal Resistance, Junction to Ambient (Note2)	$R_{\theta JA}$	625	$^{\circ}C/W$
Operating and Storage Temperature Range	$T_J, T_{STG}$	-55 to 150	$^{\circ}C$

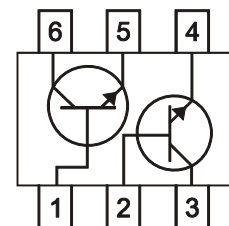

Fig.108(TOP VIEW)

Note:1.Built with adjacent die from a single wafer.

2.Device mounted on FR4 PCB: 70 x 60 x 1mm.



# DMMT3904W

## ELECTRICAL CHARACTERISTICS

PARAMETER	Symbol	Test Condition	MIN.	MAX.	Units
Collector - Base Breakdown Voltage	$V_{(BR)CBO}$	$I_C=10\mu A, I_E=0$	60	-	V
Collector - Emitter Breakdown Voltage	$V_{(BR)CEO}$	$I_C=1.0mA, I_B=0$	40	-	V
Emitter - Base Breakdown Voltage	$V_{(BR)EBO}$	$I_E=10\mu A, I_C=0$	6.0	-	V
Collector Cutoff Current	$I_{CEX}$	$V_{CE}=30V, V_{EB(off)}=3.0V$	-	50	nA
Base Cutoff Current	$I_{BI}$	$V_{CE}=30V, V_{EB(off)}=3.0V$	-	50	nA
DC Current Gain	$h_{FE}$	$I_C=0.1mA, V_{CE}=1.0V$ $I_C=1.0mA, V_{CE}=1.0V$ $I_C=10mA, V_{CE}=1.0V$ $I_C=50mA, V_{CE}=1.0V$ $I_C=100mA, V_{CE}=1.0V$	40 70 100 60 30	- - 300 - -	-
Collector - Emitter Saturation Voltage	$V_{CE(SAT)}$	$I_C=10mA, I_B=1.0mA$ $I_C=50mA, I_B=5.0mA$	-	0.2 0.3	V
Base - Emitter Saturation Voltage	$V_{BE(SAT)}$	$I_C=10mA, I_B=1.0mA$ $I_C=50mA, I_B=5.0mA$	0.65 -	0.85 0.95	V
Base - Emitter Voltage Matching	$\Delta V_{BE}$	$V_{CE}=5V, I_C=2mA$	-	1	mV
Output Capacitance	$C_{OBO}$	$V_{CB}=5V, I_E=0, f=1MHz$	-	4.0	pF
Input Capacitance	$C_{IBO}$	$V_{CB}=0.5V, I_C=0, f=1MHz$	-	8.0	pF
Input Impedance	$h_{ie}$	$V_{CE}=10V, I_C=0mA, f=1.0KHz$	1.0	10	k $\Omega$
Voltage Feedback Ratio	$h_{re}$		0.5	8	$\times 10^{-4}$
Small Signal Current Gain	$h_{fe}$		100	400	-
Output Admittance	$h_{oe}$		1.0	40	$\mu s$
Current Gain-Bandwidth Product	ft		$V_{CE}=20V, I_C=10mA, f=100MHz$	300	-
Noise Figure	NF	$V_{CE}=5.0V,$ $I_C=100\mu A, RS=1.0k\Omega, f=1.0KHz$	-	5.0	dB
Delay Time	td	$V_{CC}=3V, V_{BE}=0.5V,$ $I_C=10mA, I_B=1.0mA$	-	35	ns
Rise Time	tr	$V_{CC}=3V, V_{BE(off)}=0.5V,$ $I_C=10mA, I_B=1.0mA$	-	35	ns
Storage Time	ts	$V_{CC}=3V, I_C=10mA$ $I_{B1}=I_{B2}=1.0mA$	-	200	ns
Fall Time	tf	$V_{CC}=3V, I_C=10mA$ $I_{B1}=I_{B2}=1.0mA$	-	50	ns

Note 2: Pulse Test: Pulse Width < 300 us, Duty Cycle < 2.0%.



# DMMT3904W

## ELECTRICAL CHARACTERISTICS CURVE

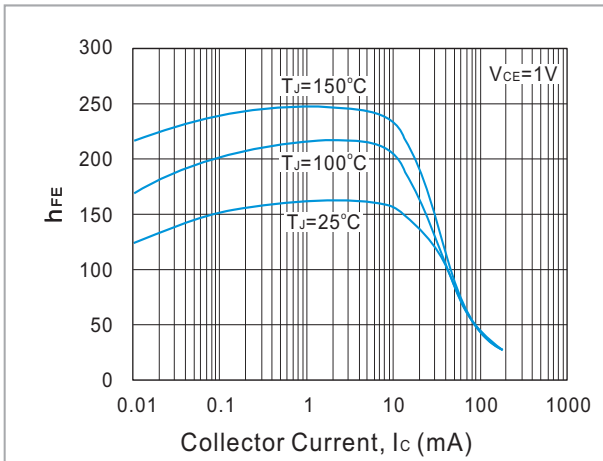

**Fig. 1. Typical  $h_{FE}$  vs. Collector Current**

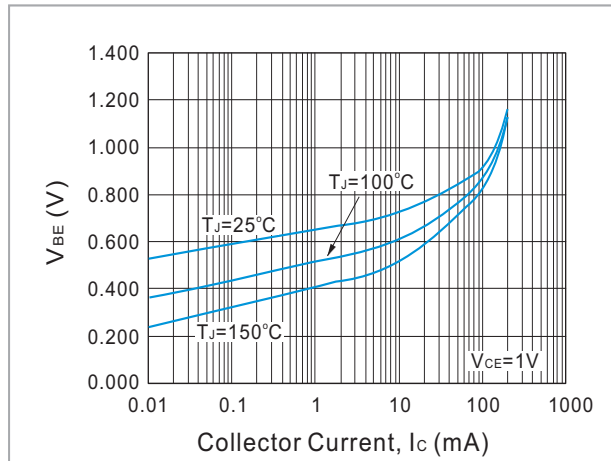

**Fig. 2. Typical  $V_{BE}$  vs. Collector Current**

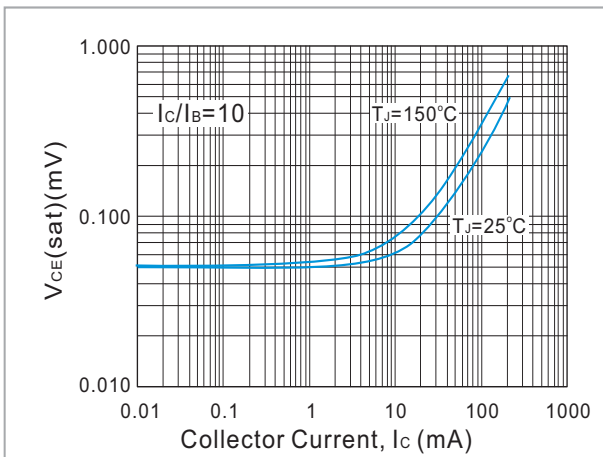

**Fig. 3. Typical  $V_{CE(sat)}$  vs. Collector Current**

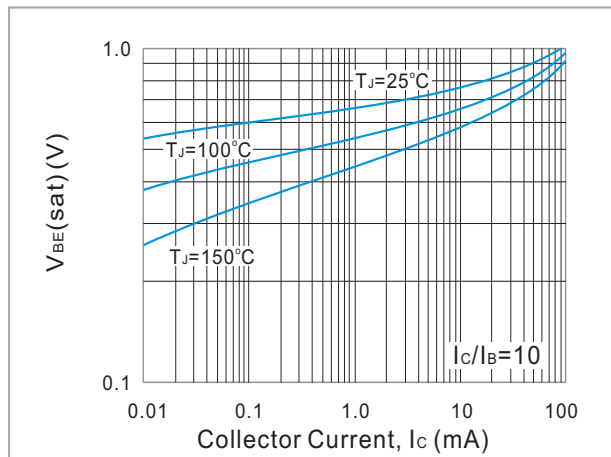

**Fig. 4. Typical  $V_{BE(sat)}$  vs. Collector Current**

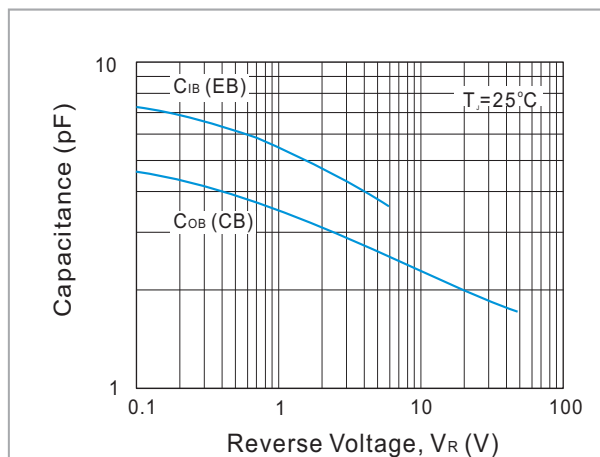
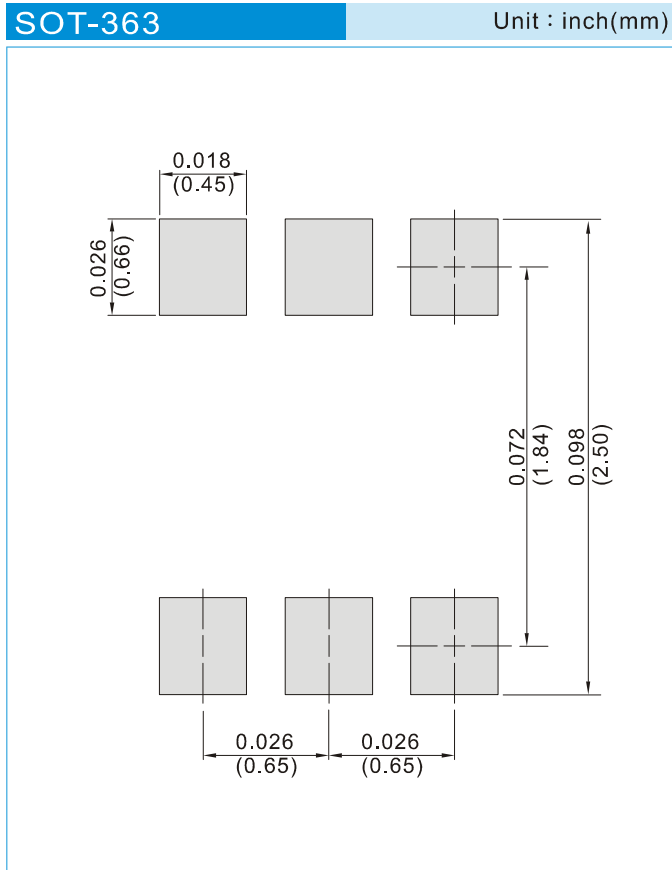

**Fig. 5. Typical Capacitances vs. Reverse Voltage**



# DMMT3904W

## MOUNTING PAD LAYOUT



## ORDER INFORMATION

- Packing information  
T/R - 10K per 13" plastic Reel  
T/R - 3K per 7" plastic Reel



# DMMT3904W

## Part No\_packing code\_Version

DMMT3904W\_R1\_00001

DMMT3904W\_R2\_00001

For example :

**RB500V-40\_R2\_00001**



Packing Code <b>XX</b>				Version Code <b>XXXXX</b>		
Packing type	1 <sup>st</sup> Code	Packing size code	2 <sup>nd</sup> Code	HF or RoHS	1 <sup>st</sup> Code	2 <sup>nd</sup> ~5 <sup>th</sup> Code
Tape and Ammunition Box (T/B)	A	N/A	0	HF	0	serial number
Tape and Reel (T/R)	R	7"	1	RoHS	1	serial number
Bulk Packing (B/P)	B	13"	2			
Tube Packing (T/P)	T	26mm	X			
Tape and Reel (Right Oriented) (TRR)	S	52mm	Y			
Tape and Reel (Left Oriented) (TRL)	L	PANASERT T/B CATHODE UP (PBCU)	U			
FORMING	F	PANASERT T/B CATHODE DOWN (PBCD)	D			



## DMMT3904W

---

### Disclaimer

- Reproducing and modifying information of the document is prohibited without permission from Panjit International Inc..
- Panjit International Inc. reserves the rights to make changes of the content herein the document anytime without notification. Please refer to our website for the latest document.
- Panjit International Inc. disclaims any and all liability arising out of the application or use of any product including damages incidentally and consequentially occurred.
- Panjit International Inc. does not assume any and all implied warranties, including warranties of fitness for particular purpose, non-infringement and merchantability.
- Applications shown on the herein document are examples of standard use and operation. Customers are responsible in comprehending the suitable use in particular applications. Panjit International Inc. makes no representation or warranty that such applications will be suitable for the specified use without further testing or modification.
- The products shown herein are not designed and authorized for equipments requiring high level of reliability or relating to human life and for any applications concerning life-saving or life-sustaining, such as medical instruments, transportation equipment, aerospace machinery et cetera. Customers using or selling these products for use in such applications do so at their own risk and agree to fully indemnify Panjit International Inc. for any damages resulting from such improper use or sale.
- Since Panjit uses lot number as the tracking base, please provide the lot number for tracking when complaining.